



# **Commercial Lunar Propellant Architecture**

A Collaborative Study of Lunar Propellant Production

To the Memory of:

**Dr. Paul D. Spudis (1952–2018)**

Dr. Spudis earned his master's degree from Brown University and his Ph.D. from Arizona State University in Geology with a focus on the Moon. His career included work at the US Geological Survey, NASA, John Hopkins University Applied Physics Laboratory, and the Lunar and Planetary Institute advocating for the exploration and the utilization of lunar resources. His work will continue to inspire and guide us all on our journey to the Moon.

*“By going to the Moon we can learn how to extract what we need in space from what we find in space. Fundamentally that is a skill that any spacefaring civilization has to master. If you can learn to do that, you've got a skill that will allow you to go to Mars and beyond.”*

## Authors

*David Kornuta, United Launch Alliance, CisLunar Project Lead<sup>1</sup>*  
*Angel Abbud-Madrid, Colorado School of Mines, Professor of Space Resources*  
*Jared Atkinson, Honeybee Robotics, Senior Geophysical Engineer*  
*Jonathan Barr, United Launch Alliance, Program Manager*  
*Gary Barnhard, Xtraordinary Innovative Space Partnership, CEO*  
*Dallas Bienhoff, Cislunar Space Development Company LLC, Founder*  
*Brad Blair, NewSpace Analytics, Managing Partner*  
*Vanessa Clark, Atomos Nuclear and Space, Chief Executive and Technology Officer*  
*Justin Cyrus, Lunar Outpost, CEO*  
*Blair DeWitt, Lunar Station Corporation, CEO and Co-Founder*  
*Chris Dreyer, Colorado School of Mines, Professor of Space Resources*  
*Barry Finger, Paragon Space Development Corporation, Chief Engineer*  
*Jonathan Goff, Altius Space Machines, President and CEO*  
*Koki Ho, University of Illinois at Urbana-Champaign, Professor of Aerospace Engineering*  
*Laura Kelsey, Paragon Space Development Corporation, Principal Investigator*  
*Jim Keravala, OffWorld Inc., CEO*  
*Bernard Kutter, United Launch Alliance, Chief Scientist*  
*Philip Metzger, University of Central Florida, Planetary Scientist*  
*Laura Montgomery, Catholic University's Columbus School of Law, Professor of Space Law*  
*Phillip Morrison, Honeybee Robotics, Systems Engineer*  
*Clive Neal, University of Notre Dame, Professor of Planetary Geology*  
*Erica Otto, United Launch Alliance, CisLunar Economics Analyst*  
*Gordon Roesler, Robots in Space LLC, President*  
*Jim Schier, NASA HQ, SCAN Chief Architect*  
*Brandon Seifert, Atomos Nuclear and Space, Chief Marketing and Strategy Officer*  
*George Sowers, Colorado School of Mines, Professor of Space Resources*  
*Paul Spudis, Lunar and Planetary Institute, Senior Staff Scientist*  
*Mark Sundahl, Cleveland State University, Cleveland-Marshall School of Law Professor*  
*Kris Zacny, Honeybee Robotics, VP & Director of Exploration Technology*  
*Guangdong Zhu, National Renewable Energy Laboratory, Senior Researcher*

---

<sup>1</sup> Project Coordinator



## **Executive Summary<sup>2</sup>**

---

<sup>2</sup> Section Authors: Gordon Roesler, Robots in Space LLC, President; and David Kornuta, United Launch Alliance, CisLunar Project Lead

Aside from Earth, the inner solar system is like a vast desert where water and other volatiles are scarce. An old saying is, “In the desert, gold is useless and water is priceless.” While water is common on Earth, it is of very high value in space. Science missions to the Moon have provided direct evidence that regions near the lunar poles, which are permanently in shadow, contain substantial concentrations of water ice. On the lunar surface, water itself is critical for human consumption and radiation shielding, but water can also be decomposed into hydrogen and oxygen via electrolysis. The oxygen thus produced can be used for life support, and hydrogen and oxygen can be combusted for rocket propulsion. Due to the Moon’s shallow gravity well, its water-derived products can be exported to fuel entirely new economic opportunities in space.

This paper is the result of an examination by industry, government, and academic experts of the approach, challenges, and payoffs of a private business that harvests and processes lunar ice as the foundation of a lunar, cislunar (between the Earth and the Moon), and Earth-orbiting economy. A key assumption of this analysis is that all work—construction, operation, transport, maintenance and repair—is done by robotic systems. No human presence is required.

Obtaining more data on conditions within the shadowed regions is vital to the design of a lunar ice processing plant. How much water is actually present, and at what percentage in the lunar regolith? How firm or soft are the crater bottoms, and how will that affect surface transportation? How deep is the ice resource, and in what state is it deposited amongst the regolith? These and other questions must be answered by precursor prospecting and science missions.

A wide range of potential customers for the hydrogen and oxygen products has been identified. They can be used to fuel reusable landers going back and forth between the lunar surface and lunar orbit. They can make travel to Mars less expensive if the interplanetary vehicle can be refueled in cislunar space prior to departure. Operations closer to Earth can also benefit from this new, inexpensive source of propellant. Refueling in Low Earth Orbit can greatly improve the size, type, and cost of missions to Geosynchronous Earth Orbit and beyond. This study has identified a near term annual demand of 450 metric tons of lunar derived propellant equating to 2,450 metric tons of processed lunar water generating \$2.4 billion of revenue annually.

Unlike terrestrial mining operations that utilize heavy machinery to move resources, the mass constraints of a lunar polar water mine are highly restrictive because of delivery cost. A revolutionary concept has been introduced that solves this issue. It has been discovered that instead of excavating, hauling, and processing, lightweight tents and/or heating augers can be used to extract the water resource directly out of the regolith in place. Water will be extracted from the regolith by sublimation—heating ice to convert it into water vapor without going through the liquid phase. This water vapor can then be collected on a cold surface for transport to a processing plant where electrolysis will decompose the water into its constituent parts (hydrogen and oxygen).

To achieve production demand with this method, 2.8 megawatts of power is required (2 megawatts electrical and 0.8 megawatts thermal). The majority of the electrical power will be needed in the processing plant, where water is broken down into hydrogen and oxygen. This substantial amount of power can come from solar panels, sunlight reflected directly to the extraction site, or nuclear power. Because the bottoms of the polar craters are permanently shadowed, captured solar energy must be transported from locations of sunlight (crater rim) via power beaming or power cables. Unlike solar power sources, nuclear reactors can operate at any location; however, they generate heat that must be utilized or rejected that may be simplified if located in the cold, permanently shadowed craters.

The equipment needed for this lunar propellant operation will be built from existing technologies that have been modified for the specific needs on the Moon. Surprisingly little new science is required to build this plant. Extensive testing on Earth will precede deployment to the Moon, to ensure that the robotics, extraction, chemical processing and storage all work together efficiently. The contributors to this study are those who are currently developing or have already developed the equipment required to enable this capability. From a technological perspective, a lunar propellant production plant is highly feasible.

Now is the time to establish the collaborations, partnerships, and leadership that can make this new commercial enterprise a reality. Currently, no one company has all of the capabilities necessary to build the lunar plant, but the capabilities all exist within United States aerospace industry and others (such as the chemical industry). It is necessary that new or existing competing companies establish the leadership needed to coordinate the variety of technologies required for a fully integrated Commercial Lunar Propellant Architecture. Free market competition among these companies will aid in driving down costs, promoting innovation, and expanding the market. To justify such action, a secure customer base, solid business case, and high fidelity economic model is required. This too will help secure the investment required for development and implementation.

The initial investment for this operation has been estimated at \$4 billion, about the cost of a luxury hotel in Las Vegas. With this investment however, a scalable market can be accessed. As refueling decreases in-space transportation costs, entirely new business and exploration opportunities will emerge with potential to vastly benefit the economies of Earth. Even with the early customers identified within this study, it has been determined that this could be a profitable investment with excellent growth opportunities.

The United States Government has critical roles to play in the development of this commercial capability as well. Government science/prospecting and communications missions to the Moon can be very helpful in both the development and operational phases of the business. Government laboratories can contribute some of their technologies and help facilitate integrated systems tests of a terrestrial pilot plant. Government must also work to fill the gaps in international law regarding property rights on celestial bodies such as the Moon. In addition, between Earth orbit, Moon, and Mars missions, government could be an important anchor customer for the resource, stimulating the private sector into action with proposed demands and price points while improving its mission costs and capabilities.

This study demonstrates both the technical and economic feasibility of establishing a commercial lunar propellant production capability. It provides recommendations to interested government and private organizations and defines a path to implementation; and explains that by doing so the United States will fuel a new age of economic expansion, sustained space exploration, settlement, and American leadership in space.

## **Acronyms**

ACCESS – Assembly Concept for Construction of Erectable Space Structure  
ACS – Attitude Control System  
AI – Artificial Intelligence  
AMOS – Air Force Maui Optical Station  
APU – Auxiliary Power Unit  
ASI – Italian Space Agency  
ATHLETE – All-Terrain Hex-Limbed Extra-Terrestrial Explorer  
AVG – Average  
BAA – Broad Agency Announcement  
BEO – Beyond Earth Orbit  
BFR – Big Falcon Rocket  
BPA – Brine Processor Assembly  
C&N – Communication and Navigation  
CAD – Computer Aided Drafting  
CAIV – Cost as an Independent Variable  
CATALYST – Cargo Transportation and Landing by Soft Touchdown  
CCSDS – Consultative Committee for Space Data Systems  
CE&R – Concept Evaluation and Refinement  
CER – Cost-Estimating Relationship  
CLPS – Commercial Lander for Payload Services  
CNES – French Space Agency  
CNSA – China National Space Administration  
COTS – Commercial Orbital Transportation Services  
CRIWE – Contaminant Robust In-Situ Water Extraction  
CSA – Canadian Space Agency  
CSDC – Cislunar Space Development Company  
CSM – Colorado School of Mines  
CSP – Commercial Service Providers  
CSP – Concentrating Solar Power  
CSTS – Commercial Space Transportation Study  
CT – Cold Trap  
DARPA – Defense Advanced Research Projects Agency  
DC – Direct Current  
DLR – German Aerospace Center  
DoD – Department of Defense  
DOE – Department of Energy  
DOF – Degrees of Freedom  
DSA – Deep Space Antennas  
DSN – Deep Space Network  
DSS – Deployable Space Systems  
DTC – Design to Cost  
DTN – Delay/Disruption Tolerant Networking  
EIS – Environmental Impact Statement  
EM-2 – Exploration Mission 2  
EMBARC – Electropermanant Magnetic Boom Assisted Rendezvous and Capture  
EML1 – Earth-Moon Lagrange Point 1

EROI – Energy-Return-On-energy-Invested  
ESA – European Space Agency  
ESOC – European Space Operations Centre  
ESTRACK – European Space Tracking  
FAA – Federal Aviation Administration  
FLEX – Flexible Lunar Explorer  
FREND – Front-end Robotic Enabling Near-term Demonstration  
FY – Fiscal Year  
GEO – Geosynchronous Earth Orbit  
GH2 – Gaseous Hydrogen  
GLXP – Google Lunar X-Prize  
GNSS – Global Navigation Satellite System  
GO2 – Gaseous Oxygen  
GPS – Global Positioning System  
GSO – Geosynchronous Orbit  
GTO – Geostationary or Geosynchronous Transfer Orbit  
HEU – Highly Enriched Uranium  
HOPA – Hydrogen Oxygen Production Assembly  
HQ - Headquarters  
HTF – Heat Transfer Fluid  
iBOSS – Intelligent Building Blocks for On-Orbit Satellite Servicing and Assembly  
ICG - International Committee on Global Navigation Satellite Systems  
IHOP – ISRU-derived water purification and Hydrogen Oxygen Production  
INSRP – Interagency Nuclear Safety Review Panel  
IOAG – Interagency Operations Advisory Group  
IP – Internet Protocol  
IR – Infrared  
IRA – Integrated-water Recovery Assembly  
ISA – Israel Space Agency  
ISECG – International Space Exploration Coordination Group  
ISRO – Indian Space Research Organization  
ISRU – In-Situ Resource Utilization  
ISS – International Space Station  
IST – Integrated System Test  
IVF – Integrated Vehicle Fluids  
IWP – Ionomer-membrane Water Processing  
JAXA – Japanese Aerospace Exploration Agency  
JPL – Jet Propulsion Laboratory  
JSC – Johnson Space Center  
KARI – Korean Aerospace Research Institute  
LADEE – Lunar Atmosphere and Dust Environment Explorer  
LAMP – Lyman Alpha Mapping Project  
LAN – Local Area Network  
LAVA – Lunar Advanced Volatiles Analysis  
LCA – Lunar Communications Architecture  
LCRD – Laser Communications Relay Demonstration  
LCROSS – Lunar CRater Observation and Sensing Satellite



LCT – Lunar Communications Terminal  
LEAG – Lunar Exploration Analysis Group  
LEND – Lunar Exploration Neutron Detector  
LEO – Low Earth Orbit  
LEU – Low Enriched Uranium  
LH2 – Liquid Hydrogen  
LIDAR – Light Detection and Radar  
LITA – Life in the Atacama  
LLCD – Lunar Laser Communications Demonstration  
LLO – Low Lunar Orbit  
LO2 – Liquid Oxygen  
LOLA – Lunar Orbiter Laser Altimeter  
LOS – Line of Site  
LOTank – Lunar Outpost Tank  
LOX – Liquid Oxygen  
LPI – Lunar and Planetary Institute  
LRO – Lunar Reconnaissance Orbiter  
LRS – Lunar Relay Satellite  
LS – Lunar Surface  
M<sup>3</sup> – Moon Mineralogy Mapper  
MAC – Magnetoshell Aerocapture  
MDA – McDonald, Dettwiler, and Associates  
MISWE – Mobile In-Situ Water Extractor  
MLI – Multi-Layer Insulation  
MMRTG – Multi-Mission Radioisotope Thermoelectric Generator  
MPFL – Mechanically Pumped Fluid Loop  
MSL – Mars Science Laboratory  
MT – Metric Tons  
MW – Megawatt  
NAFCOM – NASA and Air Force Cost Model  
NASA – National Aeronautics and Space Administration  
NEN – Near Earth Network  
NEO – Near-Earth Object  
NEP – Nuclear Electric Propulsion  
NEXT – NASA Exploration Team  
NextSTEP – Next Space Technologies for Exploration Partnerships  
NGIS – Northrop Grumman Innovation Systems  
NIAC – NASA Innovative Advanced Concepts  
NINJAR – NASA Intelligent Jigging and Assembly Robot  
NIRVSS – Near InfraRed Volatiles Spectrometer Subsystem  
NORCAT – Northern Centre for Advanced Technology  
NPV – Net Present Value  
NRC – Non-Recurring Cost  
NREL – National Renewable Energy Lab  
NRHO – Near Rectilinear Halo Orbit  
NRL – Naval Research Laboratory  
NSS – Neutron Spectrometer Subsystem

NTP – Network Time Protocol  
NTP – Nuclear Thermal Propulsion  
O2O – Optical to Orion  
OASIS – Orbital Aggregation of Space Infrastructure Systems  
ODE – Ordinary Differential Equation  
OGS-2 – Optical Ground Station 2  
OVEN – Oxygen and Volatile Extraction Node  
PD – Permanent Darkness  
PLA – Permanently Lit Area  
PNT – Position, Navigation and Timing  
PPM – Parts Per Million  
PPP – Public-Private Partnership  
PSR – Permanently Shadowed Regions  
PV – Photovoltaic  
PVEx – Planetary Volatiles Extractor  
RASC – Revolutionary Aerospace Systems Concepts  
RC – Recurring Cost  
RF – Radio Frequency  
RFP – Request for Proposal  
ROR – Rate of Return  
RORSAT – Radar Ocean Reconnaissance Satellite  
ROSA – Roll Out Solar Array  
RP – Resource Prospector  
RSGS – Robotic Servicing of Geosynchronous Satellites  
RTD – Resistance Temperature Detector  
RTG – Radioisotope Thermoelectric Generator  
SAA – Space Act Agreement  
SANSA – South African National Space Agency  
SBIR – Small Business Innovation Research  
SBSP – Space Based Solar Power  
SEP – Solar Electric Propulsion  
SFCG – Space Frequency Coordination Group  
SME – Subject Matter Expert  
SNAP – Space Nuclear Auxiliary Power  
SSL – Space Systems Loral  
SSPB – Space-to-Space Power Beaming  
SSRMS – Space Station Remote Manipulator System  
STARLITE – Space Transportation Architectures and Refueling for Lunar and Interplanetary Travel and Exploration  
STPSat-6 – Space Technology Program Satellite 6  
STS – Space Transportation System  
SWaP – Size, Weight and Power  
TD<sup>3</sup> – Technology Development, Demonstration, and Deployment  
TRIDENT – The Regolith and Ice Drill for Exploration of New Terrains  
TRL – Technology Readiness Level  
UAESA – United Arab Emirates Space Agency  
UCF – University of Central Florida

UIUC – University of Illinois at Urbana-Champaign  
UKSA – United Kingdom Space Agency  
ULA – United Launch Alliance  
UN – United Nations  
US – United States  
USG – United States Government  
VASIMR – Variable Specific Impulse Magnetoplasma Rocket  
WDD – Water Droplet Demonstration  
WEH – Water-Equivalent Hydrogen  
WIPE – Water, ISRU-derived, Purification Equipment  
XISP – Xtraordinary Innovative Space Partnership

## Table of Content

Authors.....	iii
Executive Summary .....	iv
Acronyms.....	vii
Table of Content .....	xii
List of Figures.....	xvi
Introduction.....	1
Background and Need.....	2
Study Methodology.....	2
Assumptions and Ground Rules.....	6
Document Organization.....	6
Prospecting.....	8
Lunar Volatile Deposits .....	9
Solar Wind Implanted Volatiles.....	9
Endogenous Lunar Volatiles.....	9
Polar Volatile Deposits .....	10
Exploring in Permanent Darkness.....	13
Methodology.....	15
Surface and Subsurface Sampling.....	16
Mining Operations .....	19
Active Extraction .....	20
Rover Mounted Drills .....	20
Subsurface Heating .....	22
Passive Extraction.....	23
Thermal Mining .....	23
Sublimation and Vapor Transport.....	25
Balancing the rates .....	25
Sublimation Power Requirements.....	27
Thermal Mining Sizing .....	28
Processing .....	28
Cold Trap .....	29
Water Purification.....	31
Electrolysis.....	32
Integrated System Solution .....	33
Propellant Storage.....	34
Repurposed Surface Storage Tanks .....	35
In-Space Specifications.....	35
Power .....	39
Requirements .....	40
Overview.....	40
Photovoltaics.....	41
Wired Power Transmission.....	41
Power Beaming.....	42
Heliostat.....	42
On the Moon .....	43
Nuclear Fission .....	44
Megawatt Power on Lunar Surface.....	46

Non-Technical System Considerations .....	48
Robotic Services .....	50
Overview .....	51
Universal Platform .....	52
Lunar Surface Construction, Maintenance, and Repair .....	52
In Space.....	57
Grappling Arms .....	57
Rendezvous and Capture.....	60
“In-Door” Robotics .....	64
Communication and Navigation .....	65
Overview.....	66
Lunar Surface.....	68
In Space.....	69
From Earth .....	71
Moon Navigational Services.....	74
Transportation .....	77
Emplacement.....	78
Delivery Capability .....	78
Bootstrapping Deployment .....	78
Landing Site Ejecta Mitigation .....	79
Lunar Surface.....	81
Surface Material Transport .....	81
Surface Mobility .....	83
Lunar Surface to Orbit .....	86
Chemical Propulsion.....	86
Moon to LEO Cost Savings .....	88
Propellantless Ascent.....	88
Electromagnetic Launch .....	88
Rotary Sling-Tethers .....	89
In Space.....	91
Chemical Propulsion.....	91
Nuclear Thermal Propulsion .....	92
Nuclear Electric Propulsion .....	92
Aerobraking/Aerocapture for LEO Delivery .....	95
Business Case.....	98
Willingness to Pay .....	99
Customers .....	99
Demand.....	100
Propellant Pricing.....	102
Lunar Surface and EML1 Customers.....	102
LEO Customers.....	102
Mine Sizing.....	105
Economic Analysis .....	106
Discounted Cash Flow Model.....	106
Seven Scenarios .....	106
Business Risks .....	110
Historic Market Research .....	111

Cost Modeling.....	116
Historical ISRU Cost Estimates.....	117
Heritage Costing.....	120
Cost as an Independent Variable.....	121
Cost Reduction.....	122
Standards as Cost Savings.....	125
Legal.....	127
Rights and Regulation.....	128
Ownership Rights.....	128
Priority Rights to Mining Claims.....	128
Noninterference.....	128
Regulatory Clarity without Excessive Regulation.....	129
The Hague Space Resources Governance Working Group.....	129
Appropriations.....	129
Space as a Commons.....	130
Bar on National Appropriation.....	130
Imputation of Treaty Prohibitions on State Actors to Private Actors.....	130
Adverse Possession: A Way Forward.....	131
Benefits.....	132
Enabled Industries.....	133
An Emerging Cislunar Marketplace.....	133
Utilities in Space.....	135
Supporting Human Settlement.....	135
Industrialization of Space.....	137
Science Benefits.....	138
Long-Term Benefits.....	140
Energy.....	140
Computing and Data.....	142
Existential Threats.....	142
National Security and Global Stability.....	143
Grand Science and Exploration.....	143
Recommendations.....	145
For Government.....	146
Develop Precursor “Prospecting” Missions.....	146
Develop Prototype Pilot Plant on Earth.....	147
Institute Public Private Partnership.....	147
Promote Healthy Competition.....	148
Facilitate Technology Development.....	149
Institute Law for Property Ownership.....	150
For Private Sector.....	150
Establish Leadership within the Private Sector.....	150
Strategize for Investment Appeal.....	151
Promote Investment Opportunities.....	152
Active Role in Space Law.....	153
Technical.....	153
Leverage Existing Systems.....	154
Apply Automation.....	154

Establish Standards .....	154
Path Forward.....	155
References.....	158

## List of Figures

Figure 1: Lunar Propellant Architecture Participants .....	3
Figure 2: Functional Flow Diagram of Lunar Surface Operations .....	4
Figure 3: Functional Flow Diagram of In-Space and Earth Operations .....	5
Figure 4: Locations of Pyroclastic Glasses with $\geq 300$ ppm (0.27 wt.%) H <sub>2</sub> O Signatures .....	9
Figure 5: Representation of the South [(a) and (c)] and North [(b) and (d)] Poles of the Moon .....	11
Figure 6: WEH Estimates from the LRO-LEND Neutron Data .....	12
Figure 7: Presence of Surface Water Ice in PSRs at the North and South Polar Regions of the Moon.....	13
Figure 8: Lunar Polar Lighting Studies.....	15
Figure 9: TRIDENT Drill and Deployment System .....	17
Figure 10: Lunar Resource Prospector RP15.....	18
Figure 11: PVEx System Mounted to LITA .....	21
Figure 12: MISWE Rover with Drill .....	21
Figure 13: Lunar Regolith Subsurface Heating Profile.....	23
Figure 14: System Architecture (Plan View).....	24
Figure 15: Thermal Mining Concept .....	25
Figure 16: Thermal Mining Ice Extraction Process .....	26
Figure 17: Power to Sublimate by Concentration.....	27
Table 1: Thermal Mining Design for 4wt% and 30wt% Regions.....	28
Figure 18: IHOP System Flow Diagram.....	29
Figure 19: Ice Collection Plates of a Commercial CT .....	30
Table 2: Lunar Water Contaminant Loading .....	30
Figure 20: Customized IWP Membrane Module .....	31
Figure 21: Giner 72-Cell Electrolyzer Stack.....	32
Figure 22: Conceptual Packaging of IHOP with Mobile Robotic Transports .....	33
Figure 23: LEO Propellant Depot .....	36
Figure 24: Lunar Orbit Propellant Depot.....	36
Table 3: Cislunar Space Propellants .....	37
Figure 25: Working Principle of Heliostats .....	43
Figure 26: Conceptual Power System Using Heliostats at a Moon Crater .....	44
Table 4: Current USG Nuclear Programs Compared to Lunar Production Needs.....	45
Table 5: (Right) Transportation of Various Power Systems to Cislunar 1000 Propellant Plant Depot .....	45
Figure 27: (Left) Reactor Specific Mass vs. Electric Power.....	46
Table 6: Reactor technologies.....	47
Figure 28: OffWorld Universal Robotic Platform .....	52
Figure 29: Concept for Construction of Blast Shield and Roadway Using Regolith.....	53
Figure 30: NINJAR 2.0, NASA Robotic Space Assembly Experiment .....	54
Figure 31: Assembly of the ACCESS Experiment during STS-61B.....	55
Figure 32: Robotic Construction of a Trestle Bridge.....	55
Figure 33: Canadarm 3 on Lunar Orbiting Facility .....	57
Figure 34: SSRMS on the ISS Reaching into the Dragon External Cargo Bay.....	58
Figure 35: Dragon Capsule on Approach to the ISS.....	59
Figure 36: Illustration of the DARPA/SSL RSGS Vehicle .....	60
Figure 37: Bulldog LEO Satellite Servicing Vehicle.....	61
Figure 38: DogTag™ Cooperative Grappling Fixture.....	61
Figure 39: Artist's Conception of a LEO Propellant Depot for Smallsat Launch Vehicles .....	62
Figure 40: Illustration of a Soft-Capture Rendezvous with Tanker .....	62



Figure 41: Cryogenic Transfer Coupling .....	63
Figure 42: Internal Robotics for Mission Support .....	64
Figure 43: Queqiao, the Chang'e 4 Relay .....	66
Figure 44: IOAG Lunar Communications Architecture .....	67
Table 7: Data and PNT Services Provided in the Lunar Communications Architecture .....	68
Figure 45: Lunar Surface Comms Concept Featuring Wired LAN and Lunar Comms Terminal .....	69
Table 8: Current and Planned Lunar Relay Capabilities.....	70
Figure 46: Laser Communications Payload design for Orion crew vehicle on EM-2 .....	71
Table 9: Current and Planned Lunar C&N Networks.....	72
Figure 47: Optical Ground Station 2 installation on roof of Air Force Maui Optical Station .....	74
Figure 48: Lunar Station Corporation's MoonWatcher Constellation.....	74
Figure 49: LSC's Rendering of MoonWatcher CubeSat .....	75
Figure 50: Lunar Station Corporation's MoonHacker Data Analytics .....	75
Figure 51: LSC's MoonHacker 3D Model Showing Lunar Forecasted Meteor Storm .....	76
Figure 52: LSC's MoonHacker 3D using mineral deposits metadata layer.....	76
Figure 53: Example of Bootstrapping ISRU Deployment Method.....	79
Figure 54: Piping System for Carrying Material Out of Crater .....	82
Figure 55: MSL Articulated Wheels and Traction Treads.....	83
Figure 56: Wheel Damage on MSL .....	84
Figure 57: Lightweight Elevated Track and Vehicle Concept for Long-Term Transportation .....	85
Figure 58: Elevated Track Layout for Long-Term Transportation around Site.....	86
Figure 59: Cislunar Space Development Company's Moon Shuttle .....	87
Figure 60: Sling Tether Launcher Illustration.....	89
Figure 61: SpinLaunch Circular Mass Accelerator Illustration .....	90
Figure 62: Advanced Centaur Upper Stage .....	91
Figure 63: Advanced Centaur in Flight.....	92
Figure 64: Power Technology Regimes for Optimal Specific Power.....	93
Figure 65: The Atomos Nuclear Electric Propulsion Spacecraft .....	94
Table 10: In-Space Transportation Comparison for Lunar Orbit to LEO.....	94
Figure 66: Reusable Lunar Orbital Transfer Vehicle Concept Using Aerocapture .....	96
Figure 67: Vacuum Chamber Test of a 6U Cubesat-Scale MAC Demo System.....	97
Table 11: Cost of propellant from Earth or the Moon .....	100
Figure 68: Initial Lunar Propellant Customers .....	101
Figure 69: Trade Routes and Economic Activities in Cislunar Space.....	103
Figure 70: Cost of Propellant in Cislunar Space.....	104
Table 12: Key Parameters for the LEO Propellant Business Case .....	104
Table 13: Comparison of Ice Mining Options .....	105
Figure 71: Screen-Shot of Economic Model GUI .....	106
Figure 72: Revenue and NPV for Each Scenario.....	109
Table 14: Required Subsidy for Seven Scenarios .....	109
Figure 73: LEO Business Case Discount Rate Sensitive .....	110
Table 15: On-orbit and Planetary Surface Markets Envisioned in 1994 CSTS .....	111
Table 16: Production Levels and Unit Costs for Lunar Propellant.....	112
Table 17: Development of Unit Costs for STARLITE 10-yr Lunar Architecture .....	113
Figure 74: Linearization of the Rocket Equation Due to Lunar ISRU.....	113
Table 18: Cost and Market Demand for Spaceworks SMR Model .....	114
Table 19: Costs, Revenues and Breakeven for Spaceworks Lunar ISRU Model .....	115

Figure 75: Propellant Forecast for LEO and L2 .....	116
Table 20: Cost Modeling Results from Various ISRU Studies.....	117
Table 21: Estimated cost vs. Analogy for Lunar ISRU Elements.....	118
Table 22: Cost Models for ISRU Elements that Could Support Constellation.....	119
Figure 76: USCM vs. SSCM Cost Model Comparison .....	120
Figure 77: The Space Spiral of Increasing Cost.....	121
Figure 78: CAIV Implementation and Flow .....	122
Table 23: Comparative Costs of Manufactured Systems .....	123
Figure 79: Stages of Exploration and Development in Cislunar Space .....	133
Figure 80: Heritage Space Commerce Market Segments and Size.....	134
Figure 81: Emerging Space Markets as Seen by Analysts at Bank of America Merrill Lynch.....	136
Table 24: Space Population Forecast and Propellant Consumption Model .....	137
Figure 82: Lockheed Martin’s Mars Base Camp .....	137
Figure 83: NASA’s Principles for Sustainable Exploration .....	140
Figure 84: Growth of Computer Energy Usage Compared to World Energy Production .....	142
Table 25: Stages in the Development of a New Business Ecosystem .....	148



# Introduction

### **Background and Need<sup>3</sup>**

In the same way that exploration of our planet required mankind to adapt and learn to use local resources varying by continent, region, and climate, so too will mankind learn to find, extract, and use local resources to continue our expansion and exploration of space. The need for this adaptation is driven by the stark contrast between the relatively small amount of material that can be launched from Earth, and the enormous volume and diversity of resources available in space. Commercialization of space resources, enhanced by Public-Private Partnerships (PPP)s, capital investments, and new business models, represents the future of resource extraction industries.

As capabilities in space continue to grow with the advancement of technology, strategic planning and prioritization of resource exploration, it is imperative to guide policy and commercial development of space-based natural resources. In-Situ Resource Utilization (ISRU) represents the near future of the space industry, enabling the efficient use of resources both on Earth and in space, as well as continued expansion and development of human presence outside of our planet. Technologies developed and refined for ISRU will continue to deliver additional benefits to Earth-bound industries, as demonstrated by the ubiquity of modern technologies first developed for space exploration programs. Thus, ISRU is an important area for investment and rapid development in the near future.

The most pressing need for resources in space is that of fuel; transporting cargo and humans in space requires a vast amount of propellant, and launching the full mass of propellant needed for long-term space missions from the Earth's surface places severe limitations on missions of all kinds. Thus, developing an architecture for prospecting, mining, processing, storing, and transporting fuel products in space is the first critical step to creating a sustainable space development strategy. Between the abundance of resources available, relative proximity to the Earth, and decades of scientific study, the Moon presents an ideal objective for early-stage ISRU activities, providing a testing ground for the development of new methods and technologies as well as a platform for continued expansion to other planets and Near-Earth Objects (NEO)s.

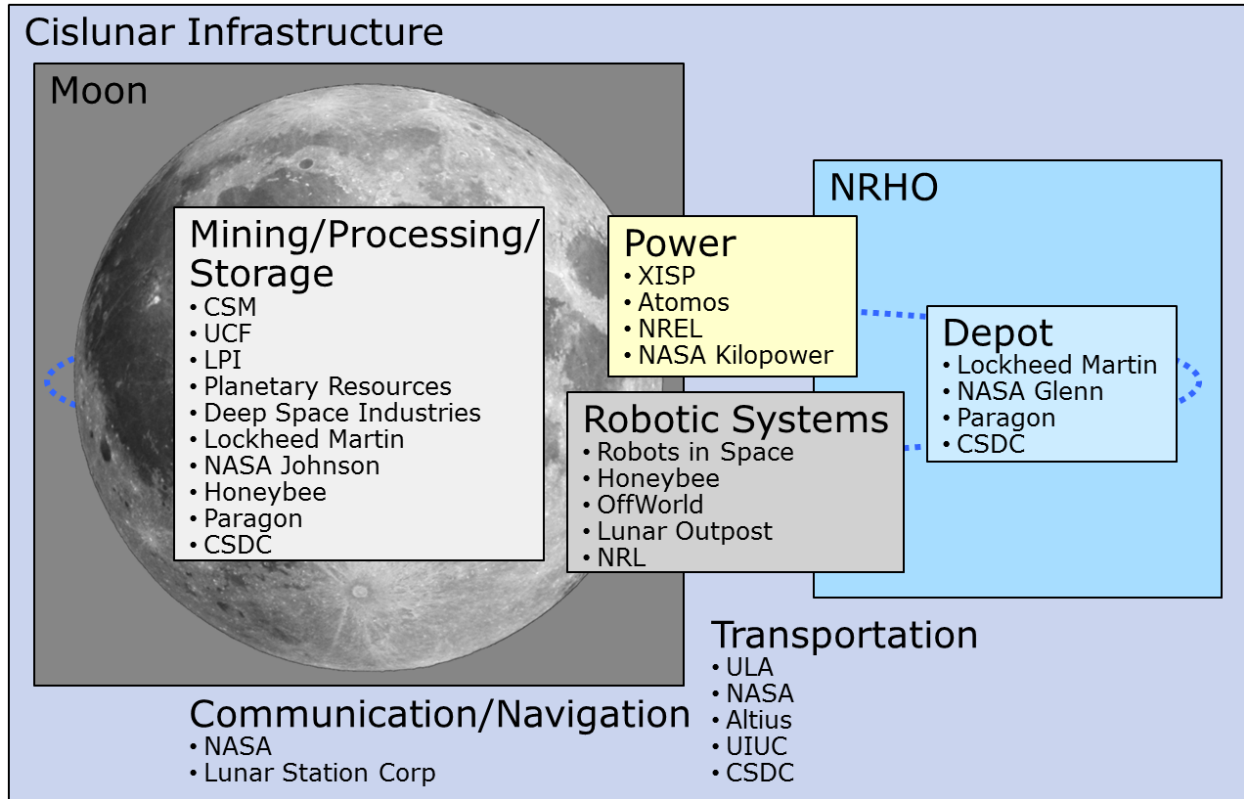
### **Study Methodology<sup>4</sup>**

The following study represents the collaborative input from some 40 individuals across 25 organizations to identify the technical and economic feasibility of developing a lunar propellant production plant. Academic, private, and government institutions worked together to identify hardware solutions, quantify near term customers and demand, navigate financial obstacles, and to explore the new industries and scientific findings that would be unlocked by utilizing lunar water ice deposits. It was discovered, that for nearly every major component of the lunar propellant architecture there was already organizations developing the technology and hardware required to meet those function. Figure 1 shows several of the participating organizations and the systems in which they are currently developing hardware solutions. Subsequent sections within this document will outline in detail the hardware solutions that these organizations bring to the table.

---

<sup>3</sup> Section Author: Justin Cyrus, Lunar Outpost, CEO

<sup>4</sup> Section Author: David Kornuta, United Launch Alliance, CisLunar Project Lead



**Figure 1: Lunar Propellant Architecture Participants**

In order to approach the large task of defining a commercial lunar propellant architecture, tools from traditional systems engineering were implemented. As such, the study was initiated by performing a needs analysis. It was determined that several systems being invested in today by private and government organizations would greatly benefit from the utilization of propellant production at the Moon. Each of these developing customers of a lunar propellant production plant were able to quantify their demand, which can be found in the “Demand” section of this document. Based on input from those customers, it was determined that there will be an early need for nearly 1,640 Metric Tons (MT) of propellant per year on the lunar surface.

With an established need for lunar propellant production, the functional requirements were defined. The functional requirements were captured in the creation of a functional flow diagram. The functional flow diagram identifies the system functions while tracing the flow of ice from its source in Permanently Shadowed Regions (PSR) on the Moon, through processing, and all the way to the end user as propellant. At the highest level, the systems are outlined by the location in which it exists: the lunar surface, cislunar space, and Earth. In the case of Figure 2, the encompassing grey rectangle represents the lunar surface. The next level down represents the major systems: propellant processing, power, robotic services, communication/navigation, and the lunar mine. At the lowest level are the sub-system functional requirements (indicated by white boxes).

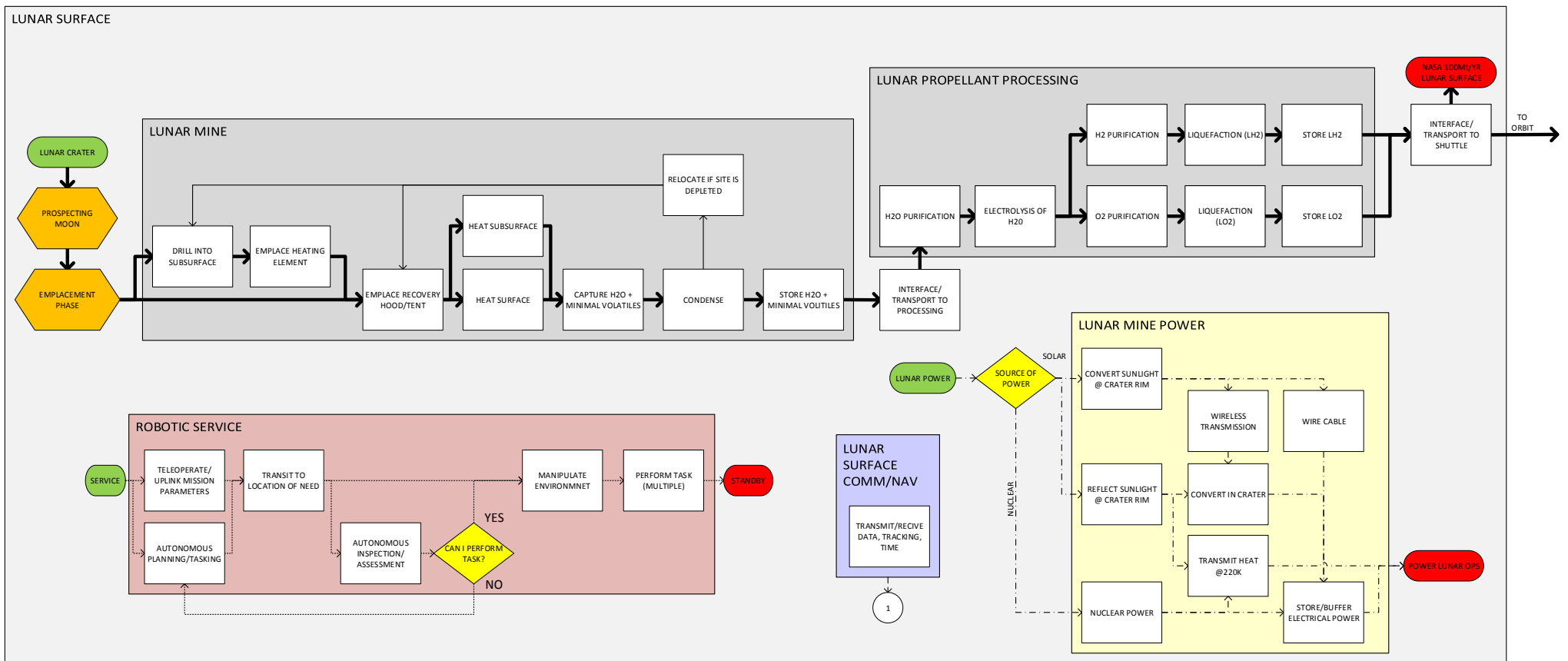


Figure 2: Functional Flow Diagram of Lunar Surface Operations



propellant production plant and the impacts it will have on future space operations and the United States industrial base.

### **Assumptions and Ground Rules<sup>6</sup>**

Although the presence of water ice on the lunar poles has been confirmed<sup>7</sup>, there are still a great number of unknowns about its abundance and physical state. Several science missions have provided<sup>8</sup> compelling details about the craters containing water ice. Most recently, the Lunar Reconnaissance Orbiter (LRO) detected<sup>9</sup> highly reflective patches within the craters indicative of frost concentrations. Other sources of data suggest<sup>10</sup> even wider distribution of water on the Moon. However, there are significant gaps in our understanding of exactly how much, where, and in what condition the water may be found.

The weight of evidence is that the lunar polar craters would be excellent locations for extracting commercially important amounts of water. This paper has been prepared by a group of experts working with a common model of how that water could be extracted, processed, and distributed for use. The common assumptions were:

- Six major infrastructure elements are required: mining/processing, propellant storage, power, robotic systems, communication/navigation, and transportation (in-space and on lunar surface)
- All construction and operation will be done by robotic systems
- A solar power plant and/or power beaming facility will rely on sunlight, so it must be located outside the PSR in a sunlit area
- Nuclear power plants can function within PSR but require mechanisms for heat rejection
- Extraction of the water will be by direct sublimation, so moving large amounts of regolith can be avoided
- Water will be broken down into hydrogen and oxygen, which will be liquefied for storage
- Low temperatures within the crater will be a challenge for robotic design, but will reduce power needs for storage by keeping the Liquid Hydrogen (LH2) and oxygen cold
- Only considered technology currently in development or already developed
- Operations must be economically viable for commercial sustainability

To make the facility economically viable, the value of resources it produces must exceed its cost, including the costs of development, launch, installation and operation.

### **Document Organization<sup>11</sup>**

This work is organized into sections detailing an architecture for lunar ISRU that leverages current technologies and economic trends into a comprehensive plan for near-term space development. Following this introduction, are several sections describing hardware solutions for mining, processing, storage, powering, robotically supporting, and transporting lunar derived propellant. Several of these sections are further broken down to categorize the specific type or location of their operations. Following these technical sections, is an in depth look at the business case for lunar propellant including demand, pricing, an economic analysis of various scenarios, and costs. This is followed by a detailed look at lunar mining from a legal and regulatory perspective. The Benefits section explores the industries that will be stimulated by this effort

---

<sup>6</sup> Section Author: Gordon Roesler, Robots in Space LLC, President

<sup>7</sup> <http://www.pnas.org/content/early/2018/08/14/1802345115>

<sup>8</sup> [https://nssdc.gsfc.nasa.gov/planetary/ice/ice\\_Moon.html](https://nssdc.gsfc.nasa.gov/planetary/ice/ice_Moon.html)

<sup>9</sup> <https://www.nasa.gov/feature/goddard/2017/nasa-orbiter-finds-new-evidence-of-frost-on-Moons-surface>

<sup>10</sup> <https://www.nasa.gov/feature/goddard/2018/on-second-thought-the-Moons-water-may-be-widespread-and-immobile>

<sup>11</sup> Section Authors: Justin Cyrus, Lunar Outpost, CEO; and David Kornuta, United Launch Alliance, CisLunar Project Lead



and forecasts both the near and long-term ramifications to the global economy, quality of life on Earth, and evolution of humankind. Finally, in the recommendations, a path to technology development and implementation is identified as well as strategic investment opportunities. Credit is given to authors with a footnote attached to the title of their sections. It is through their collaborative work that the complete story of the lunar propellant production can be told.



## **Prospecting**

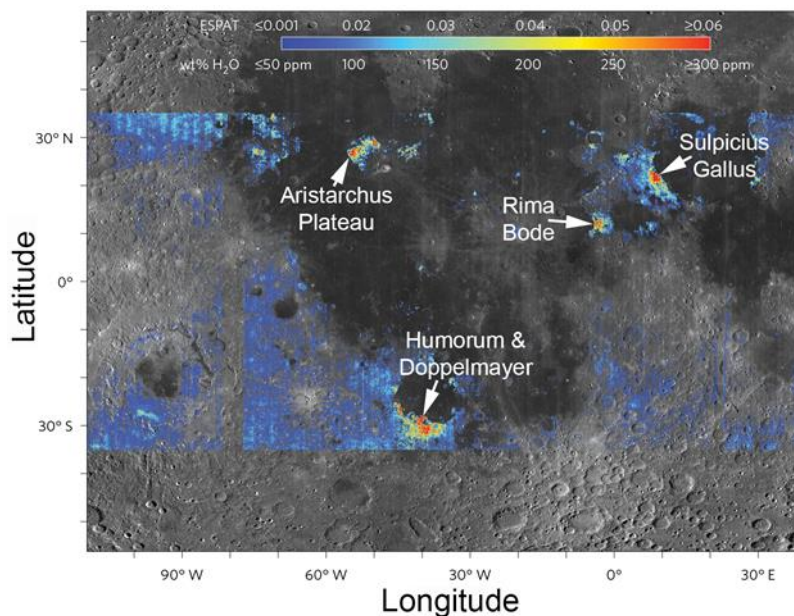
## Lunar Volatile Deposits<sup>12</sup>

### Solar Wind Implanted Volatiles

As the Moon is continually affected by the solar wind and other space radiation, the regolith contains elevated levels of volatile elements with the amount dependent upon length of exposure on the lunar surface. The most dominant solar wind volatile is hydrogen that can reduce FeO in minerals to metallic Fe and form OH- or H<sub>2</sub>O when impact energy facilitates the reduction reaction. Many regolith agglutinates (impact glass-welded mineral fragments) contain vesicles attesting to the volatile release on impact melt generation. Therefore, the longer regolith is exposed to the solar wind, the more implanted volatiles will build up in that regolith. The ferromagnetic resonance ( $I_s$ ) normalized to total iron content (represented as FeO) has been used to measure the relative exposure age of regolith [1] [2]. In the returned regolith samples there are positive correlations with solar wind-implanted species (e.g., H, He, C, N, Ar) [3].

### Endogenous Lunar Volatiles

Ever since the Apollo samples were returned, it was evident that the lunar interior did contain volatile species, but it was unclear exactly what those were. For example, vesicular basalts were returned (e.g., Apollo 15 samples 15556 and seat-belt rock 15016) and glass beads that were interpreted to be the result of gas-charged fire-fountain eruptions (e.g., Apollo 15 green glass 15426, Apollo 17 orange glass 74220). This gas was originally suggested to be rich in carbon monoxide (CO) [4].



**Figure 4: Locations of Pyroclastic Glasses with  $\geq 300$  ppm ( $0.27$  wt.%)  $H_2O$  Signatures<sup>13</sup>**

It wasn't until 37 years after the Apollo 15 green glass and 36 years after the Apollo 17 orange glass were collected that volatiles of S, F, Cl, and  $H_2O$  were shown to be diffusing out of the glass beads during eruption [5] and that significant reservoirs of these volatiles were present in at least parts of the lunar interior. Hauri et al. [6] [7] also showed that the source of the Apollo 15 and 17 pyroclastic glasses was as volatile-rich as the Earth's upper mantle. These results from Apollo samples led to a re-evaluation of orbital data from the Moon Mineralogy Mapper ( $M^3$ ) instrument on the Indian Chandrayaan-1 mission and showed

<sup>12</sup> Section Author: Clive Neal, University of Notre Dame, Professor of Planetary Geology

<sup>13</sup> Modified from Milliken and Li [8] where more details can be found

that many pyroclastic glass deposits on the lunar near side exhibited a hydration signature exceeding 300 ppm (0.27 wt.%) [8] (Figure 4).

### **Polar Volatile Deposits**

There are regions on the Moon that contain elevated volatile abundances that have become increasingly highlighted as more orbital missions have visited the Moon. Concentrations of water at the lunar south pole was hinted at by the bistatic radar experiment conducted by the Clementine mission [9] and Earth-based radar [10]. Lunar Prospector measured significant hydrogen deposits at both lunar poles using neutron spectrometer data [11] [12] and although spatial resolution was poor, it was inferred that the hydrogen deposits were in Permanently Shadowed Regions (PSR) [13].

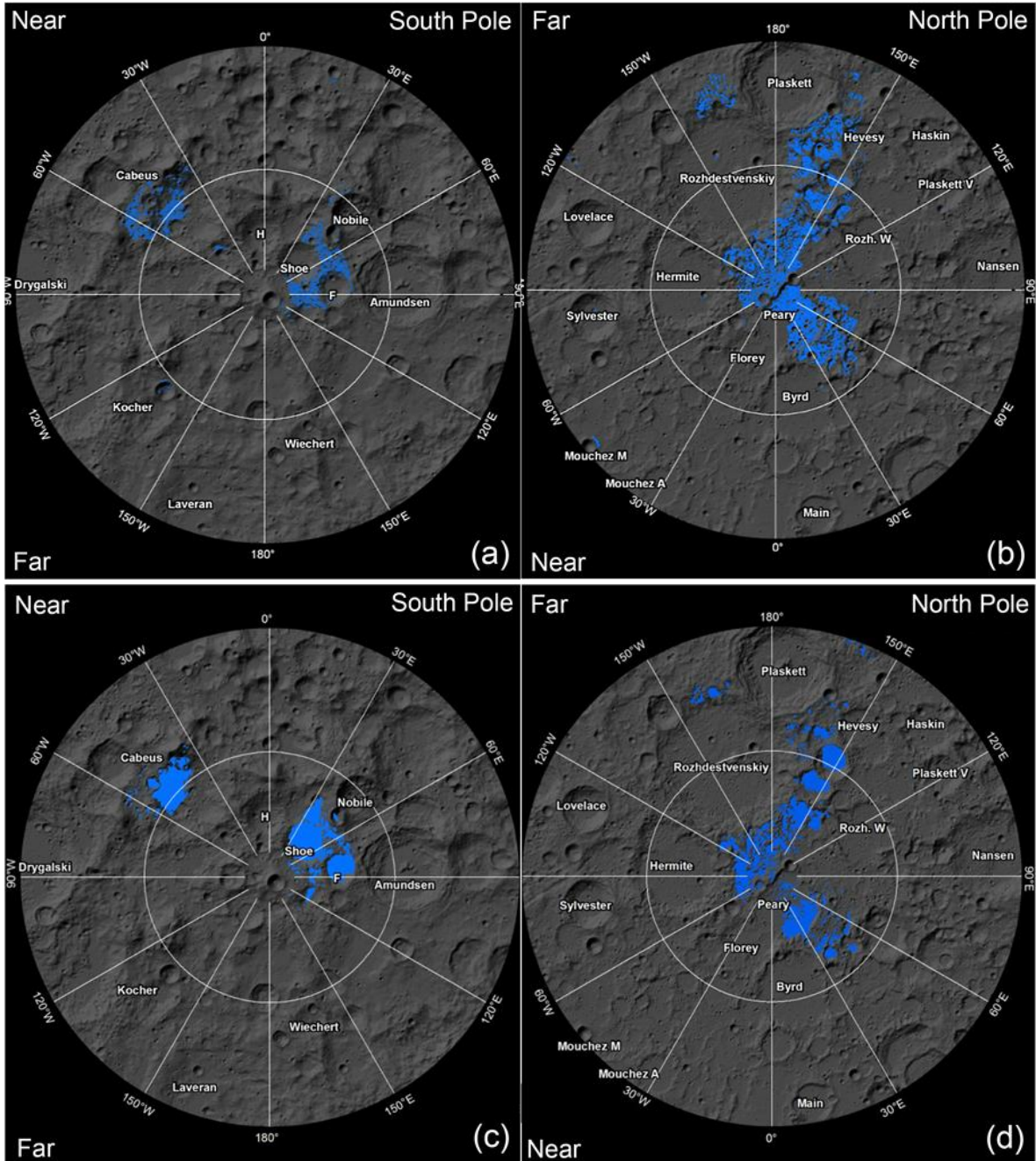
The first ground truth regarding these polar volatile deposits came from the Lunar CRater Observation and Sensing Satellite (LCROSS) mission that measured the material composition of the plume created as its companion Centaur upper stage impacted Cabeus crater, a PSR at the south pole. It was estimated that the Centaur created a crater that was 28 m (92 feet) in diameter and 5 m (16 feet) deep<sup>14</sup>. The plume of material was shown to contain  $5.6 \pm 2.9\%$  H<sub>2</sub>O by mass [14], along with NH<sub>3</sub>, H<sub>2</sub>S, SO<sub>2</sub>, C<sub>2</sub>H<sub>4</sub>, CO<sub>2</sub>, CH<sub>3</sub>OH, CH<sub>4</sub>, and OH. While LCROSS definitively showed that water ice was present in Cabeus, the mini-Radio Frequency (RF) radar data did not find evidence for water ice in this crater [15]. The interpretation is that Cabeus contains ice intimately mixed with regolith, whereas for radar to detect such deposits discrete layers or large blocks of water ice are needed [16]. However, Patterson et al. [17] reported bi-static radar data from Cabeus that was consistent with the presence of water ice at depth within the regolith. However, this detection was at a location distinct from that of the LCROSS impactor and the PSR reported by Spudis et al. [16]. Significantly, it was from the portion of the crater not in permanent shadow. The Lunar Exploration Neutron Detector (LEND) has been collecting neutron data since the beginning of the LRO mission and indicates that neutron suppression regions (equivalent to hydrogen enrichment) not only occur within PSR, but also around them [18].

The Lunar Exploration Analysis Group (LEAG) undertook a specific action team analysis to integrate multiple datasets to map out potential exploration areas for lunar volatiles [19]. This showed there are areas that could be explored for lunar volatiles without entering the PSR – a very hostile environment that would be challenging to work in. Parameters used included >150 ppm hydrogen, average temperatures of <110 K, slopes of <10 degrees (to be navigable by current rovers), and areas outside and adjacent to PSR. The intersection of these different datasets are shown in Figure 5. For the South Pole (Figure 5a), the Cabeus and Shoemaker-Nobile vicinities meet the criteria and have the advantage of some Earth visibility. For the north pole (Figure 5b), the Peary vicinity meets the criteria and have Earth visibility, but there is a substantial area on the far side that is also promising.

The one point of ground truth we have for volatiles within a PSR is the LCROSS impact site into the PSR of Cabeus crater. The parameters of the Cabeus PSR are documented by the LRO instruments and have been compared to other PSR in the south (Figure 5c) and north (Figure 5d) poles. For the South Pole, the remainder of Cabeus crater and the Nobile-Shoemaker craters are locations similar to the LCROSS site in H abundance and temperature (Figure 5c). For the North Pole, Peary and the north rim of Hermite are most similar to the LCROSS site and have Earth visibility. There are several regions on the far side that extend from the North Pole towards the crater Hevesy that also show similarities to the LCROSS impact site (Figure 5d).

---

<sup>14</sup> [https://www.nasa.gov/mission\\_pages/LCROSS/searchforwater/LCROSS\\_impact.html](https://www.nasa.gov/mission_pages/LCROSS/searchforwater/LCROSS_impact.html)

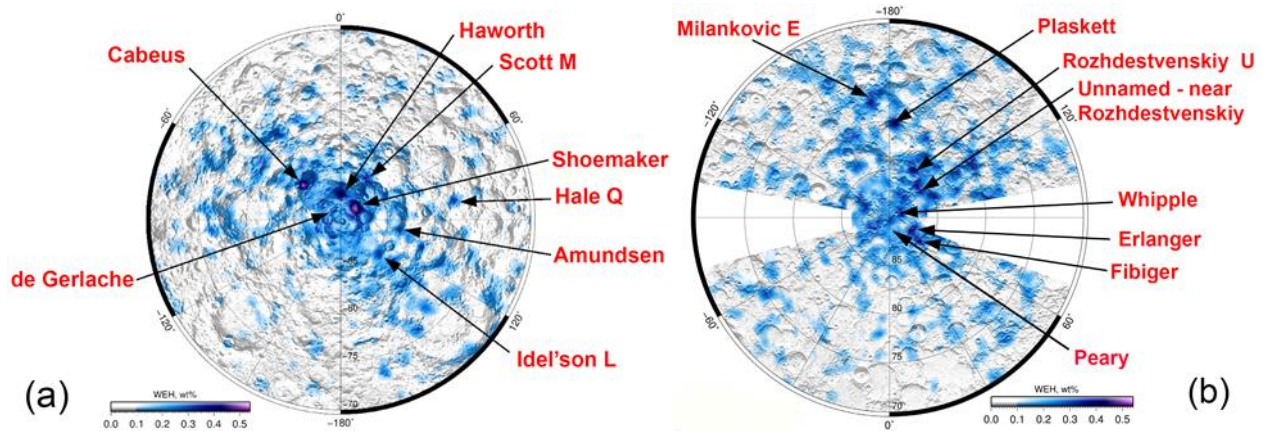


**Figure 5: Representation of the South [(a) and (c)] and North [(b) and (d)] Poles of the Moon**

*The intersection of the following criteria are represented in (a) and (b):  $>150$  ppm hydrogen,  $<110$  K average temperature,  $<10$  degree slopes, and areas outside and adjacent to PSR. In (c) and (d), the blue highlighted areas represent those areas that are like Cabeus as defined by the LCROSS mission [14] [20]. The definition of “likeness” is explained in LEAG [19].*

Quantitative estimates of water ice in and around PSR have been published using data from LRO. The Lunar Orbiter Laser Altimeter (LOLA) used an infrared spectrometer (IR @ 1064 nm) to measure topography and slopes, but enhanced reflections were observed in several PSR at both poles, with Shackleton crater at the south pole giving the highest reflection [21] [22]. Models suggest 3-14% water ice by mass would be needed to give such reflectance observed in the PSR. The Lyman Alpha Mapping Project

(LAMP) ultraviolet spectrometer (110-190 nm) also detected a strong change in spectral behavior at locations with maximum surface temperatures <110 K consistent with cold-trapped surface ice [23] [24]. The results showed that the regolith in most PSR have much larger porosities than non-PSR regions, but the enhanced albedo was heterogeneously distributed and not observed in all PSR. Modeling indicates the enhanced albedo can be achieved by layers of >100 nm, or 1-2% of water frost at the surface. The LEND neutron data have also been used to estimate amounts of water-equivalent hydrogen (WEH) in and around PSR (Figure 6). The richest deposits are within PSR at the South Pole (up to 0.55 wt.% WEH), but this could be due to the fact that the LRO orbit has consistently had a lower altitude over the south pole than the north for much of the mission. The data from the North Pole may have been diluted due to a larger footprint for the data.

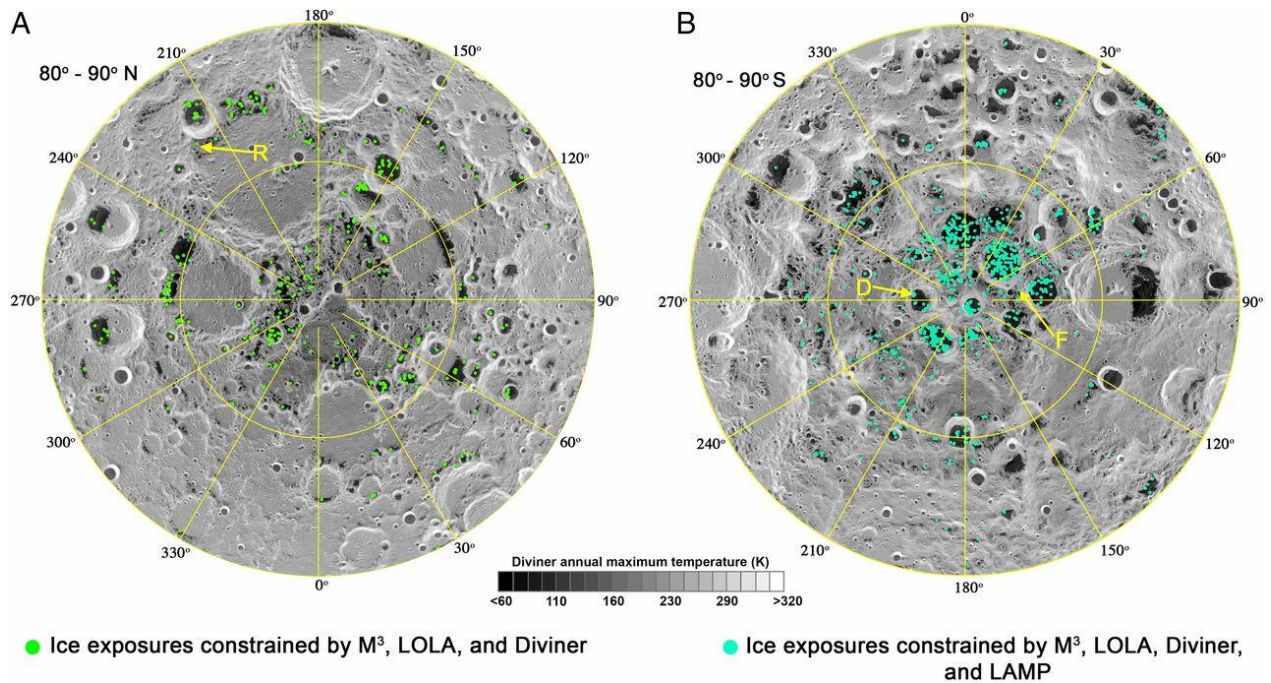


**Figure 6: WEH Estimates from the LRO-LEND Neutron Data<sup>15</sup>**  
*Shown in and around PSR at the (a) lunar South Pole, and (b) lunar North Pole.*

Recently, the M<sup>3</sup> data has been used to examine PSRs and have detected water ice at the surface of some of them [25]<sup>16</sup>. Most ice locations thus detected also exhibit LOLA reflectance and LAMP UV ratio values consistent with the presence of water ice at the surface, coupled with annual maximum temperatures below 110 K (Figure 7) [25]. However, only ~3.5% of Cold Traps (CT)s exhibit ice exposures, probably due to lunar polar wander [26] and impact gardening. In terms of ISRU potential, spectral modeling shows that some ice-bearing pixels may contain ~30wt% ice that is intimately mixed with dry regolith.

<sup>15</sup> Adapted from Sanin et al. [166]

<sup>16</sup> [www.pnas.org/cgi/doi/10.1073/pnas.1802345115](http://www.pnas.org/cgi/doi/10.1073/pnas.1802345115)



**Figure 7: Presence of Surface Water Ice in PSRs at the North and South Polar Regions of the Moon**  
*Data points show the coincidence of positive results for surface water ice using M<sup>3</sup> and LOLA data for the North Pole, and M<sup>3</sup>, LOLA, and LAMP data for the South Pole. Data points also have maximum annual temperatures of <110 K from Diviner data. Adapted from Li et al. [25].*

Based on the data gathered by missions in the last 25 years, we have well defined targets to get to the lunar surface and start prospecting for water ice and other volatiles on the surface of the Moon. Although PSR may contain highly concentrated water deposits, they are extremely inhospitable and will be challenging for preliminary prospecting missions. Exploration outside of the PSR is also critical to understanding the H-rich deposits that extend beyond them including the pyroclastic deposits that show promise as volatile resources. The major next step is to undertake geologic prospecting in promising regions to determine the distribution, form, composition, abundance, and extent of the deposits, as well as the geomechanical properties of the deposits. Such extensive ground truth data are needed to close business cases; understand the origin and evolution of such deposits; and to allow the lunar economy to be further developed.

### Exploring in Permanent Darkness<sup>17</sup>

Eventually, however, exploration within the Permanently Shadowed Regions (PSR) must be undertaken with all the technical challenges that it would bring. It is critical that we survey and prospect “appropriate ground” – we cannot do extensive wide area surveys on the ground. Thus, the question is, “What constitutes such ground?”

As a start, consider the following criteria:

1. Locate areas of permanent darkness (PD) within PSRs for highest concentrations of volatiles.
2. Locate water ice deposits within 10 km of a Permanently Lit Area (PLA) so that power transmission from sunlit locations is possible (nuclear power option may mitigate this criteria)
3. Remote data indicates general presence of H<sub>2</sub>/water enrichment at location.
4. Accessible terrain and slopes for whatever mobility solution is chosen.

<sup>17</sup> Section Author: Paul Spudis (deceased), Lunar and Planetary Institute, Senior Staff Scientist

These are not too stringent and offer several possible sites to focus on. We have no real preference for which pole we choose, but in general, the North Pole has many smaller PSRs that are within 10 km of a PLA (Figure 8). The North Pole is on the northern rim of Peary crater, indicating substantial real estate with PLAs; though, the craters containing ice are substantially far away from this location. The small craters on the southern floor of Peary, in Hermite A, and in the rough terrain to the south and west of Hinshelwood however, do contain ice and are within proximity to PLAs. The south offers larger PSRs (and more water), but terrain is very rugged, with up to 40° slopes (!). None of these sites is in Earth Line of Site (LOS) view for communications. RF and/or laser communications relay will be needed, either on surface or (more probably) in orbit.

How do we get this information? After due consideration, the best way is to slog it out overland, with a long-lived, capable rover that can explore multiple dark areas. Challenging. A lower cost solution might be to build multiple, small, hard-landing probes, but you will probably only get hints at what's really there (e.g., a neutron spectrometer is very small and could work on a hard lander, but only senses bulk H<sub>2</sub>, and then, only the upper meter of the surface.)

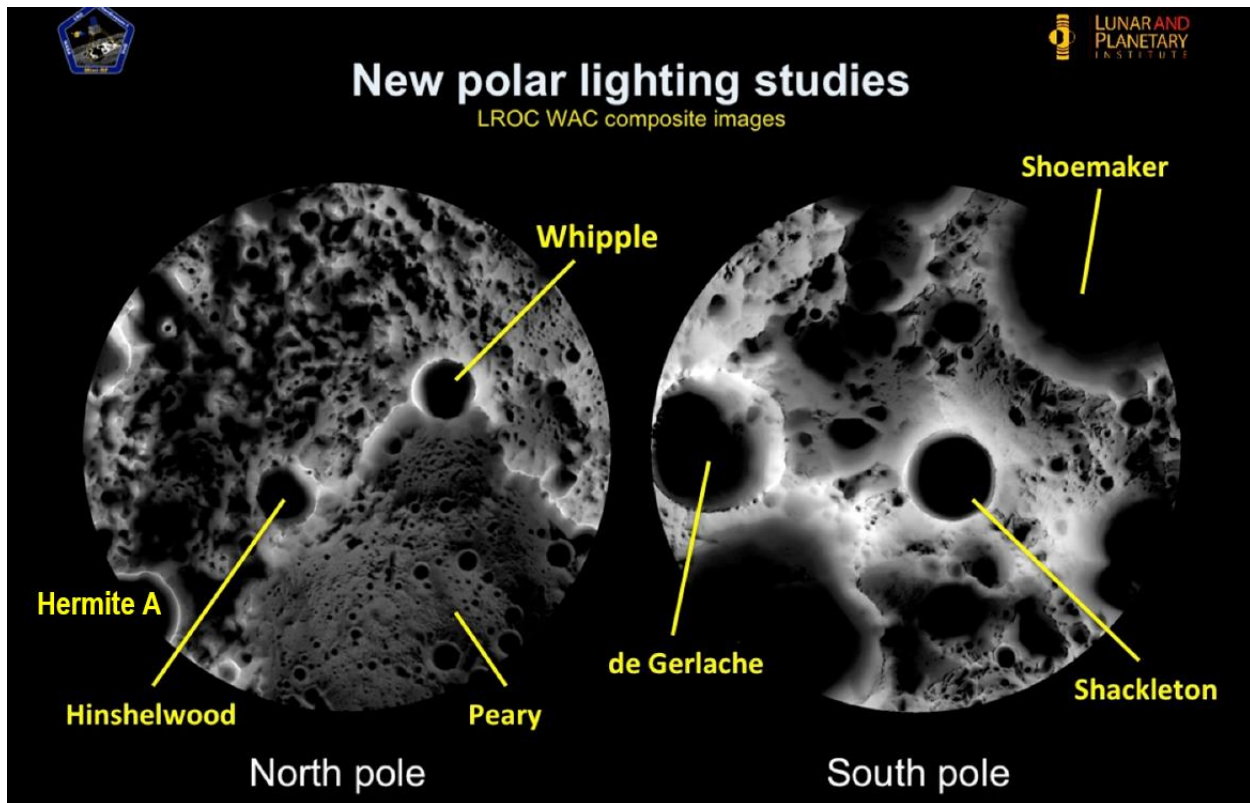
You need a soft-lander. Anything that can deliver between 500-1000 kg to the surface can be made to work. The rover needs power, including lighting for work within PD. A rechargeable battery with a Radioisotope Thermoelectric Generator (RTG) is one possible solution to this challenge. If not possible under budget restrictions, rechargeable fuel cells/batteries could also be considered. A hydrogen/oxygen lander using residual propellants in a fuel cell or ULA's Integrated Vehicle Fluids (IVF) Auxiliary Power Unit (APU) is a non-nuclear alternative that would offer days or weeks for a rechargeable crater rover.

I would consider a prospect complete if it were able to investigate and characterize all PSRs within the 10 km circle. Water is heterogeneously distributed on the Moon – some large areas seem to have none, while some small ones have excess. Water deposition appears to be a non-equilibrium, stochastic process.

Strawman prospecting rover instrument package:

- Drill or mole (obtain subsurface samples) such as the Trident system described in the next section
- Sample handler and packaging for analysis (prepare samples for analysis)
- Gas chromatograph/mass spectrometer (complete major, minor, trace elements)
- Oven (bake soil and watch evolved gas release)
- Neutron spectrometer (bulk H<sub>2</sub> over traverse and in prospects)
- Imaging Light Detection and Radar (LIDAR) (make detailed topo maps of good prospects; navigation)
- Multi-spectral imager with artificial illumination (map 3 micron water band)





**Figure 8: Lunar Polar Lighting Studies**

*Terrain within 2° of latitude (60 km) of the lunar north and south poles. Black areas are PDs; white areas receive sunlight for >50% of lunar day (PLAs).*

Top crater PSR candidates for exploration:

North Pole prime candidates: Hermite A, the region to the south and west of Hinshelwood, and the small (~5-10 km diameter) craters on the southern floor of Peary. Prime power site – rim of Hermite A, Peary, Hinshelwood, and Whipple.

South Pole prime candidates: Shackleton, de Gerlache, small-unnamed PSRs around Shackleton. Prime power site: rim of Shackleton (about 9:00 o'clock position)

### Methodology<sup>18</sup>

The most basic element needed for a new endeavor is information. This is especially true where large investments hinge on undertakings that carry elevated levels of difficulty and extended timeframes. In order to determine an effective location for resource extraction or outpost placement on the Moon, information about the regolith composition and terrain of potential sites will have to be known beforehand. The purpose of a prospector mission is to build upon previous knowledge gained and provide critical data about key characteristics of the lunar surface. Early Prospector missions are not only essential for gathering data for scientific purposes, but also for maximizing the effectiveness of subsequent missions.

Composition of the lunar regolith can vary widely between regions and will dictate the products that are most appropriate for extraction in that location. To know the composition at a desired location, prospecting missions will consist of a rover-like vehicle with a specially tailored payload, similar to that of

<sup>18</sup> Section Author: Justin Cyrus, Lunar Outpost, CEO

the National Aeronautics and Space Administration's (NASA)'s cancelled Resource Prospector (RP). A trowel or scooping mechanism should be employed to gather surface samples, but more likely, a core drill will be used for excavating and collecting subsurface samples, giving a better indication of local resources. An onboard oven will heat up the collected samples in order to release volatiles, which then are characterized by a neutron spectrometer or an infrared spectrometer. All this instrumentation will sit upon a rover body capable of traversing the surface and imaging its surroundings. Images and location will be overlaid with regolith analysis to provide a resource map for the area of interest.

Another prospecting architecture will employ a satellite mission orbiting the Moon, like NASA's recent LCROSS and LRO that remotely senses regolith composition. This vehicle will cover more area, but will not be able to gather as detailed information as the rover will. In order to get a better understanding of a location, a method that was used in LCROSS was to use an impactor to strike the surface, creating a cloud of material for a satellite to analyze.

Prospecting missions will have several different architectural schemes that depend upon the number of vehicles used. At one end of the spectrum, a single, highly capable vehicle with a longer lifetime will be deployed. At the other end, a swarm of smaller units will be used to collect samples. These would most likely not be able to dig as deep or have the lifespan of a larger version, but will be able to gather more information quickly and decrease risk by providing redundancy. Ultimately, it will depend on the mission goal and the associated economics; however, a hybrid approach will be a good compromise that better supports subsequent mining operations.

A suggested prospecting architecture will begin with remote sensing to gain a general understanding in areas not previously mapped by LCROSS or LRO. The next step will be to deploy a swarm of cheaper prospecting autonomous robotics to gain detailed information on a large area of the lunar surface. The last step in this suggested architecture will then be to use a single or pair of more capable prospectors to gather detailed resource information at the most promising sites.

### **Surface and Subsurface Sampling<sup>19</sup>**

For approximately two decades, Honeybee Robotics<sup>20</sup> has been developing one-meter-class drills for the acquisition of volatile-rich samples from planetary surfaces. The latest drill system, referred to as TRIDENT (The Regolith Drill for Exploration of New Terrains) [27], is a 16-kg rotary-percussive drill and deployment system that was designed to be deployed from a roving platform to support missions requiring acquisition of samples from up to a depth of 2 m (the design is scalable to length). It is capable of drilling into ice-cemented regolith and rock at high rates of penetration (> 1 m/hour) with very modest requirements for power (100-200 W) and weight on bit (< 100 N). The system is shown in Figure 9.

---

<sup>19</sup> Section Authors: Jared Atkinson, Honeybee Robotics, Senior Geophysical Engineer; Philip Metzger, University of Central Florida, Planetary Scientist; Phillip Morrison, Honeybee Robotics, Systems Engineer; and Kris Zacny, Honeybee Robotics, VP & Director of Exploration Technology

<sup>20</sup> <https://www.honeybeerobotics.com/>



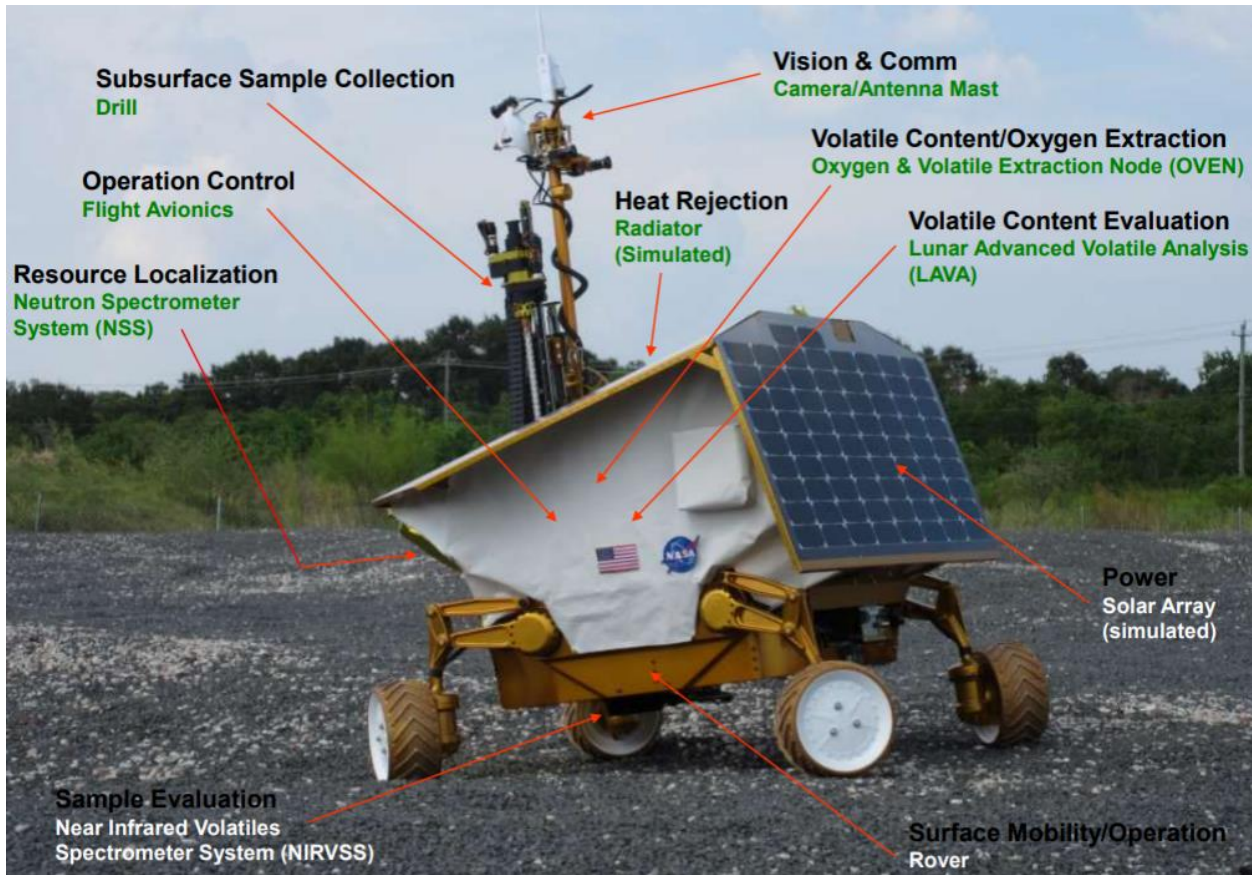
**Figure 9: TRIDENT Drill and Deployment System**

*CAD model of TRIDENT drill and deployment system (Left); photograph of TRIDENT drill and deployment system mounted to a support structure.*

To support the Lunar RP mission, TRIDENT was qualified to operate in the South Pole's Aitken Basin, where it would experience hard vacuum, radiation, reduced gravity, and cryogenic temperatures down to 40 K. Lunar RP's purpose was to ground truth the presence of water within a PSR of the Moon. A photograph of the RP15 rover under development for the mission is shown in Figure 10. It includes a suite of instruments designed to identify and analyze volatile content within lunar regolith. Operational concepts for sampling within the mission were as follows [28]:

1. The Neutron Spectrometer Subsystem (NSS) monitors the lunar surface for high concentrations of hydrogen that would indicate a high likelihood of water present in the regolith. When a hydrogen-rich site is located, the rover parks above the site and deploys TRIDENT.

2. TRIDENT drills 10 cm into the regolith and then retracts, emptying cuttings onto the lunar surface or into a sample container, as instructed. TRIDENT continues to take 10-cm “bites” until it has reached its maximum depth of 1 m. During this time, TRIDENT monitors its bit temperature using an embedded Resistance Temperature Detector (RTD) to provide information about the regolith thermal profile and to verify that the bit remains sufficiently cold to prevent volatile loss from the sample.
3. The samples deposited onto the ground during drilling are first analyzed by the Near InfraRed Volatiles Spectrometer Subsystem (NIRVSS). NIRVSS characterizes the hydrocarbons, mineralogical context for the site, and the nature of any water ice present to determine whether a given sample is appropriate for further analysis.



**Figure 10: Lunar Resource Prospector RP15**

*Photograph of RP15 rover for Lunar Resource Prospector mission [29] with annotations for NSS, NIRVSS, OVEN, LAVA systems for volatile recognition; drill shown is an earlier version of TRIDENT.*

If the sample is expected to be of high scientific value, TRIDENT places it into the Oxygen and Volatile Extraction Node (OVEN). The OVEN heats up the captured sample and transfers evolved volatiles into the Lunar Advanced Volatiles Analysis (LAVA) subsystem which quantifies and characterizes volatile species. The OVEN can also be used to demonstrate hydrogen reduction, while LAVA can perform a Water Droplet Demonstration (WDD).



## **Mining Operations**

## Active Extraction<sup>21</sup>

While observations from LCROSS and LRO have confirmed the presence of water within Permanently Shadowed Regions (PSR) of the Moon [14] [30], there is uncertainty regarding the possible physical forms of lunar H<sub>2</sub>O, which could include blocky ice deposits [16], adsorbed molecules, or hydrated minerals. The distribution of water is also thought to be heterogeneous both laterally and with depth, potentially including a desiccated layer of several 10s of cm [31]. For these reasons, early water extraction systems should be capable of harvesting both near surface and subsurface water in its potential forms. Ideally, these systems would also be able to identify the presence of water in near-real time to allow extraction energy to be directed most efficiently.

### Rover Mounted Drills

As discussed in the Surface and Subsurface Sampling section, Honeybee Robotics has explored several on-site water-extraction concepts that utilize a rover-mounted rotary-percussive drill. These systems drill into H<sub>2</sub>O-bearing regolith, heating it directly within the borehole or just above the surface to sublimate ice or release bound water. The water vapor then flows passively into a condenser, depositing as ice to maintain a pressure gradient through the system. This approach has a number of clear advantages over competing water-extraction concepts:

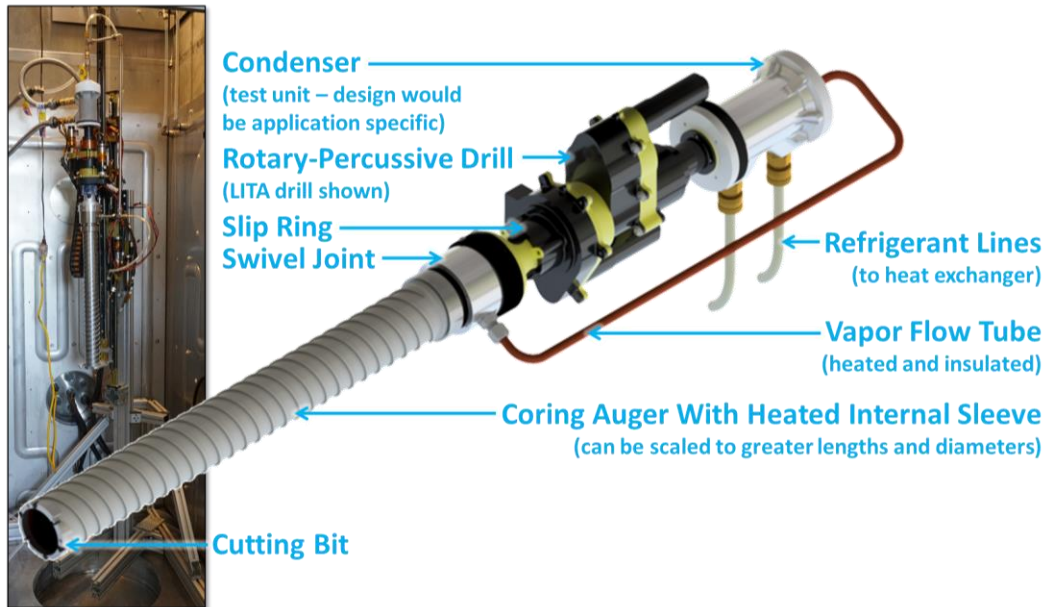
- It is capable of extracting water at a range of depths and locations in various forms, including coherent ice, ice-cemented regolith, surface frost, and hydrated minerals. It can also infer the presence of water at a drill site by, for example, monitoring the heating response of the regolith, which shows a clear suppression of temperature increase during sublimation. This allows the system to identify and harvest the richest deposits of H<sub>2</sub>O.
- By capturing water locally, it avoids the need to transport feedstock for off-site extraction, preserving energy and preventing sublimation of ice from recently exposed regolith in route.
- It can be designed to utilize electric or thermal energy to sublimate water, and to reject heat from the condenser either passively or actively. Through proper selection of materials and geometry (primarily auger length and diameter), the system can also be optimized based on the expected thermal conductivity and gas permeability of the water-bearing regolith.
- It allows for tighter control over volatile temperature and flow, helping to ensure that water vapor is efficiently collected and does not escape the system or deposit on unintended surfaces. By applying heat directly to the subsurface, this approach also makes it possible for freed water vapor from the bottom of the borehole to heat regolith convectively on its way up. This significantly reduces the time and energy required for heat to reach the center of the core.

Two rover-mounted drill-based water-extraction systems referred to as PVEx (Planetary Volatiles Extractor) and MISWE (Mobile In-Situ Water Extractor) are described in Zacny et al. [32] [33] and Vendiola et al. [34], shown in Figure 11 and Figure 12 respectively. Both apply heat to water-bearing regolith and flow extracted water vapor to a low-temperature condenser (CT) for deposition. The primary difference between the approaches is that PVEx uses a coring auger to drill and heat the regolith within the borehole while MISWE utilizes a deep-fluted closed auger to bring cuttings to the surface for heating within a closed, sealed vessel. In these and similar concepts, the total energy required for extraction is driven by

---

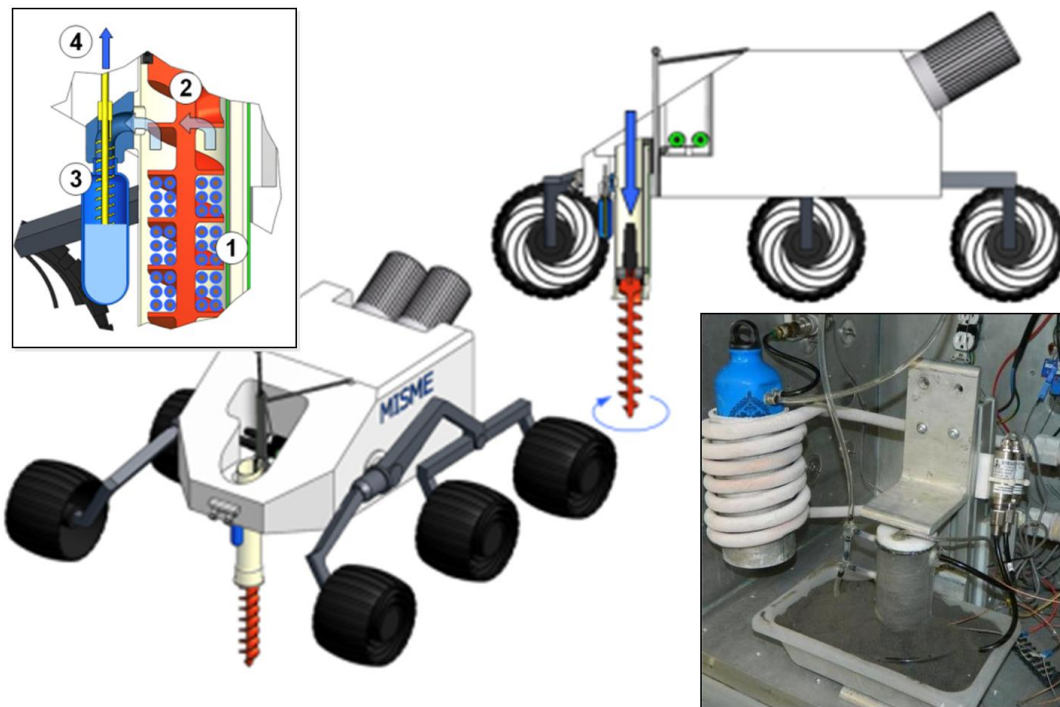
<sup>21</sup> Section Authors: Jared Atkinson, Honeybee Robotics, Senior Geophysical Engineer; Philip Metzger, University of Central Florida, Planetary Scientist; Phillip Morrison, Honeybee Robotics, Systems Engineer; and Kris Zacny, Honeybee Robotics, VP & Director of Exploration Technology

the latent heat of sublimation for water rather than sensible heat exchange with the hardware or regolith, overcoming heat loss or other inefficiencies, or drilling energy.



**Figure 11: PVEx System Mounted to LITA**

(Main) Annotated CAD rendering of PVEx system mounted to LITA drill; (Inset) photograph of PVEx system on mounting base prior to undergoing end-to-end vacuum chamber testing.



**Figure 12: MISWE Rover with Drill**

(Main) MISWE rover with drill extended; (Top Left) schematic diagram of water flow in vapor and liquid form through system; (Bottom Right) photograph of vacuum chamber proof-of-concept test.

Breadboard versions of both PVEx and MISWE have been built and shown to extract up to 80% of the water present in a sample of simulant under vacuum conditions [35]. A TRL 4/5 version of PVEx has also been built and integrated with an existing Honeybee LITA (Life in the Atacama) drill [36], demonstrating the end-to-end water-extraction process on water-bearing regolith simulant. Honeybee will soon test an updated version of this system designed to interface with the TRL6 TRIDENT drill [37] described in the Surface and Subsurface Sampling section above.

Lower-TRL variations of the PVEx concept have also been explored. These include:

- The use of a Mechanically Pumped Fluid Loop (MPFL) and external heat exchanger to circulate heated fluid through internal flow passages of a coring auger. This provides a method by which to leverage excess heat energy generated by a Multi-Mission Radioisotope Thermoelectric Generator (MMRTG) or similar for sublimation of water.
- The use of high-temperature gas pumped radially inward from the coring auger to heat the regolith core convectively, overcoming the extremely poor thermal conductivity of lunar regolith in vacuum. It has been suggested that excess O<sub>2</sub> or sublimation byproducts could be used as renewable process gas for this purpose.
- The use of a polished, nickel-plated composite auger and an oversized borehole to minimize the conductive and radiative heat loss from the internal heated sleeve of the auger to the surrounding regolith. Concepts have also been discussed to seal off the lower end of the auger during heating to prevent heat loss through the bottom of the core more effectively.
- The full-faced auger mechanically conveys cuttings out of the borehole and through a microwave heating system above the surface. Desiccated cuttings would then be left behind as the system moved to the next drill site.

### **Subsurface Heating**

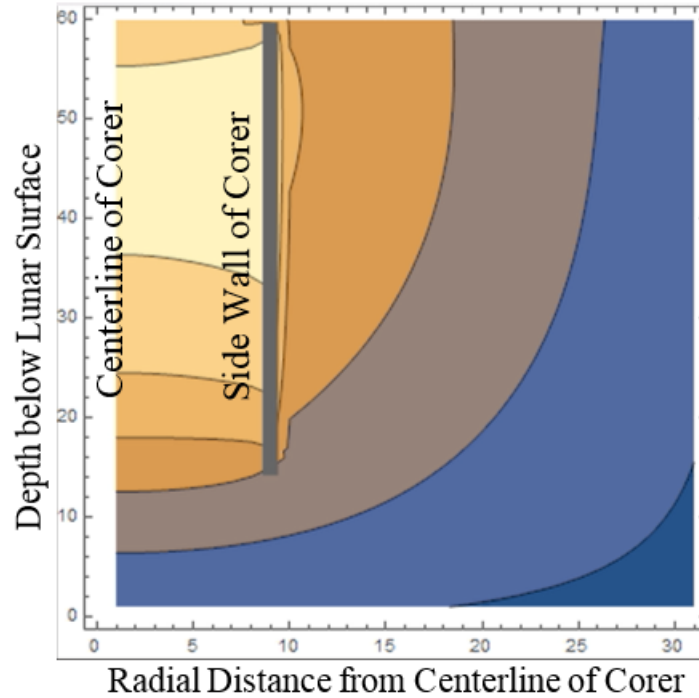
By directly heating subsurface regolith in situ and maintaining tight control over vapor temperature and flow, PVEx is likely to be more energy efficient than competing concepts. The design can also be scaled to collect much greater quantities of water when paired with large rover systems. In one scenario, a number of small-to-medium-sized PVEx systems could be used as part of a lunar-propellant pilot program, establishing ground truth for the presence of H<sub>2</sub>O within a target PSR, obtaining initial water supplies for operation, and identifying optimal sites for further extraction. Large PVEx systems could then be deployed to achieve the desired full-scale production rates.

Such water-extraction techniques used by Honeybee Robotics are being modeled (Figure 13) and validated by Phil Metzger at the University of Central Florida (UCF)<sup>22</sup> using a high-fidelity code that extends the capabilities of existing heat transfer [38] [39] [40] and gas diffusion [41] codes and simulations. Using novel techniques to incorporate the contributions of variable regolith density and thermal conduction, physical ice form, and phase change (sublimation), vapor production and mobility can be predicted, leading to estimates of efficiency, extraction energy quantification, and effectiveness of the extraction design geometry. Results so far indicate that reasonable energy and temperatures are all that is required to extract water at economically viable yields.

---

<sup>22</sup> <https://planets.ucf.edu/>





**Figure 13: Lunar Regolith Subsurface Heating Profile**

*2D Axisymmetric simulation of heating lunar soil inside a corer that has penetrated into the lunar surface. Lighter color (yellow) indicates higher temperature, while darker (blue) indicates colder. The model predicts energy usage to extract volatiles thermally.*

### Passive Extraction<sup>23</sup>

Methods for extraction of Permanently Shadowed Regions (PSR) ice can be grouped into two classes: extraction based on bulk physical removal of icy regolith as solid material from the ground and extraction based on in situ sublimation of ice that allows regolith to remain in place. Excavation-based methods are typified by bulk excavation of the surface using rovers equipped with shovels, bucket ladders, or bucket wheels. Excavation methods require transport and handling of large volumes of regolith, which drives up mass and power requirements of PSR ice collection. Extraction methods based on sublimation of ice directly from the surface using directed energy methods, such as sunlight, microwaves, or radiant heaters avoid many of the drawbacks of excavation methods. Sublimation of ice in the ground is followed by vapor transport to a collector that hauls only the ice to a processor.

Thermal mining is a mining method that exploits in situ sublimation of ice that is efficient, scalable, and sustainable method of ice mining at the lunar poles. With lower weight and fewer moving parts, as compared to excavation methods, thermal mining provides a feasible alternative to excavation concepts.

### Thermal Mining

The Colorado School of Mines (CSM)<sup>24</sup> has developed a system architecture for PSR mining operation to extract and process water ice into Liquid Oxygen (LOX) and LH2 propellant [42], as shown in Figure 14. In thermal mining heat is applied either directly on the surface via concentrated sunlight or heating elements, subsurface via conducting rods or heaters placed in boreholes, or both depending on the local conditions (heating elements can be powered either by solar or nuclear options as described further in the

<sup>23</sup> Section Authors: Angel Abbud-Madrid, Colorado School of Mines, Professor of Space Resources; and Chris Dreyer, Colorado School of Mines, Professor of Space Resources

<sup>24</sup> <https://space.mines.edu/>

Power section). A schematic of the concept is shown in Figure 15. The heat sublimates ice into vapor, which escapes from the surface. Vapor is captured by a dome-shaped tent covering the heated surface. Vapor in the tent is vented through openings into Cold Traps (CT)s outside the tent where it refreezes. Once the CTs are full of refrozen ice, they are removed and replaced with empty CTs. The ice-filled CTs are transported to a central processing plant for refinement into purified water, oxygen, or Liquid Oxygen (LO2) and LH2 propellants. The entire operation can be tele-operated from Earth. Critical functional steps of thermal mining are:

1. Sublimation of ice and transport of water vapor through the subsurface
2. Equalization of the vapor production rate to sum of CT and vapor loss rates
3. Reduction of vapor loss rate to a low level
4. Power delivery and passive cooling of the CTs

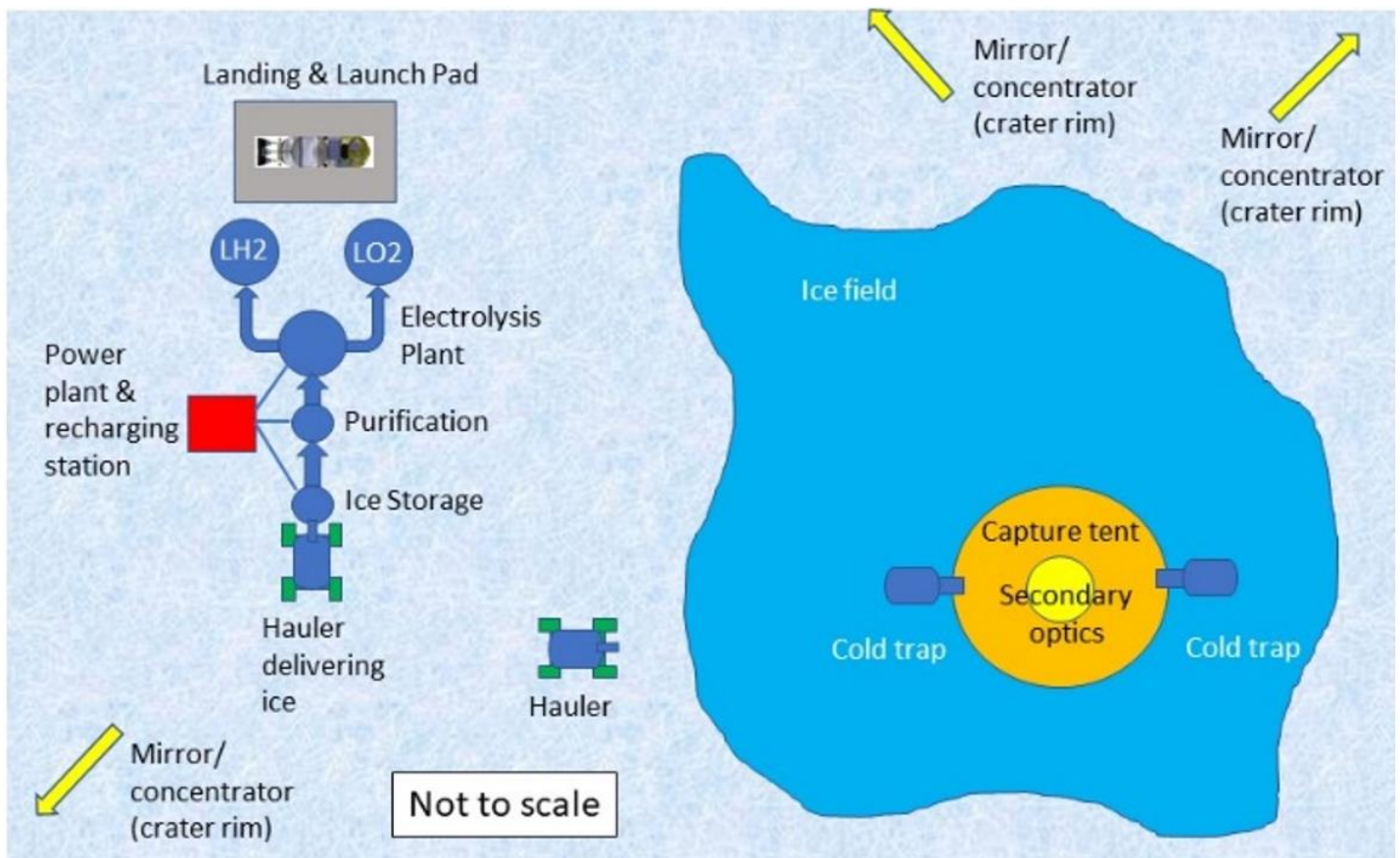
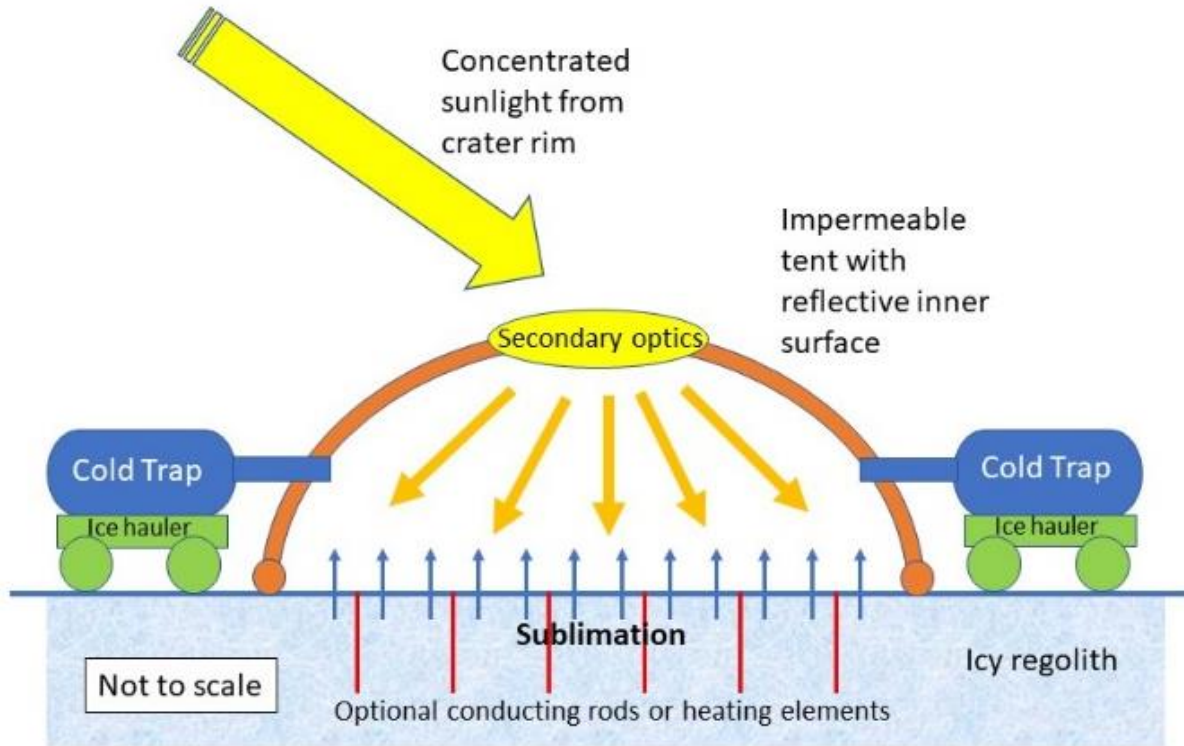


Figure 14: System Architecture (Plan View)



**Figure 15: Thermal Mining Concept**

### **Sublimation and Vapor Transport**

In thermal mining, the surface of the PSR is heated to sublimate ice and transport vapor through the surface. The goal is to cause a sufficient rate of water vapor transport out of the surface to meet overall system production rates. The process is governed by heat transfer through the surface, vapor generation via sublimation, and vapor transport through the surface. An adequate rate of vapor transport out of the PSR surface can be generated due to several factors:

1. The heat transfer rate of icy regolith is significantly greater than dry regolith
2. Sublimation of water increases to high rates above 200K
3. LCROSS mission data suggest the surfaces in the PSR are porous, thus vapor can diffuse through the subsurface

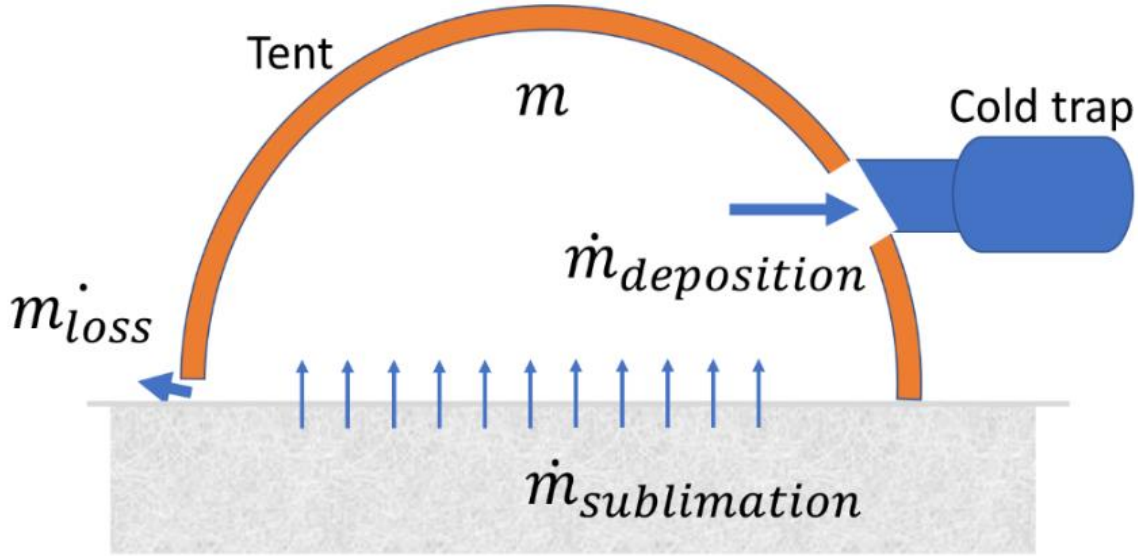
### **Balancing the rates**

Figure 16 shows a schematic of the Thermal Mining ice extraction process that focuses on the movement of gas through the tent and CT. The process can be described by a differential equation:

$$\frac{dm}{dt} = \dot{m}_{sublimation} - \dot{m}_{deposition} - \dot{m}_{loss}$$

Above,  $m$  is the mass of water vapor in the tent at any time.  $\dot{m}_{sublimation}$  is the mass flow rate of water vapor emerging from the PSR surface via sublimation,  $\dot{m}_{deposition}$  is the mass flow rate at which water is frozen in the CT, and  $\dot{m}_{loss}$  is the rate water vapor is lost through leaks in the tent, which is primarily due to the imperfect gap between the tent and the PSR surface. We assume that  $\dot{m}_{loss}$  can be kept to <10% of  $\dot{m}_{sublimation}$ , which requires that the surface area of the tent-to-surface gap be <10% of the CT entrance

area. In this analysis, we assume the CT has sufficient internal surface area to capture ice and sufficient heat dissipation via radiation to the environment to freeze ice at  $\dot{m}_{deposition}$ .



**Figure 16: Thermal Mining Ice Extraction Process**

Freezing ice within the CT is an effusion process represented by:

$$\dot{m}_{deposition} = pA_{coldtrap} \sqrt{\frac{M_{H_2O}}{2\pi RT}}$$

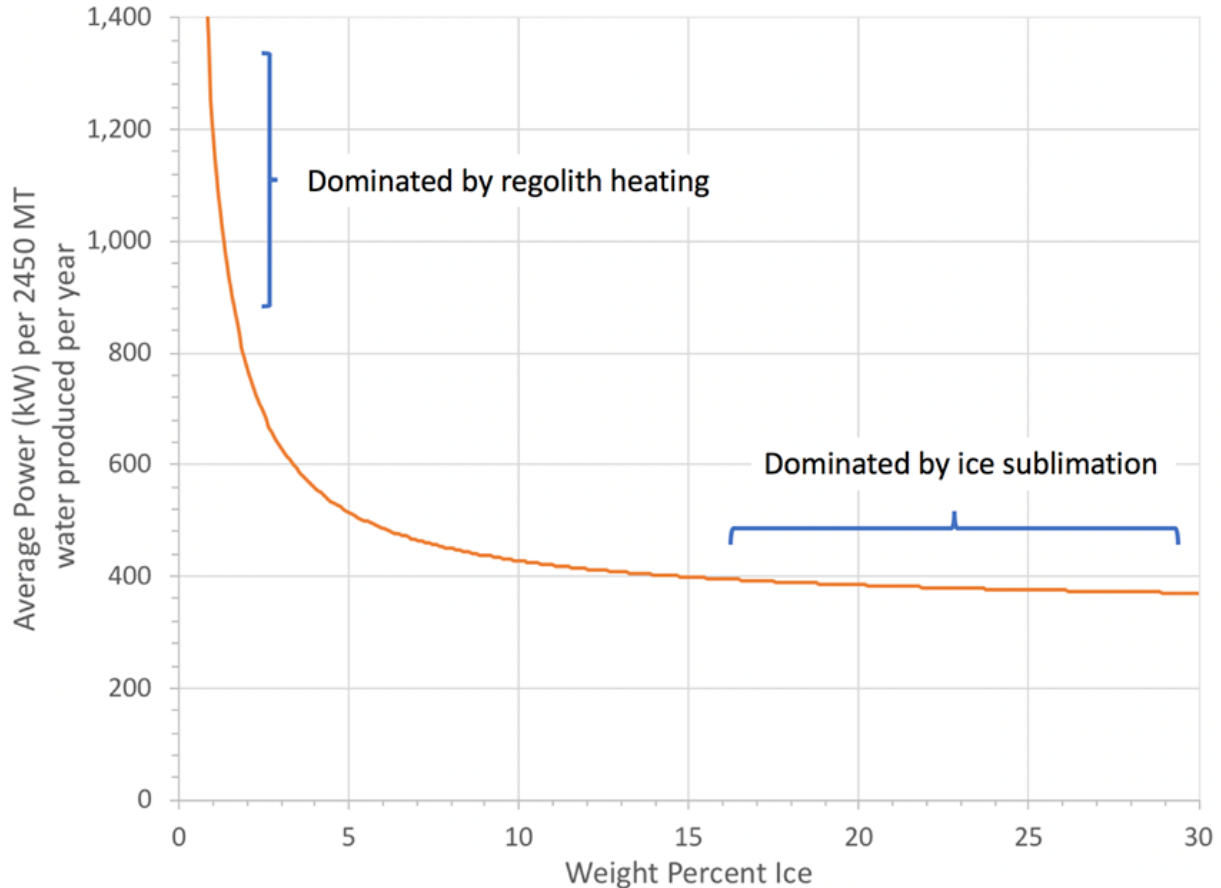
Where  $p$  is the pressure in the tent,  $A_{coldtrap}$  is the entrance area of the CT, and  $T$  is the temperature of a water molecule. A similar effusion equation can be written for  $\dot{m}_{loss}$  by replacing the CT entrance area with the area of the gap between the tent and PSR surface. Using the ideal gas law, the mass of water vapor under the tent,  $m$ , can be written in terms of the pressure, volume, and temperature of gas under tent. The differential equation then becomes a first order Ordinary Differential Equation (ODE) for pressure as a function of time.

The surface must be heated to a temperature such that sublimation proceeds at a rate sufficient to meet production goals. Kossacki [43] show that the sublimation rate increases rapidly above 200 K and Andreas [44] shows that 100  $\mu\text{m}$  diameter ice grains lose mass rapidly above 170 K. Surface temperature for sublimation was set at 220 K. The inner surfaces of the tent walls must also be maintained above 220 K, or the sublimated water vapor will re-freeze there rather than in the cold trap. At this temperature, the system quickly goes to steady state in minutes, and the tent pressure will equilibrate at 10 to 30 Pa for a CT entrance area of 1  $\text{m}^2$ . Quick approach to steady state means that the tent transfer dynamics will essentially be in steady state throughout operation and the transients in the overall system are governed by heat transfer, sublimation, and vapor transport through the surface. Low operating pressure is important for several reasons:

1. If the pressure rises too high the tent can lift off the surface
2. The mean free path is less than the characteristic dimensions of the system ( $<1$  m), which ensures that the analysis and modeling methods are in the correct flow regime

### Sublimation Power Requirements

Critical components of thermal mining are power delivery for sublimation of ice from the PSR surface and power to freeze the vapor into the CTs. Figure 17 shows the power needed to extract ice by sublimation from the PSR. Power is sensitive to ice content below 2wt% ice because it is dominated by the power needed to heat regolith; whereas, above 5wt% the power becomes relatively insensitive to ice content. Extracting the ice is a two-step process: heating the icy regolith mixture from 40 K to 220 K followed by sublimation.



**Figure 17: Power to Sublimate by Concentration**

*Power to extract 2,450 MT of water ice per year with 70% solar availability as a function of water weight percent.*

The best estimate of lunar PSR water ice content comes from the LCROSS mission at 5.5wt% ice, while other estimates put the ice content at 10wt% and the most pessimistic estimates put it at 1wt%. This suggests that the thermal mining process should be situated at a location with more than 4wt% ice. Recent re-analysis of mission data found areas with >30% ice [25]. At 30% ice, the power needed to sublimate icy regolith material is 33% less than the power needed at 4% ice and is only 10% greater than the power needed to sublimate pure ice.

Thermal mining employs a CT that is passively cooled by radiation to the ambient PSR environment. The surface of the PSR are as low as 40K, while space is 2.7K. The CT must provide sufficient cooling capacity to dissipate the heat of deposition (equal to the heat of sublimation). This can be provided by the thermal mass of the CT and sufficient radiative surface area on the CT. The CT temperature will drop to near the ambient environment during transport between the tent(s) and gas processing system. Ice

collection in the CT will proceed until the CT surface temperature is equal to the ice vapor temperature. A combination of thermal mass, radiative surface area on the CT, and con-ops of CT haulers will provide sufficient CT passive cooling.

### Thermal Mining Sizing

A thermal mining sizing solution for water extraction of 2,450 MT per year (producing 1,640 MT of propellant per year) is shown in Table 1. Thermal mining can be scaled to meet any water extraction goal, larger or smaller by scaling the tent or adding more tents, CTs, and other thermal mining system elements. In this scenario, the dwell time, move time, and downtime, were fixed for both scenarios. Extractable ice per surface area is estimated to be 25 kg/m<sup>2</sup> and 250 kg/m<sup>2</sup> for 4wt% and 30wt% regions respectively. The solution includes tents of 32 m and 10 m diameter again, for 4wt% and 30wt% regions respectively. A single tent would need to be placed 128 times per year. Additional tents would provide additional margin. The number of ice haulers depends on the density of ice in the CT, volume of CT, ice-hauler traverse speed, distance between ice field and processing station, and transfer time at the processing station.

**Table 1: Thermal Mining Design for 4wt% and 30wt% Regions**

Requirement	Value (4wt%)	Value (30wt%)
Area Mined (m <sup>2</sup> /year)	100,000	10,000
Yield per m <sup>2</sup> (kg)	25	250
Ice sublimated per m <sup>2</sup> (kg)	27	280
Dwell time (hour)	48	
Move time (hour)	12	
Number of moves per year	128	
Power (kW)	580	370
Tent diameter (m)	32	10
Tent plan area(m <sup>2</sup> )	780	76
Exit area to cold traps (m <sup>2</sup> )	2	
Leak area (m <sup>2</sup> )	0.2	

### Processing<sup>25</sup>

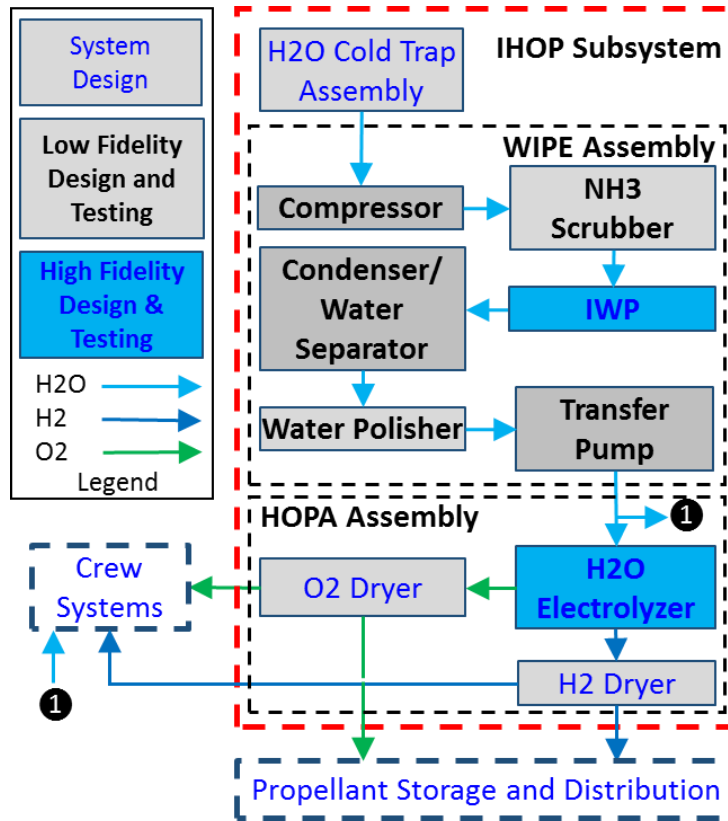
After water is extracted from the Permanently Shadowed Regions (PSR) of the Moon, it is processed to purify and electrolyze the water into hydrogen (H<sub>2</sub>) and oxygen (O<sub>2</sub>). Paragon Space Development Corporation (Paragon)<sup>26</sup> and its partner Giner, Inc. (Giner) are developing the ISRU-derived water purification and Hydrogen Oxygen Production (IHOP) subsystem through a recently awarded NASA Next Space Technologies for Exploration Partnerships-2 (NextSTEP)-2 Broad Agency Announcement (BAA) contract. Paragon’s Ionomer-membrane Water Processing (IWP) technology is optimized to perform primary water purification for this ISRU application. The purified water receives final polishing and is then electrolyzed using a Giner static feed water electrolyzer to produce H<sub>2</sub> and O<sub>2</sub> propellant. As shown in Figure 18, IHOP integrates and closely couples water purification and water electrolysis components to:

- Ensure water quality for the electrolyzer is always maintained
- Establish “smart process string” sizing to maximize robustness, reliability, and scalable propellant production rates while precluding 0-fault tolerance
- Allow the core IHOP technologies to be more easily integrated with alternative upstream raw water collection subsystems and downstream propellant production subsystems

<sup>25</sup> Section Authors: Laura Kelsey, Paragon Space Development Corporation, Principal Investigator; Barry Finger, Paragon Space Development Corporation, Chief Engineer

<sup>26</sup> <http://www.paragonsdc.com/>

- Optimize thermal management between two components that have very similar operating temperature requirements, and appreciable electrical power requirements
- Minimize intermediate product (water, hydrogen and oxygen) storage requirements



**Figure 18: IHOP System Flow Diagram**

*All IHOP components will be developed through System Design. Seven components will undergo full-scale testing under relevant conditions to advance their TRL. Two of the seven components will be high fidelity prototypes while the other five are fully functional but of lower fidelity. Integrated testing of the WIPE and HOPA Assemblies will be performed again at full-scale and under relevant conditions to demonstrate the integrated performance of these key components.*

The key assemblies and components that comprise IHOP are briefly described below.

### **Cold Trap**

While IHOP can be configured to receive raw ISRU-derived water from a variety of upstream subsystems, Paragon has configured this implementation of IHOP to accept raw water that has been collected as frozen ice in a CT notionally shown in Figure 19.



**Figure 19: Ice Collection Plates of a Commercial CT**  
*Operated by Paragon to manage water in their vacuum test facilities.*

The water excavated from the lunar regolith will not be pure, and its composition is expected to be similar to compounds found in the lunar crater Cabeus by the LCROSS mission and listed in Table 2 [14]. Thus as the first step in the water purification process, it is critical that the CT temperature be managed to selectively freeze out water (273.15 K freezing point), while minimizing the collection of lower freezing point volatiles (e.g. the respective freezing points of H<sub>2</sub>S and NH<sub>3</sub> are 191.15K and 195.85K). This integrated and system-level approach will improve overall performance of the propellant production system concerning landed mass, power, and volume requirements.

**Table 2: Lunar Water Contaminant Loading**

Compound	Concentration (%m relative to H <sub>2</sub> O)
H <sub>2</sub> O	100%
H <sub>2</sub> S	16.75%
NH <sub>3</sub>	6.03%
SO <sub>2</sub>	3.19%
C <sub>2</sub> H <sub>4</sub>	3.12%
CO <sub>2</sub>	2.17%
CH <sub>3</sub> OH	1.55%
CH <sub>4</sub>	0.65%
OH	0.03%
Hg	not available
CO	not available



### **Water Purification**

The Water, ISRU-derived, Purification Equipment (WIPE) Assembly encompasses all components required to purify raw ISRU-derived wastewater to levels appropriate for long-term propellant production via the electrolysis of water to H<sub>2</sub> and O<sub>2</sub>. At its core, WIPE employs a customized membrane distillation architecture that incorporates Paragon's patented IWP technology (Figure 20). IWP optimizes the application and integration of membrane materials into the water processing train to realize a rugged, effective, and efficient contaminant removal process that removes acid and water-soluble contaminants entrained in water extracted from the lunar regolith. The technology basis for this ISRU-derived water processing application builds off preliminary work completed by Paragon under previous NASA Small Business Innovation Research (SBIR) contract awards. The Contaminant Robust In-Situ Water Extraction (CRIWE) program assessed the application of IWP technology for in situ recovery of water from lunar, Martian, and asteroid regolith [45]. CRIWE achieved TRL 4 at the end of a NASA Phase 2 SBIR contract. This application focused on water recovery from Martian soil, specifically separating water vapor from a gas mixture consisting of carbon dioxide, water, chlorine, and hydrochloric acid. Full scale testing of CRIWE was performed in a lab environment at anticipated ISRU operating flow rates, pressures, and temperatures according to conceptual system design and analysis. Testing demonstrated high water recovery rates (>90%) and high contaminant rejection (95%-99%). Other related IWP projects include water recovery from urine brine via Paragon's Brine Processor Assembly (BPA) and purification of planetary wastewater via the Integrated-water Recovery Assembly (IRA). BPA is being delivered to NASA for a 1-year demonstration on International Space Station (ISS) in 2019 and IRA is under development via a Phase II SBIR contract [46] [47]. WIPE balance of plant components include an ammonia scrubber, water polisher, compressor, water condenser/separator, and transfer pump, all derived from mature spaceflight and/or terrestrial hardware solutions.

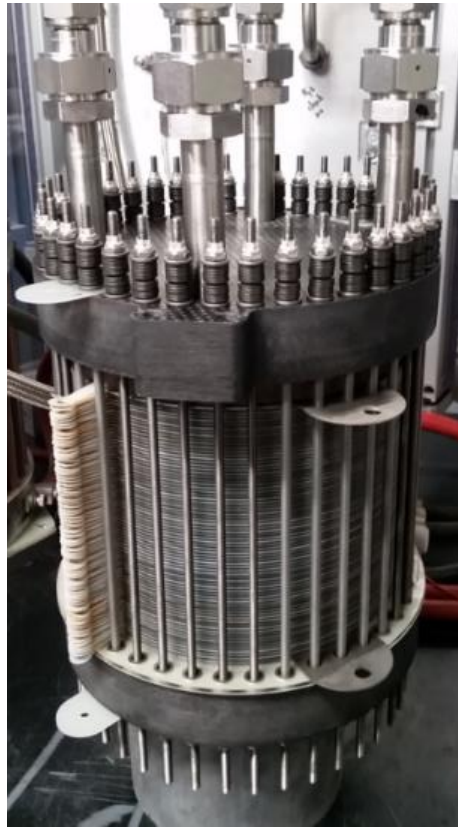


**Figure 20: Customized IWP Membrane Module**

*Flight qualified for humidity control aboard the Boeing CST-100 crew-transport spacecraft.*

## Electrolysis

Hydrogen Oxygen Production Assembly (HOPA) integrates Giner Labs<sup>27</sup> high pressure static feed water electrolyzer technology with an innovative product gas dryer approach to generate hydrogen and oxygen that can be directly utilized by propellant production subsystems. The lightweight, high-pressure water electrolyzer technology produces dry oxygen and hydrogen at a pressure of up to 80 bar (1160 psig) using the purified water generated by the WIPE Assembly. Giner's electrolyzer technology incorporates carbon fiber compression plates and a cell pitch of less than three millimeters. This electrolyzer, developed for aerospace applications, is highly scalable and durable. Currently, two of these stacks are operating in the field as high-pressure gas generators in aerospace regenerative fuel cell demonstration units. A 72-cell version of this stack is shown in Figure 21. Giner's lightweight water electrolyzer is at TRL 4 and it has been utilized in several fully functional aerospace demonstration tests<sup>28</sup>. Testing with respect to the effects of cold storage and longer term testing will advance the TRL of the technology. Balance of plant components are all at least at TRL 4, with many such as pumps, valve, motors, etc. being at considerably higher TRL given heritage to similar spaceflight components. Given that IHOP is located in a PSR of the Moon, the extremely cold environment (as low as 40 K) can be utilized to realize very simple H<sub>2</sub> and O<sub>2</sub> dryer components by simply implementing the same basic CT approach utilized by the CT Assembly.



**Figure 21: Giner 72-Cell Electrolyzer Stack**

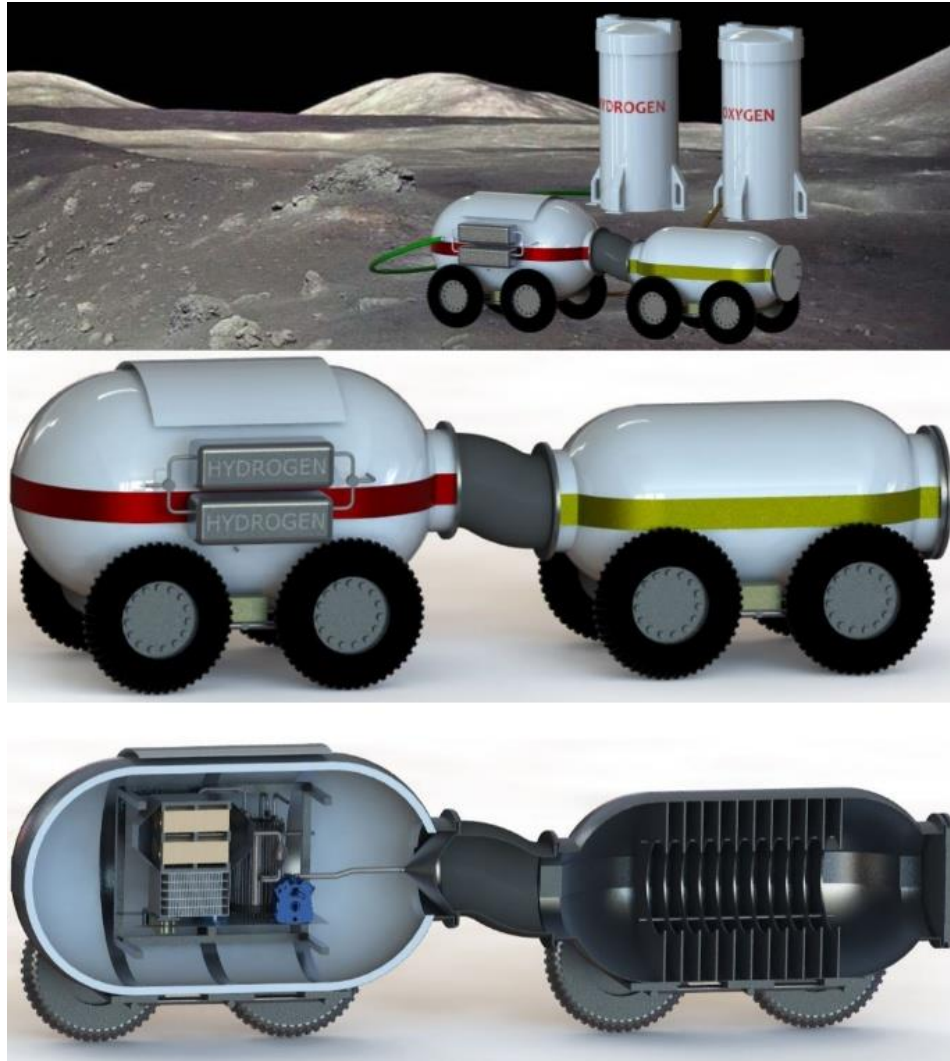
---

<sup>27</sup> <https://www.ginerinc.com/>

<sup>28</sup> [https://static1.squarespace.com/static/53acbe54e4b0c97fd0664882/t/59c93f6d12abd9f4e104e966/1506361199674/GinerELX\\_ESMC.pdf](https://static1.squarespace.com/static/53acbe54e4b0c97fd0664882/t/59c93f6d12abd9f4e104e966/1506361199674/GinerELX_ESMC.pdf)

### **Integrated System Solution**

The CT, WIPE, and HOPA assemblies are combined into a system-level design solution to realize an optimized water purification and propellant production solution for planetary/lunar surfaces. Key components of these assemblies have benefitted from previous development efforts for different applications. Ongoing development and testing under relevant conditions will result in an optimized integrated subsystem ready to be integrated into ISRU system-level solutions for the production of H<sub>2</sub> and O<sub>2</sub> propellants from lunar and Mars resources (Figure 22).



**Figure 22: Conceptual Packaging of IHOP with Mobile Robotic Transports**

*Expected to be implemented with the lunar propellant production architecture. The IHOP system is shown integrated into the vehicle on the left and the CT is shown integrated into the vehicle on the right. This mobile configuration could support operations dispersed over the large areas required for industrial scale propellant production.*



## **Propellant Storage**

### **Repurposed Surface Storage Tanks<sup>29</sup>**

Once LH2 and LO2 are created on the Moon, there is the question of where to store and stockpile it for the next flight. Rather than carry dedicated storage tanks, it is entirely logical to store the propellant in used propulsive stages. Particularly in the emplacement phase bringing the mining, processing, and power equipment to the Moon, there will be a large number of expended stages on the surface. In the later operations phase, refueling and reuse of stages will reduce the opportunity to leverage surplus stages for storage.

Though one could talk about physically moving these stages together, or robotically creating a pipeline between them, it is much easier to fill these stages in the places they land within the shadowed crater. A cryo “airport tanker” would drive fuel from the production facility to storage stages and from storage stages to operational reusable landers/ascenders to bring propellant and cargo to orbit and then return.

With smart lander design, avoiding a single central engine that sprays debris in all directions, and instead using a thruster arrangement with a preferred axis (no debris out the front or back, only the sides) could be ideal for creating a “debris-free” landing path. One could imagine that landers will naturally line-up along this path in order to minimize debris damage to already placed hardware. A crude road running along this string of landers creates the path for the tanker rover to bring and return propellant. Each storage tank stage would have to maintain proper thermal conditions, with transfer valve control, LOX heaters, possible LH2 cryocoolers, and RF status telemetry back to the central control. Cryogenic landers will have good insulation, and the lunar polar thermal environment is amazingly cold, driving the need for heaters for LOX rather than refrigeration. Heaters could be by a deployed cable, or using a small fuel cell to provide local heat and power. The cold temperatures in the lunar craters brings into question whether cryocoolers would even be needed for LH2 to be adequately maintained after it leaves the production facility. Heat leaks from the warmer LOX and limited avionics could affect LH2 boiloff and should be evaluated.

### **In-Space Specifications<sup>30</sup>**

In order to support a variety of propellant customers in cislunar space, there is a need for reusable space tugs, Moon shuttles, and refueling stations (Figure 23 and Figure 24). Propellant storage is a critical function, especially for cryogenic hydrogen and oxygen produced from lunar water. In addition, where non-ISRU propellants or pressurants are used in the tugs (examples listed in Table 3), additional depots within cislunar space may be required. Obviously, it is desirable to maximize the use of ISRU-derived LH2/LO2 systems to minimize the need for storage of Earth delivered propellants.

---

<sup>29</sup> Section Author: Jonathan Barr, United Launch Alliance, Project Manager

<sup>30</sup> Section Author: Dallas Bienhoff, Cislunar Space Development Company LLC, Founder

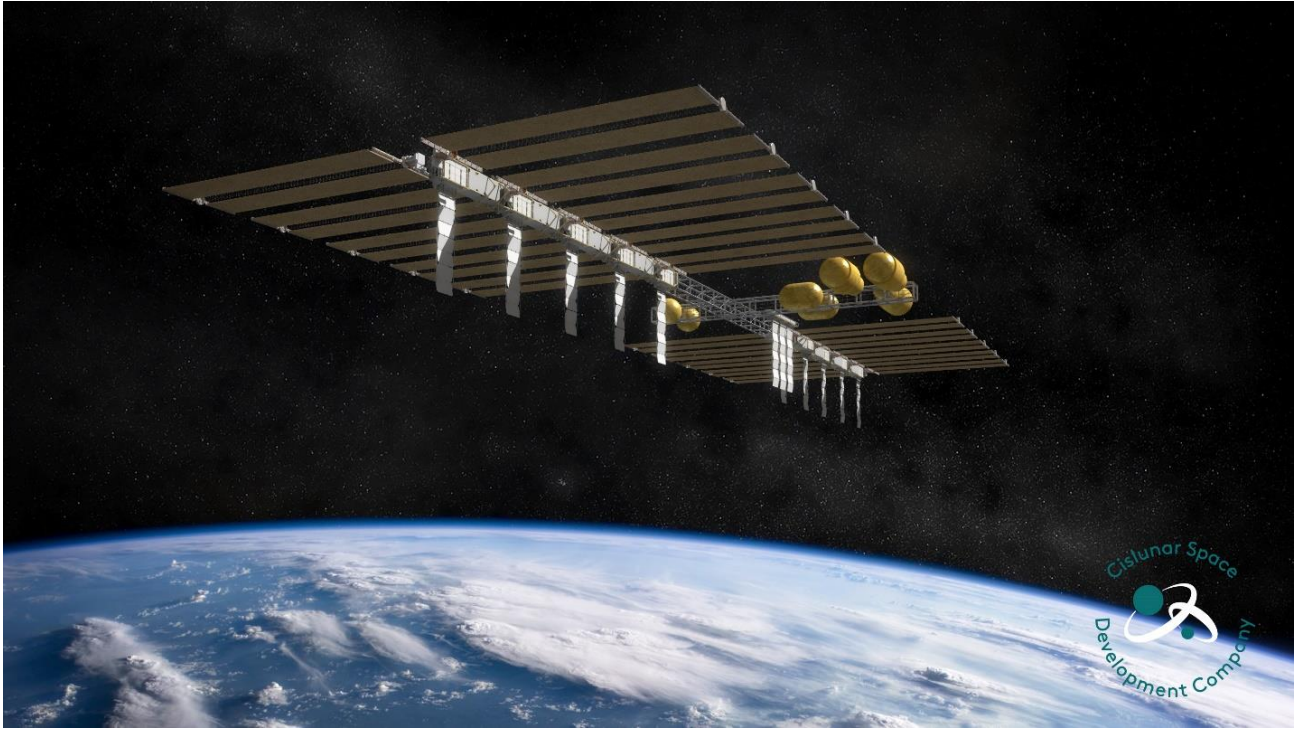


Figure 23: LEO Propellant Depot<sup>31</sup>

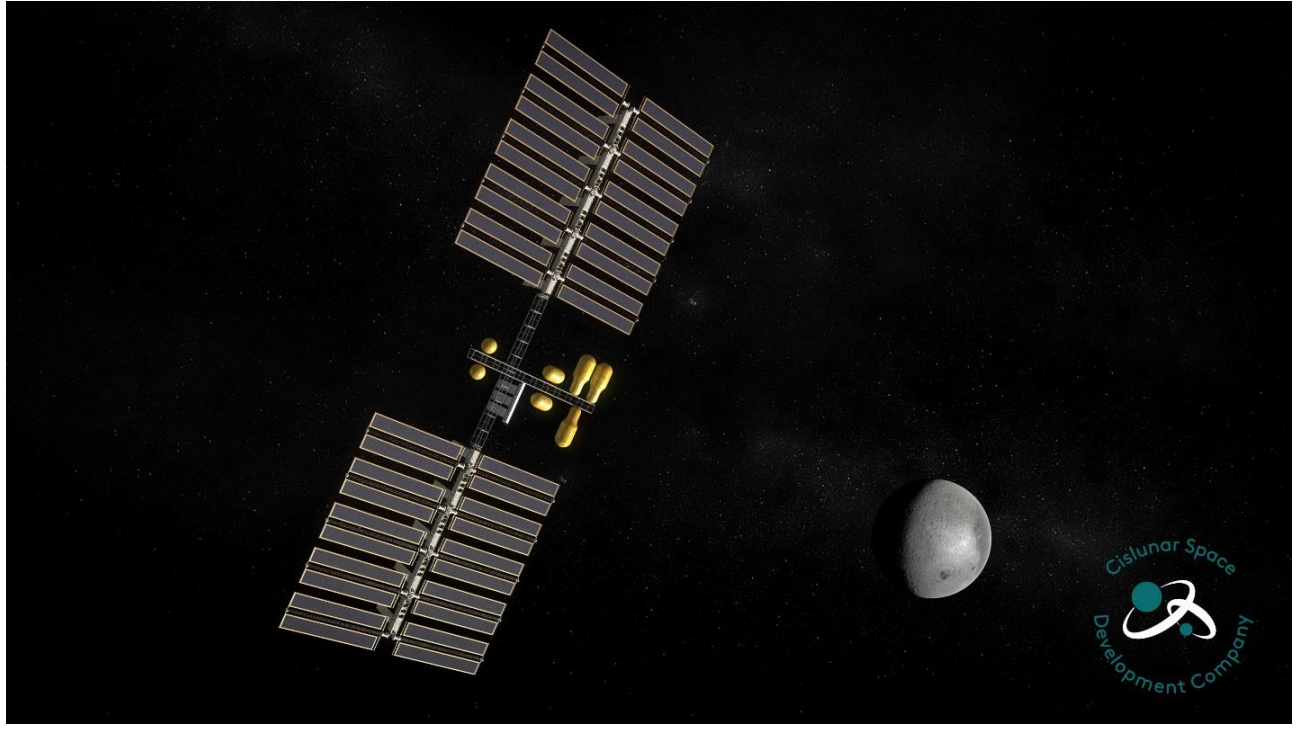


Figure 24: Lunar Orbit Propellant Depot<sup>32</sup>

<sup>31</sup> Image Credit: Bryan Versteeg

<sup>32</sup> Image Credit: Bryan Versteeg

**Table 3: Cislunar Space Propellants**  
*Potential Users and Properties*

Propellant	Organization	User	Density (kg/m <sup>3</sup> )	Freezing Pt. (K)	Boiling Pt. (K)
Kerosene	Firefly Vector Virgin Orbit	LV upper stage	820	200	420
Hydrazine	Satellite operators NASA Moon Express Astrobotic	Satellites Mars transfer vehicle Lunar lander	1021	275	387
Water	NASA Propellant suppliers	People Propellant depot	1000	273.15	373.13
Nitrogen Tetroxide	Satellite operators NASA Moon Express	Satellites Mars transfer vehicle Lunar lander	1442	261.9	294.8
Mixed Oxides of Nitrogen	Astrobotic	Lunar lander	1370	109.4	218 - 258
Xenon	Satellite operators NASA	Satellites Gateway Mart transfer	2942	161.4	165.05
Krypton	NASA	Gateway Mars transfer	3749	115.78	119.93
Methane	SpaceX	Vehicles	442.62	90.7	111.65
Natural Gas	Blue Origin	New Glenn LV	430 - 470	90.6	111.6
Oxygen	Blue Origin CSDC ULA	People Vehicles Fuel cells	1141	54.36	90.2
Argon	NASA	Gateway Mars transfer	1784	83.8	87.3
Hydrogen	Blue Origin CSDC ULA	Vehicles Fuel cells	70.8	14.01	20.28

Successfully storing these various propellants in cislunar space requires heaters to preclude freezing and cryocoolers to eliminate or minimize boil-off. Most propellants in Table 3 cannot be produced from raw materials found on the Moon so they would have to be delivered from Earth.

If storage of unprocessed lunar water is required, several technical solutions exist. Strip heaters are mounted on storage tanks wrapped in Multi-Layer Insulation (MLI) to provide sufficient energy to maintain tank wall temperature a few degrees above 273 K. This method would be used for transporting water from the lunar extraction facility to the propellant production facility. If the water is removed from the Permanently Shadowed Regions (PSR), the MLI must also provide sufficient protection when exposed to sunlight to keep the tank wall a few degrees below 373 K to prevent boiling. Circumferential heat pipes may also be used to transport heat from the sun side to the shade side thereby reducing the amount of energy required to prevent freezing. These approaches can be used for depots storing water in LEO, near the Moon and between propellant depots.

Hydrazine, nitrogen tetroxide and kerosene are similar to water in that they have high boiling points and need to be kept warm to prevent freezing. They freeze between 200 and 275 K and boil between 295

and 420 K. Additional propellants with similar storage requirements includes liquid noble elements, methane, liquid natural gas and oxygen. Their boiling points are between 87 K and 165 K. These liquids need to be stored in tanks that intercept incoming environmental heat and radiate it to space to prevent boil-off loss.

Three technologies need to be incorporated into cryogenic oxygen storage tanks located in cislunar space: MLI, broad area cooling and cryocoolers. MLI reduces the heat load from the Sun, Earth and Moon that reaches the tank outer wall. Broad area cooling is accomplished by attaching coolant tubes to the outer tank wall carrying a refrigerant that is below the propellant boiling point. The cryocooler compresses the refrigerant to increase its temperature, circulates it through radiators to reject the heat to Space, then expands the refrigerant to reduce its temperature and circulates it around the tank to intercept incoming heat. Depending on propellants, LEO versus cislunar orbits, and on thermal protection such as the use of sunshields and broad area cooling, the need for cryocoolers and the scale of cryocoolers can vary significantly.

Hydrogen, with its 20.28 K boiling point, is the hardest propellant to keep from boiling. The same technologies used to prevent oxygen, liquid noble elements, methane and liquid natural gas from boiling are required for hydrogen. The difference is two broad area-cooling layers with MLI between them are needed for hydrogen: the outer layer is tubing on a shell around the tank with refrigerant at 80 to 100 K; the other is tubing on the tank with refrigerant below hydrogen's boiling point. Sunshields offer an alternative to broad area cooling.

These technologies have been ground tested by NASA under the Cryogenic Propellant Storage and Transfer Project and eCryo Project and were ready for Space flight tests in 2012 [48]. Quest has developed various MLI concepts and demonstrated the ability to limit heat flow to less than  $0.5 \text{ W/m}^2$  with an area density between 1500 and 3000  $\text{g/m}^2$ <sup>(33)</sup>. Creare has developed and tested 90K and 20K cryocoolers using helium as the working fluid with Carnot performance around 0.1 [49].

---

<sup>33</sup> Quest Thermal Group, Integrated Multi-Layer Insulation Specifications Sheet, <http://www.questthermal.com/imli-specification-sheet>





**Power**

## Requirements<sup>34</sup>

Using electrolysis to produce LOX and LH2 from water requires approximately 4.41 kWh/kg [50]. The Demand section will further elaborate, but the architecture defined in this study must process 2,450 MT of water per year to meet propellant demand equivalent to 280 kg/hr. It is then determined that 1,235 kW<sub>e</sub> are required for electrolysis alone. Experts contributing to this study provided estimates for additional electrical demand (robotic systems, pumps, cryocooler, heaters, communications, etc.) that would account for an additional 765 kW<sub>e</sub>. This has produced a need for 2 Megawatts (MW) electrical power production. In addition, as described in the Thermal Mining Sizing section, for the worst-case scenario of 4wt% water, sublimation for a yield of 2,450 MT of water requires 580 kW<sub>t</sub> thermal energy. Because there may be unforeseen efficiency losses or varying water concentration lower than 4% in some areas, we have conservatively rounded this up to 800 kW<sub>t</sub> thermal energy. Therefore, the total energy needs for this architecture is 2.8 MW, 2 MW<sub>e</sub> electrical and 0.8 MW<sub>t</sub> thermal, which dwarfs the 100 kW<sub>e</sub> class power of the ISS

## Overview<sup>35</sup>

Though there is considerable focus on lunar mining technology, the power infrastructure to provide the energy to mine and refine ice and water from lunar polar craters represents significant infrastructure. The two obvious paths are nuclear power, and solar power. The options are discussed more fully in the following sections.

Nuclear power is relatively straightforward. Our requirements of 800 kW<sub>t</sub> of thermal or electrical power for mining, and 2 MW<sub>e</sub> of electric power for ice processing represent large power values. These power levels are too big for the kilo-power reactors that have been NASA's recent focus. A technology need is for the United States Government (USG) to revisit space compatible MW class reactors. Two private companies, Atomos Nuclear and Space<sup>36</sup> and USNC<sup>37</sup>, however, are working to develop Space reactors with power levels from 150 kW<sub>e</sub> to 1,000 kW<sub>e</sub> and mass around 5,000 kg. At 30% efficiency, these reactors will need to reject 300 to 2,000 kW<sub>t</sub> thermal that may be radiated or utilized for thermal mining.

With Solar power, there are multiple options, with the complexity in the trade space driven by the requirement for getting the solar energy from the nearly constantly illuminated rim of the crater down to the mining and processing infrastructure in the permanently shadowed bottoms of these craters. In most cases, these distances are in kilometers. Options include:

1. Heliostats directly reflecting the solar energy into the crater where it can be used to sublimate ice and/or converted with Photovoltaics (PV)s inside the crater into electricity.
2. Beamed microwaves or lasers to transmit the power after PV conversion on the rim.
3. "Extension cords" to conduct the electric power from PVs on the rim into the crater.

Unlike nuclear power, which is very site agnostic, these various solar power transmission options should be sensitive to the scale of the crater. Extension cords would be an obvious solution for a small crater, but would require engineering to enable transmission across part of a large crater like Shackleton, and is discussed below. Heliostats and power beaming solutions have their own less obvious sensitivities to scale.

---

<sup>34</sup> Section Authors: David Kornuta, United Launch Alliance, CisLunar Project Lead; and Dallas Bienhoff, CisLunar Space Development Company LLC, Founder

<sup>35</sup> Section Author: Jonathan Barr, United Launch Alliance, Project Manager

<sup>36</sup> <https://atomosnuclear.com/>

<sup>37</sup> <https://usnc.com/>

## Photovoltaics<sup>38</sup>

Solar arrays are an obvious solution for producing electricity in Space and on the Moon. Solar arrays must be supplemented with energy storage devices, such as batteries, to maintain operations while blocked from the Sun. On the Moon, solar obscuration can vary from just a few hours a month in the Polar Regions to as much as 14 days each month near the equator.

Deployable Space Systems (DSS)<sup>39</sup> and Northrop Grumman Innovation Systems (NGIS)<sup>40</sup> have developed solar arrays that are more efficient in electricity production, specific mass and stowed density than those on ISS. DSS's Roll Out Solar Array (ROSA) deploy and stow operations were demonstrated on ISS in 2017. Due to its extremely thin solar array blanket, the ROSA can be compactly stowed in a cylinder for launch. NGIS's MegaFlex solar arrays can provide 30 to 300 kW in a circular configuration that unfolds circumferentially from a small prismatic storage configuration.

The system starts with deployed, vertically oriented, flat PV panels that can be rotated 360 degrees around the vertical axis (since at the poles the sun will always be close to the horizon). We expect these will be in several clusters, rather than evenly spaced around the perimeter of the crater rim, to make deployment simpler. Whether we have fewer larger PV towers or additional smaller PV towers is driven by volumetric packaging constraints. We assumed 15 individual panels of 900 sq. m each to meet our power requirement assuming 29%<sup>41</sup> PV efficiency from ROSA and a 54% power beaming efficiency (discussed more in the Power Beaming section) to support the 2.8MW power requirement defined at the beginning of the power section. With no wind forces these structures, and fundamentally lightweight PV panels, the tower structure should be very lightweight and its structure is likely driven by their own self-induced deployment forces in the 1/6<sup>th</sup> G lunar gravity field. Creative structural solution such as inflatables should be explored since better packaging might permit fewer larger towers with a faster emplacement needing fewer delivery flights. Given that Heliostats, and PV panels fundamentally require a similar rotating tower (with acknowledged differences in pointing accuracy requirements), this would be fruitful area for future technology development.

Starting with the conversion of sunlight at the crater rim three deployable systems each capable of delivering up to 1 MW to the crater floor substation for servicing loads are assumed. Three technology solutions have been identified: direct PV (TRL 7 to 9), concentrator PV (TRL 7 to 9), and solar dynamic (TRL 5 to 7). Direct PV systems are assumed to have an insolation of one sun ( $I_{sc}$ ), capable of tracking the sun with constant illumination, and a Solar flux to DC conversion efficiency of 34% [51]. Concentrator PV systems are assumed to have an effective insolation of ten suns ( $10 \cdot I_{sc}$ ), capable of tracking the sun with constant illumination, and a Solar flux to DC maximum theoretical conversion efficiency of 65% [51]. Solar dynamic systems are assumed to have an insolation of ten suns ( $10 \cdot I_{sc}$ ), capable of tracking the sun with constant illumination, and a Solar flux to DC conversion efficiency of 34% using a heat engine [52] [53].

## Wired Power Transmission<sup>42</sup>

Getting converted photovoltaic power from a lunar crater rim represents a challenge. Wired transmission (the “extension cord”) represents an interesting option. With a huge variation in shadowed

---

<sup>38</sup> Section Authors: Dallas Bienhoff, Cislunar Space Development Company LLC, Founder; Jonathan Barr, United Launch Alliance, Program Manager; and Gary Barnhard, Xtraordinary Innovative Space Partnership, CEO

<sup>39</sup> <https://www.dss-space.com/>

<sup>40</sup> <http://www.northropgrumman.com>

<sup>41</sup> [https://www.lpi.usra.edu/opag/meetings/aug2015/presentations/day-2/11\\_beauchamp.pdf](https://www.lpi.usra.edu/opag/meetings/aug2015/presentations/day-2/11_beauchamp.pdf)

<sup>42</sup> Section Authors: Gordon Roesler, Robots in Space LLC, President; and Jonathan Barr, United Launch Alliance, Program Manager

crater diameters, wired transmission might make sense for smaller craters where the mass of the conductor could be minimized. Apart from mass, the ability to lay wires on the regolith down steep slopes, or suspended between towers robotically creates its own deployment challenges, and may create opportunities for creative solutions for deploying the cable. Recent 2018 data on the distribution of water within the lunar polar craters appears to show water in the largest, deepest craters, which may weigh against the feasibility of an approach best suited for smaller shallower craters. Though the “extension cord” creates its own challenges, the avoidance of a >50% loss for microwave or laser transmission holds a fundamental benefit.

Copper is conventionally used as a conductor, and cryogenically cold temperatures can improve conductivity by a factor of five at 40 degrees K. Gordon Roesler, of Robots in Space, has put forward the concept of using beryllium ribbon. Beryllium’s resistance is much lower than copper’s at the low temperatures within the craters, and it is a much lighter material<sup>43</sup>. A further game changer might be the use of superconducting wires once past the hot rim of the crater and into the Permanently Shadowed Regions (PSR). To our knowledge, wired power transmission in a lunar crater has not been explored fully. If tracks are installed to improve the mobility and survivability of robotic vehicles, these could also be used to incorporate or support transmission lines.

### **Power Beaming<sup>44</sup>**

Power can be transmitted wirelessly using either Microwave or Laser transmission power beaming technology. Conversion efficiency from DC power to microwave radiant energy (and the reverse) varies as a function of frequency with efficiency typically falling off as frequency increases. However, as frequency increases the area of the transmission aperture and reception aperture (rectenna) decrease. Accordingly, for any given technology solution instance there is an optimum frequency that optimizes efficiency, mass, and area/volume. Since the lunar atmosphere is negligible, free space transmission losses via microwave transmission are treated as negligible. The system end-to-end overall efficiency record still stands at 54% but advances in the state-of-the-art that would be incorporated in any fielded system are anticipated to exceed this value [54] [55]. For comparison purposes, a rectenna yields a specific power of 4,000 W/kg [56], while the use of on-board solar arrays would yield a specific power of approximately 70-90 W/ kg [57]. In the Photovoltaics section, we described the assumption of three discreet clusters of photovoltaics. We assumed separate rectenna for each photovoltaic cluster given their wide angular separation

Conversion efficiency of a solar-pumped laser using a semiconductor as the lasing material should allow efficiencies approaching 35% to be achieved at a wavelength near that of optimum conversion efficiency by PV cells [58].

Storage/buffering of power is appropriate at the primary conversion point, at the crater floor substation, and/or at the actual electrical load point of use. Allocation of these capabilities between these locations needs to be optimized to assure normal continuous operations as well as the ability to deal with contingency shut down situations.

### **Heliostat<sup>45</sup>**

Heliostats track the sun in two axes and concentrate sun light to a small-aperture receiver, as illustrated in Figure 25. The receiver runs heat transfer fluid (HTF, such as air, steam, molten salt or solid particles) to absorb sunrays in a form of thermal power. The heated HTF at the receiver outlet can then be used to

---

<sup>43</sup> F.M.Mueller et al., Hyperconductivity in chilled beryllium metal, Appl. Phys. Lett. 57(3), 240-242 (1990).

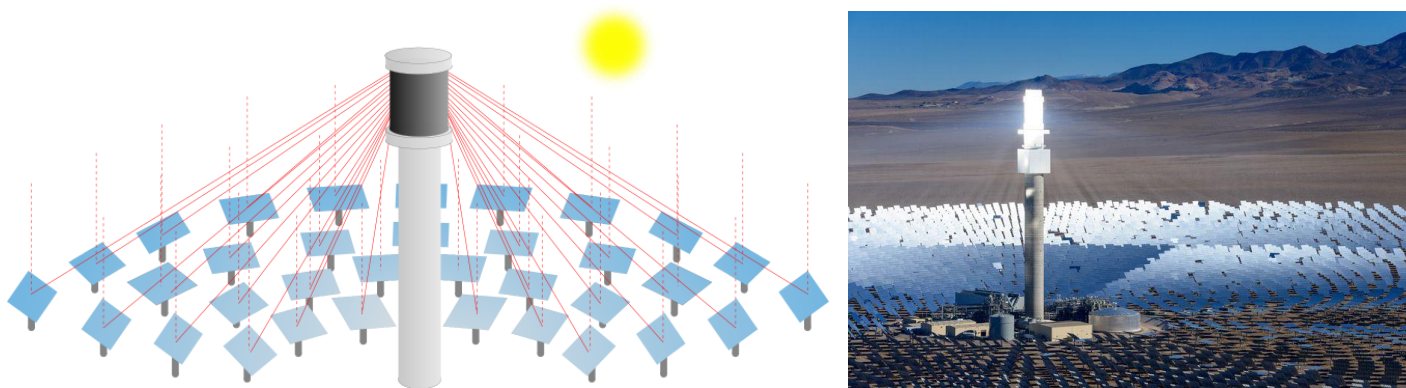
<sup>44</sup> Section Author: Gary Barnhard, Xtraordinary Innovative Space Partnership, CEO

<sup>45</sup> Section Author: Guangdong Zhu, National Renewable Energy Laboratory, Senior Researcher

indirectly produce electricity through a thermodynamic cycle (steam Rankine cycle, air Brayton cycle or supercritical CO<sub>2</sub> cycle) or directly supply industrial process heat in various applications. Focusing sunlight onto a centrally located power tower is classified as a type of point-focus Concentrating Solar Power (CSP) technology. The power tower technology using heliostat has been commercialized in a utility scale in the United States (US) and around the world, and total installed capacity reaches 0.63 GW<sub>e</sub> under operation and 4.88 GW<sub>e</sub> under construction or development in the future<sup>46</sup>. Coupled with low-cost thermal energy storage system, a general CSP technology can deliver and dispatch power at hours the grid needs, not constrained by the intermittent solar irradiation.

The solar-to-thermal efficiency of a heliostat field depends the following major factors:

- Sun shape and position. The finite size of the sun shape will limit the concentration ratio of a power tower system using heliostats [59].
- Optical error of heliostats, such as mirror slope error and tracking error. All optical errors will effectively enlarge the sun shape, further reducing the concentration ratio limit [60].
- Heliostat field layout. Shading/blocking loss from neighboring heliostats may be significant if the spacing is too small.



**Figure 25: Working Principle of Heliostats**

*(Left) Conceptual schematic of concentrating solar power tower using heliostats [61].  
(Right) An operating heliostat field concentrating solar light to the receiver on a tower<sup>47</sup>.*

### **On the Moon**

Heliostats can be used to direct sunrays to the workstation at the bottom of a crater on the Moon. As illustrated in Figure 26, heliostats are placed at the edge of a crater and track the sun and concentrate sun light (Figure 26a) and the concentrated sun light reaches the tent-like workstation using secondary optics to distribute the light to the ground (Figure 26b). Distributed sun light then heat the ground for sublimation.

In this application, heliostats can be placed at several locations around the circumference of the crater so there will always be working heliostats to deliver power to the workstation as long as the sun is above the horizon. The tent surface can also be equipped with PV cells to produce electricity if needed.

<sup>46</sup> "World CSP projects." from <https://www.nrel.gov/csp/solarpaces/>

<sup>47</sup> Solar Reserve (2015). "Crescent Dunes Solar Power Tower Plant." from <http://www.solarreserve.com/en/global-projects/csp/crescent-dunes>

The key design parameters include, but not limited to:

- The crater dimensions. When the distance between heliostats and workstation exceed certain range, the system efficiency may diminish quickly.
- The heliostat quality including specular reflectance, specularity, slope error and tracking error.
- The heliostat locations, which will decide power generation variation at workstation.
- Heliostat packing mechanism for transportation and remote deployment.



**Figure 26: Conceptual Power System Using Heliostats at a Moon Crater**

(Left) (a) Heliostat concentrating sun lights to the working station at the bottom of a crater on the Moon [42]

(Right) (b) The conceptual light collection tent design for sublimation out of the Moon ground [42].

### Nuclear Fission<sup>48</sup>

Nuclear power is not new for space applications. It can be safe, effective, and efficient for long-term and long-duration spaceflight, and has the potential to greatly enhance and enable solar system exploration. With key advantages including independence from the availability of solar energy, low specific mass<sup>49</sup>, high power densities, and long operational lifetimes, nuclear power could be the preferable choice for future space operations missions if regulatory barriers can be overcome [62].

There are two main categories for modern space nuclear power systems; radioisotope sources and fission reactors. RTGs are thermal batteries, utilizing the decay heat of radioisotopes to produce electrical power for watt-level applications [62]. RTGs have been used extensively by the US<sup>50</sup>; however, RTGs appear poorly matched to the power levels needed for ISRU. NASA flew a single Fission Reactor Demonstrator Mission<sup>51</sup> in the 1960s. The former Soviet Union has more thoroughly explored the applications of reactor technology to space missions, having flown over 30 fission-powered spacecraft.

A summary of the lunar propellant production needs and NASA's ongoing nuclear activities is shown below (Table 4). Despite the ongoing activities listed in Table 4, space nuclear fission power programs are not prioritized by the US<sup>52</sup>, and NASA has no currently funded high-power nuclear fission power programs.

<sup>48</sup> Section Author: Vanessa Clark, Atomos Nuclear and Space, Chief Executive and Technology Officer

<sup>49</sup> Specific power is the ratio of power system mass (in kg) to power output (in kW<sub>e</sub>). In powering a spacecraft for electric propulsion purposes, this figure should be as low as possible.

<sup>50</sup> Cassini, Mars Science Laboratory (Curiosity Rover), Voyager are notable NASA spacecraft and rovers powered by RTGs [167]

<sup>51</sup> SNAP-10a, a 30kW<sub>e</sub> reactor, flew on a 43-day mission on the SNAPSHOT spacecraft in 1965 [62].

<sup>52</sup> Total funding for nuclear fission programs is less than \$100M annually. Most of this funding has been allocated to fund early research and development of a nuclear thermal propulsion (NTP) system, for which many of the materials-levels technologies are synergistic with megawatt-level nuclear power systems development. NTP reactors

The only active fission power program, Kilopower, received less than \$20M of funding at the time of writing. Even with severe budget limitations and initial lack of agency support, Kilopower, a 1-10kW<sub>e</sub> fission reactor jointly under development by NASA and the Department of Energy (DOE), completed a successful test campaign in 2018. Most significantly, Kilopower has served as a pathfinder, demonstrating that with correct application of technologies, use of existing facilities, and lean management, nuclear fission programs can be both successful and affordable [63].

**Table 4: Current USG Nuclear Programs Compared to Lunar Production Needs**

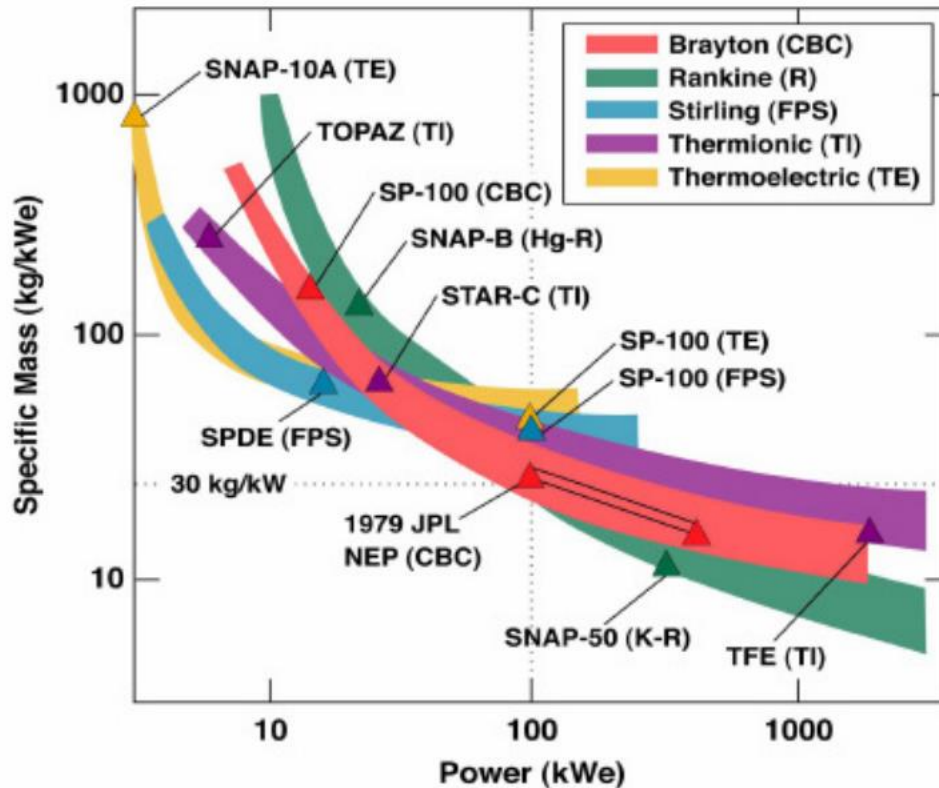
NASA Activities			Lunar Propellant Production Needs
Radioisotope power	Kilopower	Nuclear Thermal Propulsion	Megawatt-level power
<ul style="list-style-type: none"> <li>- Long duration</li> <li>- 100-500w<sub>e</sub> systems</li> <li>- Plutonium-238 decay heat</li> </ul> <b>Application:</b> robotic probes for scientific missions	<ul style="list-style-type: none"> <li>- Long duration</li> <li>- 1-10kw<sub>e</sub> systems</li> <li>- Highly enriched Uranium-235</li> </ul> <b>Application:</b> human exploration surface power needs (habitats, science experiments)	<ul style="list-style-type: none"> <li>- Short duration</li> <li>- 100+MW<sub>e</sub></li> <li>- Low-enriched Uranium-235 to heat hydrogen propellant to produce thrust</li> </ul> <b>Application:</b> propulsion for human flights to Mars	<ul style="list-style-type: none"> <li>- Long duration</li> <li>- 2.8MW system</li> <li>- Low-enriched Uranium-235, or alternate non-weaponizable fuel form</li> </ul> <b>Application:</b> water sublimation and fuel processing

Kilopower was designed for notional lunar and Mars surface NASA missions with electrical loads such as landers, habitats, mobility and construction equipment, and science experiments, and total power requirements ranging up to only 10kW<sub>e</sub> [64]. Unfortunately, the Kilopower reactor, or even Kilopower-derived technologies, do not appear to be translatable into the industrial-level use-case of the lunar propellant plant. Use of a few, high-power reactor rather than many smaller, lower-power units, such as Kilopower, is preferable for many space applications for a key reason: mass. Reactors scale well, with the specific mass of a reactor decreasing as power output increases (Figure 27 [65]). Given this relationship, using 280 10kW<sub>e</sub> Kilopower units to fulfil the 2.8MW power needs of the lunar propellant plant could be more than 10 times heavier than a single 2.8MW reactor (refer to Table 5, below).

**Table 5: (Right) Transportation of Various Power Systems to Cislunar 1000 Propellant Plant Depot**

NASA Nuclear Systems	Radioisotope power systems: <i>840MT total mass.</i>
	Kilopower: <i>420 MT total mass.</i>
	Nuclear thermal propulsion: <i>N/A; this reactor type is designed for hours of operation, only.</i>
Optimal Nuclear System	Megawatt-level fission reactor: <i>30MT total mass.</i>

are different in configuration and design to nuclear power reactors – with the former designed for extremely high-temperature, short duration (2-20 hours) operation and the latter designed for lower temperatures and lifetimes up to 20 years continuous operation.



**Figure 27: (Left) Reactor Specific Mass vs. Electric Power<sup>53</sup>**  
*Assuming 10MT lunar lander capacity*

The implications to transportation cost alone make megawatt-level nuclear fission power a highly interesting technology for the realization of the lunar propellant plant. While nuclear technologies have not seen a commercial application in space, this is not due to technical risk; rather, barriers for such systems have been development costs and regulatory processes. Yet, as demonstrated by Kilopower, development costs may be much lower than previously anticipated, particularly if completed in conjunction with industry and utilizing existing test infrastructure. As enterprises such as Atomos Nuclear and Space and BWXT develop megawatt-level, space-rated fission power systems for commercial applications, such as in-space transportation (as outlined in the Nuclear Electric Propulsion section), development costs of those systems become small compared to the lunar propellant plant.

#### **Megawatt Power on Lunar Surface<sup>54</sup>**

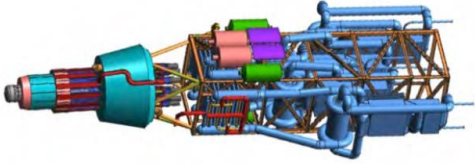
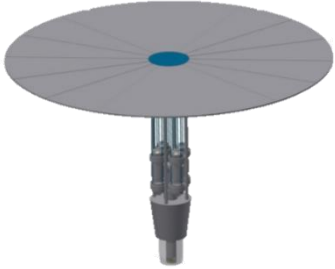
The key components of the reactor power system are the reactor core, reactor controls, reactor shielding, and electrical conversion system. An overview of these systems, notional baseline designs for a lunar propellant plant system, and comparison to the Kilopower systems, is shown in Table 6, below. Technology recommendations are based on outcomes of a trade study completed by Atomos Nuclear and Space. Atomos has concluded that Low Enriched Uranium (LEU) and a direct gas Bryton cycle are preferred, though this can be traded. The notion that power levels need to be scaled up significantly from Kilopower for this application is unavoidable.

<sup>53</sup> SNAP – Space Nuclear Auxiliary Power

<sup>54</sup> Section Author: Vanessa Clark, Atomos Nuclear and Space, Chief Executive and Technology Officer



**Table 6: Reactor technologies**

	<b>Optimal. Megawatt-level Nuclear Fission Reactor (3 x 1MW<sub>e</sub> individual units assumed)</b>	<b>Kilopower-Derived Reactor (10 x 300kW<sub>e</sub> individual units assumed)</b>
	 [66]	 [67]
<b>Core</b>	<p><b>Fuel:</b> High temperature, robust, commercial (e.g. derived from heritage commercial Earth-based small modular reactor fuel), utilizing low-enriched Uranium-235.<sup>55</sup></p> <p><b>Moderator:</b> Zirconium Hydride.<sup>56</sup></p> <p><b>Coolant:</b> Gaseous<sup>57</sup></p> <p><b>Outlet temperature:</b> 1150K (with growth to 1500K)<sup>58</sup></p> <p><b>Controls:</b> Rotating reflector drums</p>	<p><b>Fuel:</b> Uranium-Molybdenum metal, using highly enriched Uranium-235.<sup>59</sup></p> <p><b>Moderator:</b> None</p> <p><b>Coolant:</b> Sodium</p> <p><b>Outlet Temperature:</b> ~1000K</p> <p><b>Controls:</b> Neutron absorber rod</p>
<b>Shielding</b>	<p><b>Materials:</b> Layered Lithium Hydride and Tungsten.<sup>60</sup></p> <p><b>Configuration:</b> One side shielded (top side), shown below. Sides and base can be shielded effectively by submersion in lunar regolith.<sup>61</sup></p>	<p><b>Materials:</b> Per Megawatt-level reactor.</p> <p><b>Configuration:</b> Per Megawatt-level reactor. Use of highly enriched Uranium requires different relative shield geometry.</p>
<b>Conversion</b>	<p><b>Cycle:</b> Direct gas Brayton<sup>62</sup></p> <p><b>Radiator:</b> 640K heat pipe and carbon-carbon fins</p>	<p><b>Cycle:</b> Stirling<sup>63</sup></p> <p><b>Radiator:</b> Water/Titanium heat pipe and carbon-carbon fins</p>

There are additional considerations for reactor deployment, including use of process heat and system portability. Conversion from thermal to electrical power is approximately 20-35% efficient, requiring a 3 MW<sub>t</sub> reactor to produce 1 MW<sub>e</sub>. The ~2 MW<sub>t</sub> that is not converted to electrical energy must be rejected into space during normal system operation; however, this heat can be used for other applications. The power requirements for lunar propellant production is 2MW<sub>e</sub> electrical power for propellant processing, with the

<sup>55</sup> E.g. FCM-Triso fuel developed by Ultra Safe Nuclear Corporation [168].

<sup>56</sup> Moderator required for thermal reactor using low-enriched Uranium-235.

<sup>57</sup> Gaseous coolant selected to avoid phase-changes in microgravity.

<sup>58</sup> Higher outlet temperature allows for lighter conversion system and smaller radiator.

<sup>59</sup> This fuel has robustness and dimensional stability concerns, is incapable of high-temperature operation, and is therefore difficult to scale.

<sup>60</sup> Based on heritage DOE/NASA designs.

<sup>61</sup> Refer to [169]

<sup>62</sup> This conversion cycle scales well to high power levels (per Figure 27) and has strong heritage.

<sup>63</sup> This conversion cycle is simple, robust, and flight-ready.

remaining  $800\text{kW}_t$  allocation converted to thermal power for sublimation. Power for sublimation can therefore be supplied either in electrical form or directly as thermal power, if a method for transporting heat (e.g. portable, flexible working fluid tubing) to the sublimation site can be designed. This scheme still requires additional heat rejection but reduces it by a factor of two. During the workshop, we concluded that providing all power electrically (2.8 MW) including the  $0.8\text{ MW}_t$  for mining was preferred over providing  $2\text{ MW}_e$  and using waste heat for extraction. This was determined because providing and moving an electrical cable on the surface to mobile mining equipment is far simpler (and introduces less risk) than trying to deploy and shift plumbing with reactor coolant despite the higher reactor power required.

Portability of the system should also be considered carefully. If the mining area is excessively large and transportation of electrical (and/or thermal) power to the sublimation site from the reactor becomes impractical, a portable reactor may be considered. Such a system could require more shielding to allow for containment on an e.g. crawler vehicle. Shielding through submersion in lunar regolith might not be possible.

#### **Non-Technical System Considerations<sup>64</sup>**

Safety and environmental impact are key considerations. Nuclear fission systems are intrinsically much safer than RTGs. The fission reaction, and therefore radiation output of reactors, unlike RTGs, can be controlled. A new reactor can be maintained at a subcritical and benign state, only becoming activated once the reactor has exited the Earth environment and reached space after launch. There are space reactor design choices and standards that further enhance safety and operational reliability, many of which already have heritage in current-generation commercial ground reactors designed to be “walk-away safe”. These design features include: passive operation; decay heat removal; the use of very-temperature, dimensionally-stable fuels; the use of fission-product encapsulating fuel composites; the absence of single-point failures in the reactor design; explosion<sup>65</sup> and water submersion<sup>66</sup> subcriticality assurance; and the use and implementation of autonomous operation schemes and adaptive control capabilities [68].

Historically, space reactors flown or designed for the US and Russia used Highly Enriched Uranium (HEU) for fuel. LEU is defined as having less than 20% uranium 235 (U-235) enrichment. HEU usually produces a smaller and lighter reactor than LEU; however, HEU is also the simplest nuclear material to use for an improvised nuclear device, making it a national security concern. While the U-235 mass in a LEU core could be greater than a comparable HEU system, the lower enrichment means that the core material is practically impossible to weaponize. For this reason, LEU is commercially available for power applications in the US with less stringent security requirements for processing and transportation. With space agencies favoring HEU designs (e.g. Kilopower), security and proliferation concerns and costs associated with procurement and processing of restricted materials have been the key failure point in the US adoption of space nuclear.

Recent advancements in fuel and moderator material technologies improve reliability, performance, and safety considerations and enable LEU reactors to be reconsidered for space applications, particularly at high power levels. At lower power levels (up to approximately  $100\text{kW}_e$ ), a HEU system, including reactor and shielding, will be 30-50% lighter than a comparable LEU system. However, at power levels exceeding

---

<sup>64</sup> Section Author: Vanessa Clark, Atomos Nuclear and Space, Chief Executive and Technology Officer

<sup>65</sup> An important design consideration for space reactors is to assure that is no mechanism through which a reactor could become critical if the launch vehicle experiences a rapid unscheduled disassembly.

<sup>66</sup> Water acts a neutron moderator. Therefore thermal (moderated) reactors increase in criticality when submerged in water. Maintaining subcriticality in the event of water submersion (e.g. launch failure) must be a design consideration.

this (including at megawatt-level, as required by the lunar propellant plant) the performance discrepancy become insignificant. LEU is therefore a practical choice for the lunar fission plant since the selection comes with no impact to overall mass and performance.

The current regulatory status in the US for the launch of nuclear payloads is loosely defined. Established by Presidential Directive/NSC-25 [69], an ad hoc Interagency Nuclear Safety Review Panel (INSRP) consists of the Department of Defense (DoD), DOE, NASA, the Environmental Protection Agency and a technical advisor from the Nuclear Regulatory Commission. INSRP oversees and reviews three (partially) concurrent safety reports that coalesce into the final approval (or disapproval) for nuclear launch: Safety Analysis Review, Safety Evaluation Report, and Environmental Impact Statement (EIS)—with only EIS having any legislative backing through the National Environmental Policy Act. Historically, approval for launch has ranged from four to eight years, and while the majority has been for RTG systems that pose greater radiological risk in the event of launch failure (compared to fissions systems), the poorly defined, non-legislative process is difficult to plan for in a commercial entity.

Internationally, the non-legally binding “Principles Relevant to the Use of Nuclear Power Sources in Outer Space,” as with US policy, loosely defines operational limits to nuclear power in space. It states that it must operate in “sufficiently high orbits [...] long enough to allow for a sufficient decay of the fission products” or be stored in sufficiently high orbit after the “operational part of [its] mission” in a low-Earth orbit. Additionally, the principles document limits the use of uranium for space applications to highly enriched only, though this was contested by technical experts at the time of its writing [70]. Beyond this document, however, Article VI of the United Nations (UN) treaty on outer space [71] makes the US government legally responsible for its domestic, commercial space operations.

The legislative and executive branches of the US government have recently demonstrated strong interest in streamlining launch licensing [72] and delineation of agency authority for in-space operations, for which no oversight authority currently exists [73] [74] [75]. With slight variations between the approaches proposed, Atomos views the Space Frontier Act of 2018 as the best solution as it places on-orbit authority with the Federal Aviation Administration (FAA), who, as the current authority on commercial launch approval, has heritage in space safety. Additionally, placing leadership of launch approval and in-space operations with one regulatory body helps facilitate a simpler approval process as interagency cooperation, required for nuclear approval, is another process with which the FAA is familiar, as a process has been implemented for previous, non-traditional payload approvals [76]. Atomos wishes to see the approval defined with benchmarks toward which a craft or mission could be engineered. Concrete, mutually agreed safety metrics could help eliminate the burdensome time and cost inherent to previous nuclear approvals.

High-power (hundreds of kilowatts to megawatt-level) fission reactors offer an order of magnitude reduction in mass and transportation cost for the lunar propellant plant power system. Such systems are not under development by NASA. Nevertheless, they can be developed affordably, relying on the heritage of small modular reactors for commercial ground applications, and using existing test facilities. However, government support of private enterprises and revision of regulatory processes are required to allow the commercial development and operation of these systems.



## **Robotic Services**

## Overview<sup>67</sup>

Robotic Services are crucial to any ISRU effort and need to be implemented correctly to ensure resilient, efficient operations. A fundamental ground rule of this study is the assumption of an uncrewed ISRU architecture to avoid the enormous burden of supporting crew and providing the associated crew infrastructure. Two traditional schools of thought bookend the spectrum of robotics in space; fully autonomous and completely teleoperated systems. The optimal system for robotic services on the lunar surface is somewhere in the middle. For ISRU to be feasible in the short-term, robots will have to perform most tasks autonomously, communicate with each other, and work together toward a common objective, while being watched over by teleoperators in case intervention is needed. However, if these robotic systems are designed with requirements that exceed the current state of Artificial Intelligence (AI) technology here on Earth, then lunar ISRU operations will not get off the ground.

One of the most important robotic services that will be conducted on the Moon is prospecting, the identification and mapping of resources. This is further described in the Prospecting section.

The first robotic service is the delivery of the equipment that will be conducted with autonomous robotic landers. There is a multitude of companies working on this portion of the operations with large organizations and smaller startups making significant progress in the development of such technologies.

If the payloads from the lander are not able to dismount by themselves, the next robotic service is going to be an unloading service. To minimize additional equipment, the same robotic system used for unloading equipment from the lander should also be able to load equipment back onto the lander for ascent to orbit. Jet Propulsion Laboratory's (JPL)'s All-Terrain Hex-Limbed Extra-Terrestrial Explorer (ATHLETE)<sup>68</sup> demonstrates a robotic concept that may be applicable to this task.

For the aforementioned techniques of extracting volatiles using surface and subsurface heating, mentioned in Mining Operations, robotic services to assemble/disassemble and move the tent structure would be crucial. Either the robots could be a part of the mining organization or a different robotic services company that partners with the mining organization. Due to the importance of these robotic services, backup solutions should be in place.

Robotic services for transportation of goods and materials are crucial to the ISRU effort as well and are described further in the Transportation section.

Due to the chemical and geometrical properties of lunar regolith, and the harsh environment of space, most systems will need some sort of maintenance to operate for extended periods. For this robotic service, the goal is to minimize mass while providing maintenance for a variety of different systems. To address this challenge, some research and development may be required. Automated operation of the robots can be implemented for many tasks that are simple and well defined. Teleoperation should be limited to complex, infrequent tasks and the resolution of anomalies. Software updates can be introduced over time to increase efficiency of the operation while minimizing risk to other ISRU systems and operations. These types of robots could also have substantial uses here on Earth in the automotive, military, and servicing industries.

---

<sup>67</sup> Section Author: Justin Cyrus, Lunar Outpost, CEO

<sup>68</sup> <https://www-robotics.jpl.nasa.gov/systems/system.cfm?System=11>

## Universal Platform<sup>69</sup>

Such robot platforms are currently in development for terrestrial applications and then for space mineral extraction, processing and construction. OffWorld<sup>70</sup> is a commercial company developing autonomous mining robots for Earth, Moon, Mars and asteroid applications with machine learning capability. The common platform can be configured for multiple species as seen in Figure 28, though not all of these concepts are necessarily needed for every ISRU architecture. The assumption is that large numbers of smaller redundant robots protect against failures by offering many spares. The universal platform with modular attachments coupled with high production rates also drives costs down when compared to one-off highly custom robotic systems.

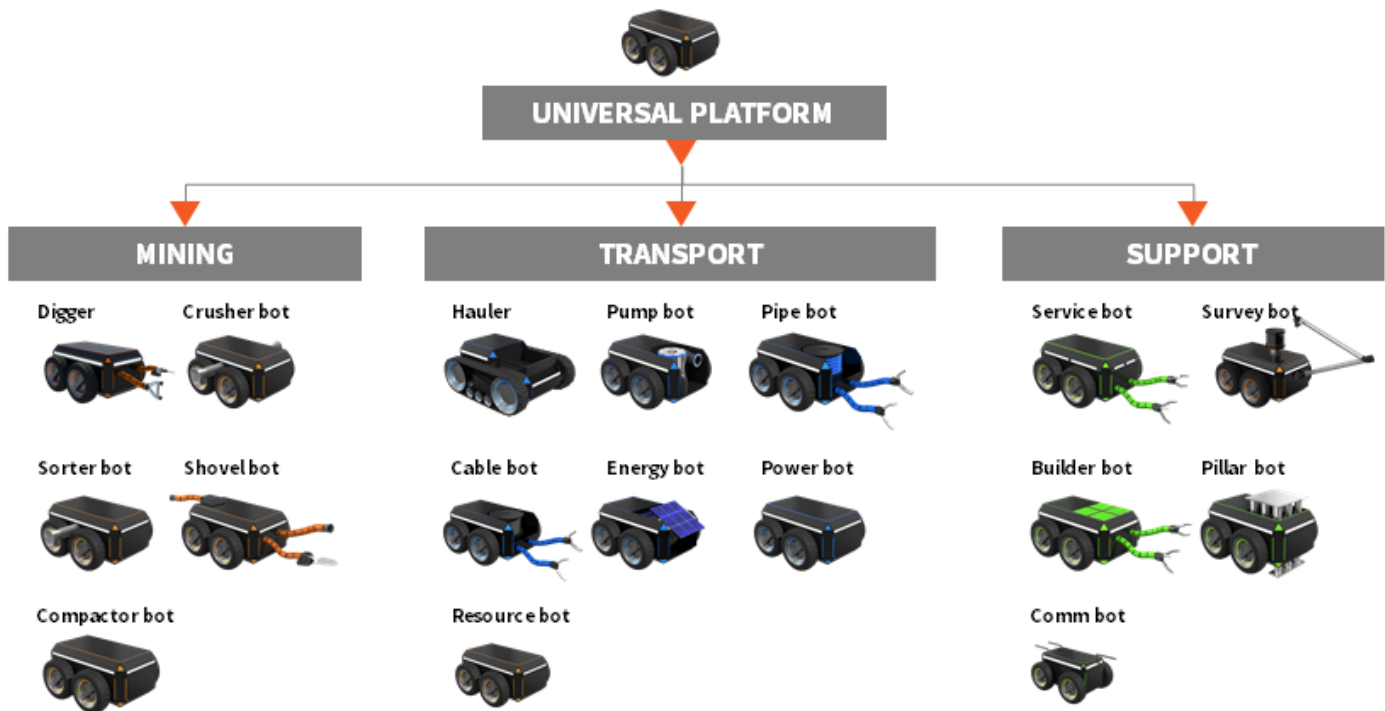


Figure 28: OffWorld Universal Robotic Platform

## Lunar Surface Construction, Maintenance, and Repair<sup>71</sup>

The architecture of the commercial lunar propellant system is being designed without a requirement for human presence. This, of course, means that all phases of the operation—construction, transport, maintenance, repair, extraction, refinement, propellant storage and transfer—must be executed by robotic means. Transport, extraction, refinement and propellant handling are the subjects of other sections. This section will discuss construction, maintenance and repair of the installation by robots.

Complex robotically assembled and maintained systems are a subject of much current progress and development. NASA, for example, is studying<sup>72</sup> how to assemble a very large telescope for exoplanet

<sup>69</sup> Section Author: Jim Keravala, OffWorld Inc, CEO

<sup>70</sup> <https://www.offworld.ai/>

<sup>71</sup> Section Author: Gordon Roesler, Robots in Space LLC, President

<sup>72</sup> <https://exoplanets.nasa.gov/exep/technology/in-space-assembly/>

discovery and astrophysics missions. NASA is also supporting<sup>73, 74 and 75</sup> commercial development of robotic in-space assembly applications. Many of the considerations and capabilities for that in-space project have common elements with the use of robots on the lunar surface. Key questions that are being examined by NASA are:

- What is the right approach to modularizing the system, to achieve the highest performance and reliability at the lowest cost?
- What specific robotic tools and behaviors are required, and what is their technological maturity?
- How does the availability and cost of launch vehicles influence design choices?

Robotic construction is being developed by many research groups around the world. Entire houses are being built using concrete with 3D printing techniques. Lunar regolith could actually be used<sup>76</sup> in a similar way (Figure 29). Although many of the requirements for robotic construction, maintenance and repair will be for specialized components produced on Earth and launched to the lunar site, the use of sintered/printed regolith may prove very effective for structures like landing pads and ground transportation routes. However, in a permanently shadowed crater there is uncertainty in the effects that volatiles may have when mixed with the regolith being sintered.



**Figure 29: Concept for Construction of Blast Shield and Roadway Using Regolith<sup>77</sup>**

<sup>73</sup> <http://madeinspace.us/archinaut/>

<sup>74</sup> [https://www.orbitalatk.com/space-systems/human-space-advanced-systems/mission-extension-services/docs/CIRAS\\_Factsheet.pdf](https://www.orbitalatk.com/space-systems/human-space-advanced-systems/mission-extension-services/docs/CIRAS_Factsheet.pdf)

<sup>75</sup> [https://www.sslmda.com/html/robotics\\_servicing.php](https://www.sslmda.com/html/robotics_servicing.php)

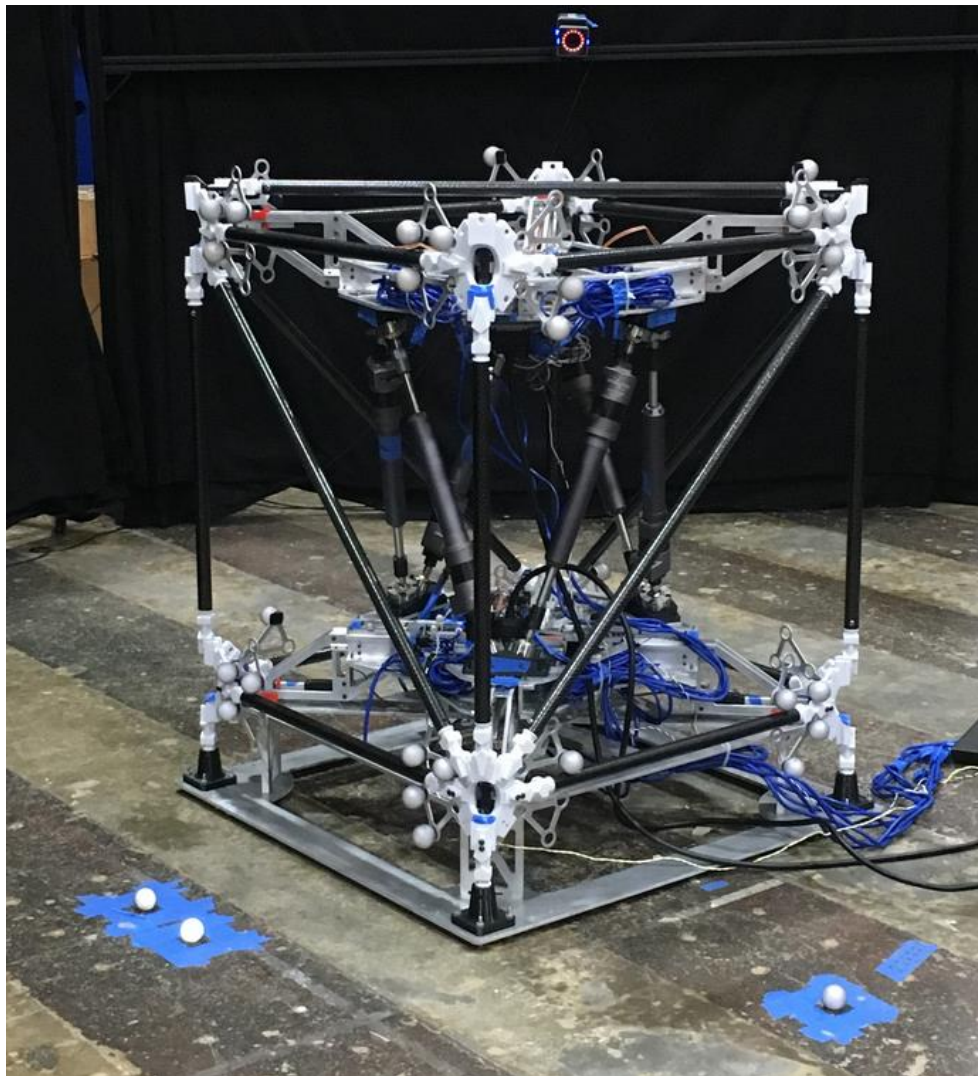
<sup>76</sup> [https://www.nasa.gov/pdf/716069main\\_Khoshnevis\\_2011\\_PhI\\_Contour\\_Crafting.pdf](https://www.nasa.gov/pdf/716069main_Khoshnevis_2011_PhI_Contour_Crafting.pdf)

<sup>77</sup> Image Credit: University of Southern California/Prof. Behrokh Khoshnevis

Robotic assembly operations across the facility will include the following tasks:

- Landing site: minimal construction required, with blast shields being the primary requirement.
- Power plant: installation of solar PV farm, solar reflectors, and/or fission reactors; cable connections between plant components (collectors, control systems, power converters, radiators).
- Extraction facility: erection of the multi-component sublimation facility; integration of plumbing and/or transport for extractant; installation of control equipment.
- Processing and storage facility: emplacement of component equipment and tankage; electrical and fluid connections.

Facility components will be designed in such a way as to make robotic assembly convenient and reliable. Considerable laboratory work has shown the feasibility of robotic in-space assembly, such as for trusses (Figure 30). These concepts build on in-space construction experiments performed by astronauts (Figure 31). Industry has also made large investments in robotic assembly (such as Figure 32).



**Figure 30: NINJAR 2.0, NASA Robotic Space Assembly Experiment<sup>78</sup>**

---

<sup>78</sup> Image Credit: NASA/LaRC





**Figure 31: Assembly of the ACCESS Experiment during STS-61B<sup>79</sup>**



**Figure 32: Robotic Construction of a Trestle Bridge<sup>80</sup>**

---

<sup>79</sup> Image Credit: NASA

<sup>80</sup> Image Credit: Polymer Printers

Some adjustments to robot and component designs will be required when leveraging ongoing work on in-orbit assembly. There are significant differences between robotic assembly in orbit and assembly on the lunar surface within polar craters. The key differences include:

- **Temperature.** Temperatures within the polar craters are much lower than satellites on orbit experience. When satellites experience brief periods in eclipse, electric “survival heaters” are used to maintain components above minimum temperatures. Within the craters, however, shadow and very low temperatures are uninterrupted. Robotic mechanisms must be designed for these conditions. The use of liquid lubricants for joints and bearings, for example, will probably have to be changed to dry surfaces.
- **Abrasion.** The Apollo astronauts brought back samples of lunar regolith—some of which got into their noses, sinuses and lungs. Regolith particles are sharp and abrasive. Moving parts of robots should be protected from dust intrusion.
- **Control.** Robotic assembly schemes for on-orbit operations rely on teleoperation—Earth-based operators sending commands to the robots and monitoring progress with cameras. This requires nearly continuous communications, and proceeds slowly. The lunar facility may experience intermittent communications or limited bandwidth. Thus, a greater percentage of the operations should be automated in order that construction proceed efficiently.
- **Power.** Satellites generally get their power from solar panels. This obviously will not work in the dark lunar craters. Power is discussed in detail in the Power section of this paper. Power can be provided to robotic systems there in four ways:
  - Beaming power from the crater rim or other source
  - Power provided in conductors contained in tracks or electric cable
  - Battery storage in the robots
  - Onboard RTG systems

Each of these has its advantages and disadvantages, but no major technical advances are required to power the robotic construction crew.

One approach to robotic operations is to install a track system. Elevated robotic tracks and rails would alleviate all of the risks described—temperature, abrasion, and control—and incorporate power delivery conductors. An elevated track allows for a more compact robot fuselage design and elimination of an articulated suspension, both of which would conserve heat inside the robot. Moving above the regolith on a track, rather than directly on regolith, would lengthen the robotic lifetime considerably. Control of robot motion would be greatly simplified, as motion is one-dimensional and no obstacles need be avoided once the tracks are in place. Tracks could also have power conductors incorporated to power the robots directly, eliminating the need for power beaming or battery recharging.

Robotic maintenance and repair—both of the facilities and the robots themselves—will greatly benefit if a modular design approach is followed. Module replacement of robotic components should be very similar to facility construction, and hence not require additional techniques to be developed. Highly dexterous operations and complex assembly should be avoided through design modularity. Adequate spare modules should be maintained on the site so that repairs can be made quickly, without serious interruptions to propellant production. Autonomous failure detection and response will be highly beneficial for efficiency and safety.

## In Space

### Grappling Arms<sup>81</sup>

Robotic grapppling arms would be a strong candidate for incorporation into a lunar orbital propellant depot or staging facility. Functions would include grappling and berthing of visiting vehicles, manipulation of on-orbit-replaceable modules, unanticipated repair needs, and external inspection. NASA's concept for the lunar orbiting Gateway currently includes robotics for such purposes. The Canadian Space Agency (CSA), for example, is sponsoring<sup>82</sup> work on the Next Generation Canadarm, or Canadarm 3 (Figure 33). Because the Gateway will only intermittently be occupied by humans, there will also be a need for internal robots, to perform maintenance and repair tasks when no humans are aboard.



**Figure 33: Canadarm 3 on Lunar Orbiting Facility<sup>83</sup>**

The Near Rectilinear Halo Orbit (NRHO) node of the commercial propellant system may or may not be associated with the Gateway, but it will certainly have similar requirements for robotics. Using external robotic systems to capture and gently berth an arriving space object has significant benefits over hard docking: lighter interfaces, lower shock levels, and adaptability. In some cases, the cargo might be transferred from the arriving vehicle to the NRHO facility without the need for berthing at all, but simply by using a robotic manipulator to reach out to the vehicle, grasp the cargo, and transfer it into the NRHO platform. A similar operation is performed by the Space Station Remote Manipulator System (SSRMS) on the ISS with vehicles that have external bays (Figure 34).

<sup>81</sup> Section Author: Gordon Roesler, Robots in Space LLC, President

<sup>82</sup> <http://www.asc-csa.gc.ca/eng/canadarm/ngc.asp>

<sup>83</sup> Image Credit: CSA/MDA



**Figure 34: SSRMS on the ISS Reaching into the Dragon External Cargo Bay<sup>84</sup>**

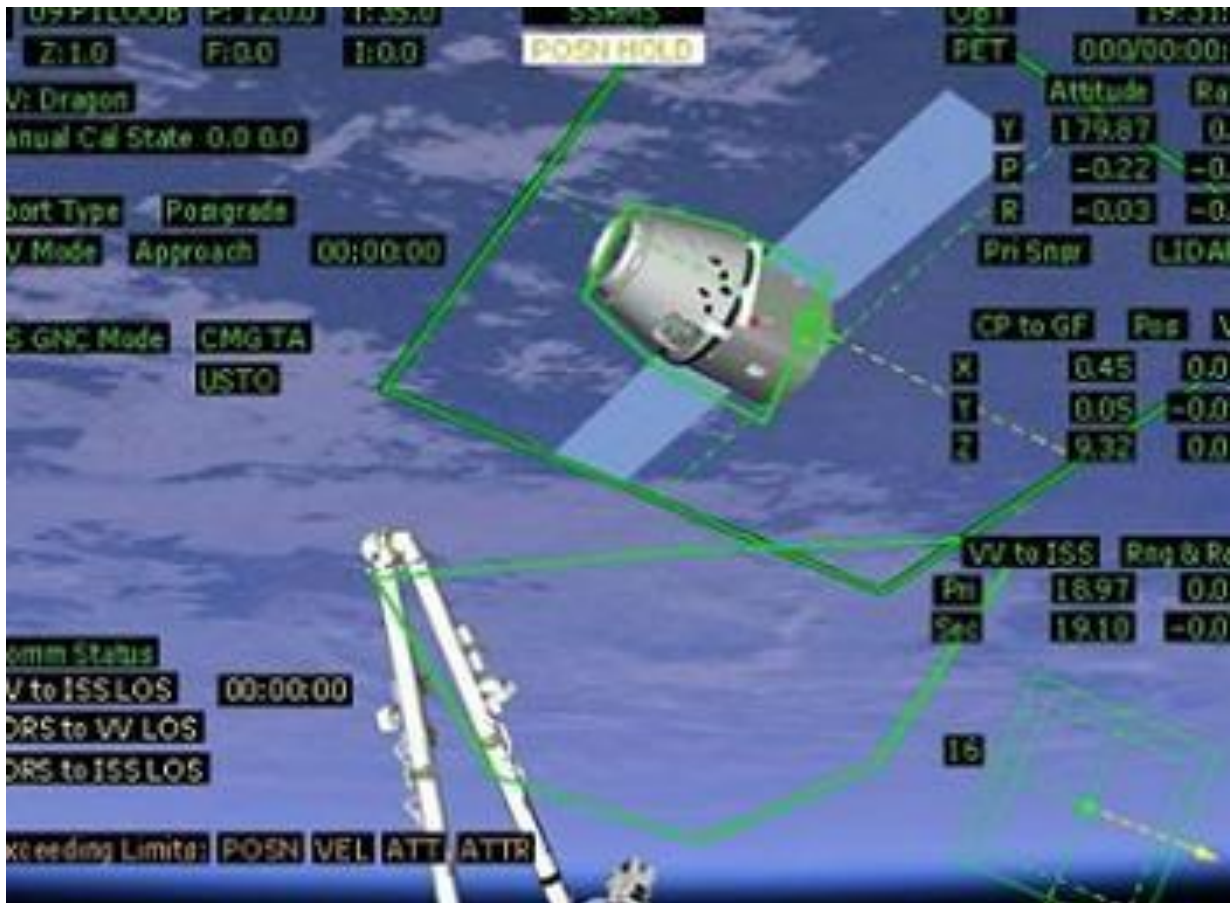
A significant question to be considered in designing the space segment of the propellant architecture is whether it should include an escorting vehicle to assist in the capture of arriving objects. This is both a cost and a safety consideration. Today, there are a number of vehicles capable of rendezvous and docking such as the SpaceX<sup>85</sup> Dragon capsule (Figure 35). The operations that are executed by these vehicles are complex, and many failure modes exist<sup>86</sup>. The vehicles are outfitted with a sophisticated suite of sensors that provide redundant information to the guidance system. Although the use of a reusable lander with rendezvous capability could amortize the cost of automated rendezvous and proximity operations over many ISRU deliveries, it would be very costly if every payload sent to the NRHO station had to carry these capabilities.

---

<sup>84</sup> Image Credit: NASA/SpaceX

<sup>85</sup> <https://www.spacex.com/>

<sup>86</sup> <https://www.nasaspacesflight.com/2012/05/spacexs-dragon-historic-attempt-berth-with-iss/>



**Figure 35: Dragon Capsule on Approach to the ISS**

*The SpaceX Dragon is illustrated on approach to the ISS, with parameters being continuously monitored<sup>87</sup>*

Alternatively, if there was a retrieval tug responsible for all sensing, thrusting, rendezvous and berthing operations, the complexity of equipment on cargo payloads could be greatly reduced, lowering the system-wide cost. A model for this “catcher” vehicle is Defense Advanced Research Projects Agency’s (DARPA)’s Robotic Servicing of Geosynchronous Satellites [77]<sup>88</sup> (RSGS) vehicle (Figure 36). A commercial variant of this model is also being developed by Altius Space Machines and described in the following Rendezvous and Capture section. Using these systems would allow resupply payloads to be “dumb,” as the “catcher” vehicle could remove orbit insertion errors, execute rendezvous and capture, and move the payload to the NRHO facility. In addition, robotic capture systems are inherently multi-purpose. Thus, the escort vehicle could potentially perform other functions such as external repair, assembly, module installation and removal, and close external inspection.

<sup>87</sup> Image Credit: NASA/CSA/SpaceX

<sup>88</sup> <https://spectrum.ieee.org/aerospace/satellites/inside-darpas-mission-to-send-a-repair-robot-to-geosynchronous-orbit>



**Figure 36: Illustration of the DARPA/SSL RSGS Vehicle**

*Shown are the two robotic manipulators, sensing suite, and other hardware<sup>89</sup>*

### **Rendezvous and Capture<sup>90</sup>**

In addition to the above-mentioned traditional in-space robotics approaches, several technologies are being developed for low-cost LEO satellite servicing that may also be directly relevant to rendezvous and capture operations at orbital transportation nodes in this propellant transfer architecture. ISRU only works if we have the capability to rendezvous so we can transfer propellant to customers.

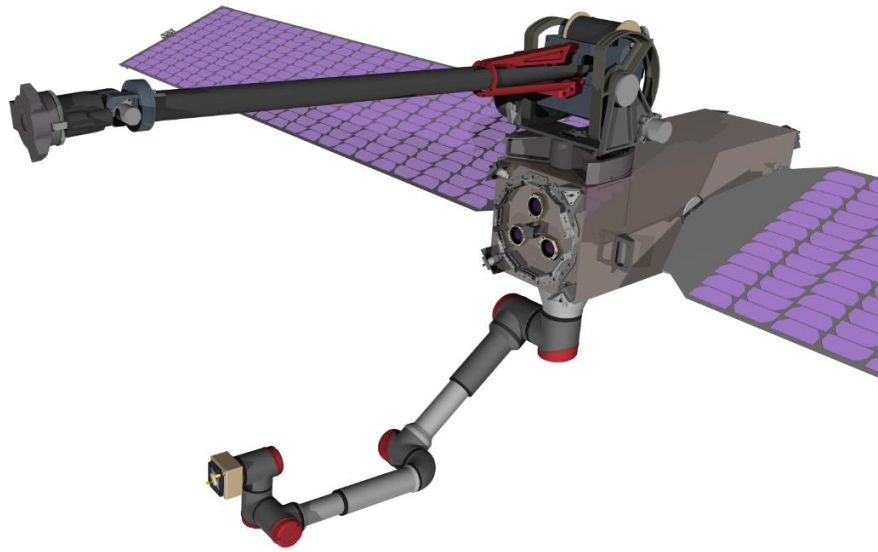
In order to enable low-cost rendezvous and capture of LEO constellation spacecraft, Altius Space Machines<sup>91</sup> has been pioneering the use of boom-assisted magnetic capture technologies that allow for simplified capture of cooperative targets that are equipped with ferrous grapple targets. The use of a 6 Degrees of Freedom (DOF) robotic manipulator that includes a long-reach, extendable/retractable boom element, combined with an electropermanent magnetic capture head, enables capturing spacecraft at a distance, even when the two vehicles have some residual relative velocity. The Electropermanent Magnetic Boom Assisted Rendezvous and Capture (EMBARC) technology (Figure 37) is a simple, low-cost capture solution. Since it is designed to capture objects that have already been outfitted with ferrous grapple targets, it does not require the same sophisticated force-feedback control systems that the Front-end Robotic Enabling Near-term Demonstration (FREND) arms on RSGS use to “grab-on” to non-cooperative legacy Geosynchronous Earth Orbit (GEO) communications satellites that do not already have ferrous grapple targets installed.

---

<sup>89</sup> Image Credit: SSL

<sup>90</sup> Section Author: Jonathan Goff, Altius Space Machines, President and CEO

<sup>91</sup> <http://www.altius-space.com/>



**Figure 37: Bulldog LEO Satellite Servicing Vehicle**  
*Shown with EMBARC boom-assisted magnetic capture system*

Because most spacecraft do not use ferrous materials, Altius has developed a lightweight DogTag™ cooperative grapple fixture (shown below in Figure 38), which includes a ferrous capture surface that is coated with a durable optical coating that provides machine vision recognizable targets to simplify rendezvous and capture operations. Altius is in the process of flight qualifying its DogTag grapple fixture for use on one of the LEO mega constellations currently being developed. With a goal of flying on one of the constellation spacecraft in the 2019 timeframe, a follow-on rendezvous and capture demo using the Bulldog LEO satellite-servicing vehicle will be enabled in the early 2021 timeframe.

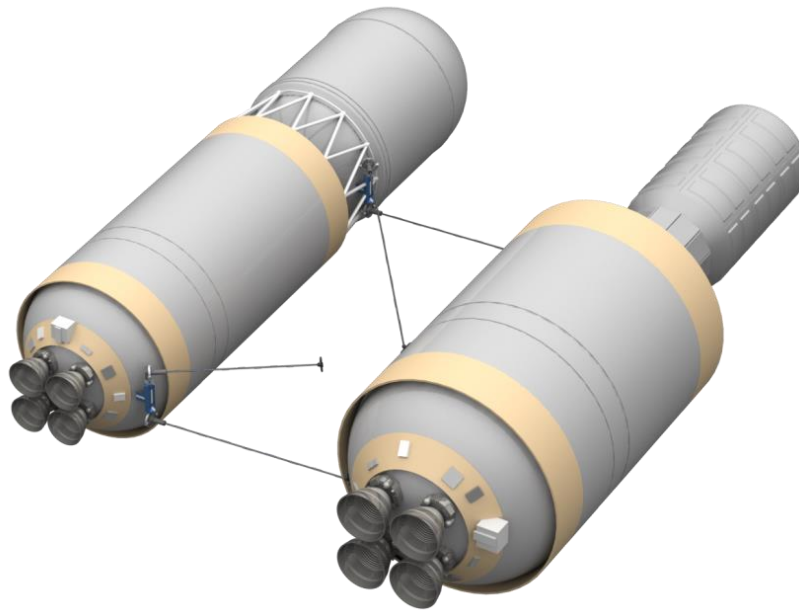


**Figure 38: DogTag™ Cooperative Grappling Fixture**

These capture technologies could be used in the propellant transportation architecture in two ways. One way would be to use the same DogTag grapple interfaces and associated Bulldog servicing vehicles (or scaled-up derivatives) as tugs to capture DogTag equipped tankers and/or cargo vehicles such as reusable second stages or large reusable lunar landers, and maneuver the captured vehicles safely to the propellant transfer facility. Another option would be to use scaled-up versions of the EMBARC Boom-Assisted Magnetic Capture robotics systems to enable Advanced Centaur-class vehicles to rendezvous directly with the propellant transfer facility, as shown below in Figure 39 and Figure 40.



**Figure 39: Artist's Conception of a LEO Propellant Depot for Smallsat Launch Vehicles**  
*Shown using EMBARC boom-assisted magnetic capture technology for direct rendezvous/capture of smallsat launch vehicle upper stages*

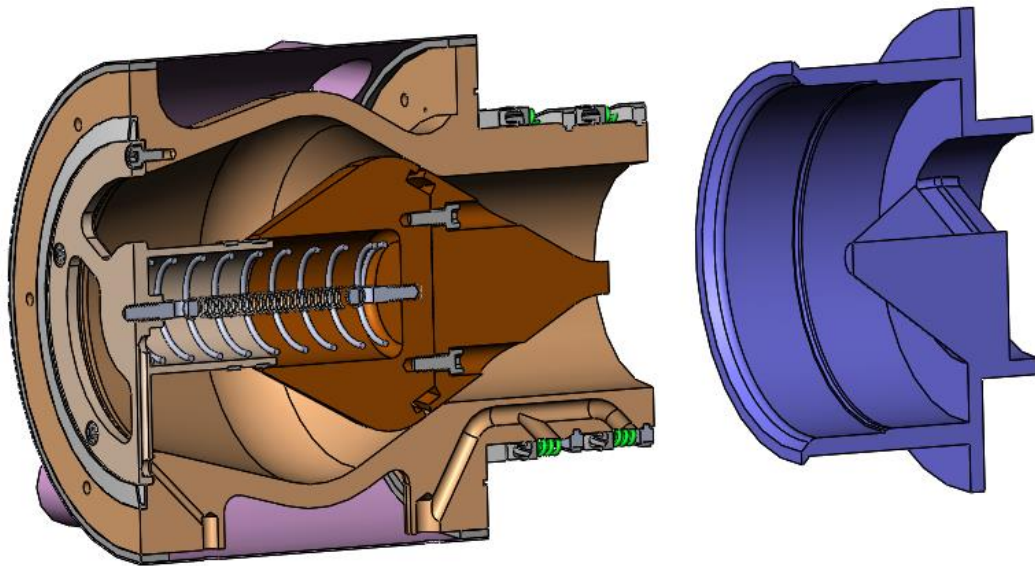


**Figure 40: Illustration of a Soft-Capture Rendezvous with Tanker**  
*Tanker equipped with multiple EMBARC-style boom-assisted magnetic capture arms, rendezvousing with and soft capturing an upper stage and payload for distributed lift in-space refueling*



Using relative navigation sensors and communications systems on the transfer facility, an incoming stage can be tracked. It is then possible to provide maneuver commands to the arriving vehicle allowing it to enter a trajectory that drifts by the facility at a safe distance (10-20m) and low relative velocity (<5cm/s). Once in this state, the stage can be magnetically soft captured by one or more such EMBARC capture systems. Force is gently applied to cancel out relative motion, and then retract, pulling the arriving vehicle close to the propellant transfer facility (within 1-2m) for subsequent refueling. One unique feature of the EMBARC capture system that aids in this type of capture operation is that as the extendable/retractable elements retract, they become more and more stiff in bending, enabling a gentle soft capture at a long distance, followed by more rigid manipulation when retracted close together.

Once capture has been made, one key remaining element is the cryogenic transfer coupling that enables connecting the propellant transfer facility to a visiting tanker to receive or deliver propellants. Because the proposed transfer vehicles will be derived from existing upper stages, Altius is developing a cryogenic transfer coupling (one version of which is shown below in Figure 41) that can serve as an upper stage fill/drain T-0 disconnect coupling. The airborne half of the coupling is being designed so that it can be easily robotically reconnected in-space for subsequent propellant transfer operations—either in zero gravity or on the lunar surface. One of the key unique features of the Altius cryogenic coupling is the ability to “deactivate” the cryogenic seal for low-force insertion/extraction, and then “reactivate” the seal once coupled to form a leak-tight connection. This low-force insertion/extraction characteristic is important for robotic propellant transfer connections. Altius is currently developing this technology under a NASA SBIR Phase II contract, with the goal of flight qualifying a subscale LOX version of this coupling for flight demonstration on a small satellite launch vehicle in the 2019 period, with subsequent development of an upper stage scale LH2-compatible version in follow-on efforts.

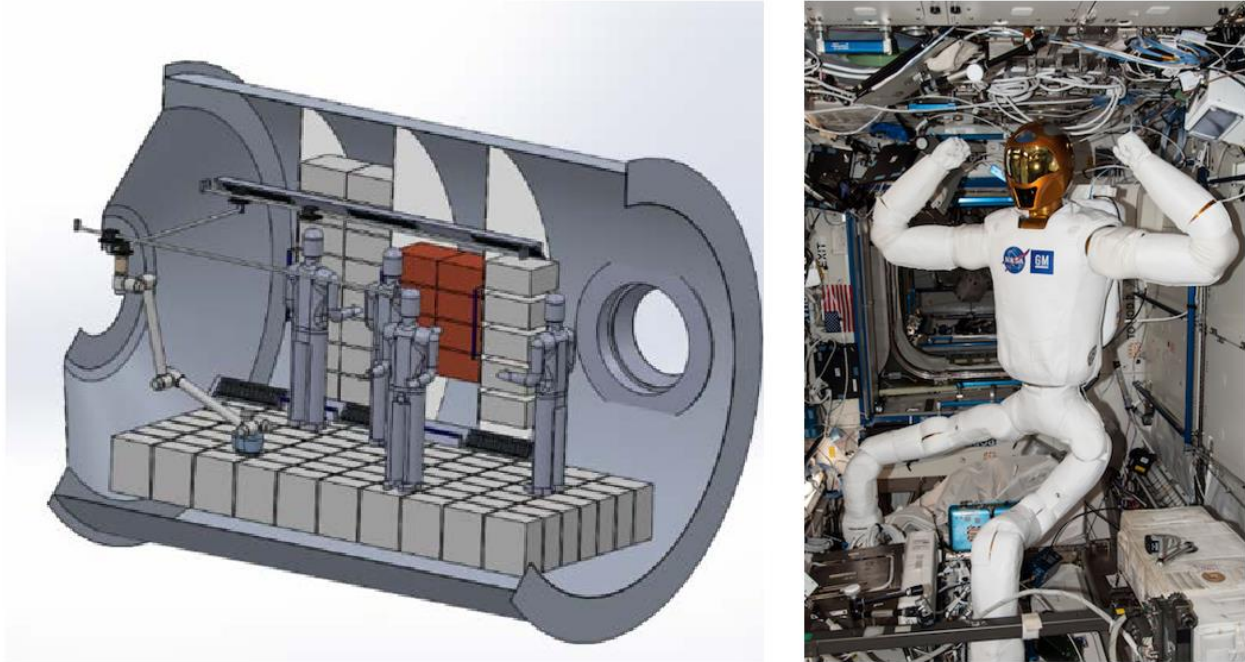


**Figure 41: Cryogenic Transfer Coupling**

*Early conceptual design for a dual-use cryogenic transfer coupling with deactivatable cryogenic sealing sections*

### **“In-Door” Robotics<sup>92</sup>**

In addition to external robotics, the NRHO facility will almost certainly require internal robotic systems for normal operations, maintenance and repair. Two examples of such systems are shown in Figure 42. These could perform various functions including unpacking and stowage of replenishment items, inspection and repair of anomalies, and facility maintenance and cleaning.



**Figure 42: Internal Robotics for Mission Support**

*(left) an illustration of the smaller segment of Canadarm 3 inside the Gateway; (right) Robonaut 2 inside ISS<sup>93</sup>*

---

<sup>92</sup> Section Author: Gordon Roesler, Robots in Space LLC, President

<sup>93</sup> Image Credit: (left) CSA/MDA; (right) NASA/JSC

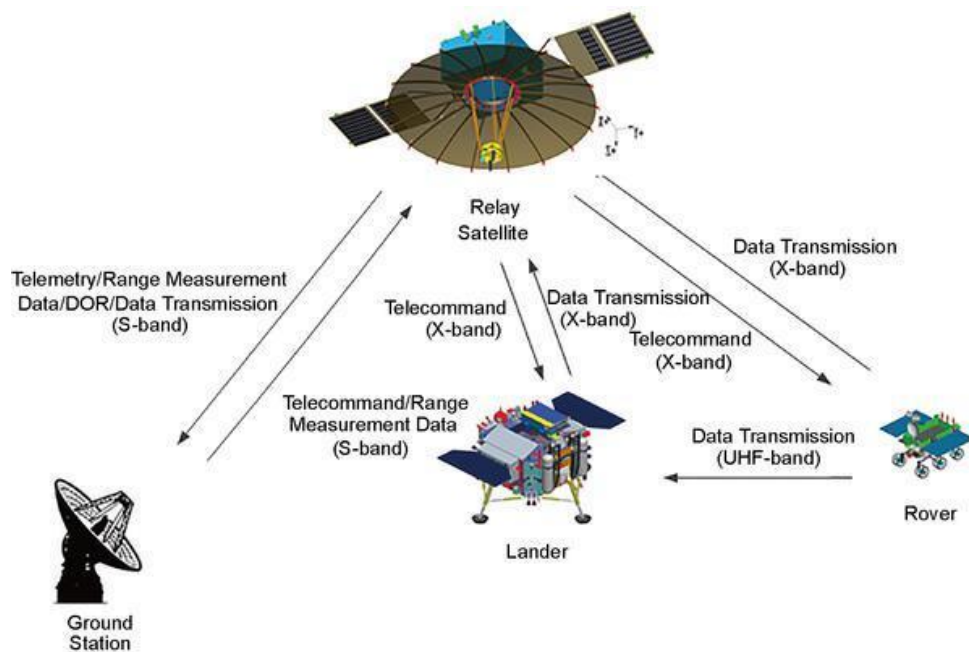


## **Communication and Navigation**

## Overview<sup>94</sup>

The Communication and Navigation (C&N) capability needed to support the lunar propellant production plant differs from the other systems in this paper in that much of the network infrastructure is already in operation or under development. A number of Earth ground stations owned by several national space agencies already provide service to lunar spacecraft. A growing number of Commercial Service Providers (CSP) have announced plans to provide service to future lunar spacecraft. National space agencies with one or more operational Deep Space Antennas (DSA) include NASA, European Space Agency (ESA), Japanese Aerospace Exploration Agency (JAXA), Roskosmos, and Indian Space Research Organization (ISRO). Agencies developing a DSA include United Kingdom Space Agency (UKSA), Korean Aerospace Research Institute (KARI) and United Arab Emirates Space Agency (UAESA). Commercial ground station operators with lunar service ambitions are discussed in the From Earth section below.

These Earth-based capabilities only provide service to the nearside of the Moon. To provide coverage of the lunar far side and shadowed Polar Regions, lunar relays will be required. There is currently only one lunar relay in place, China's Chang'e-4 *Queqiao*, which was launched on May 20, 2018 (Figure 43). Three other agencies plan to launch spacecraft with lunar relay capability.



**Figure 43: Queqiao, the Chang'e 4 Relay<sup>95</sup>**

*Chinese relay satellite to support the Chang'e 4 rover planned to land on the far site on the Moon in late 2018. The 425 kg relay satellite is three-axis stabilized with a 130 N hydrazine propulsion system and carries a deployable 4.2 m dish antenna for the relay. It provides four 256 kbps X-band links between itself and the lander/rover and one 2 MBps S-band link towards Earth.*

In addition, an international organization is coordinating among the international space agencies to define a Lunar Communications Architecture (LCA). The Interagency Operations Advisory Group (IOAG) was founded in 1999 to act “as the international focal point for fostering and leading interoperable space communications and navigation matters for cross support of spaceflight missions...A specific IOAG goal is the achievement of full interoperability among member space agencies.”<sup>96</sup> Members include Italian Space

<sup>94</sup> Section Author: Jim Schier, NASA HQ, SCAN Chief Architect

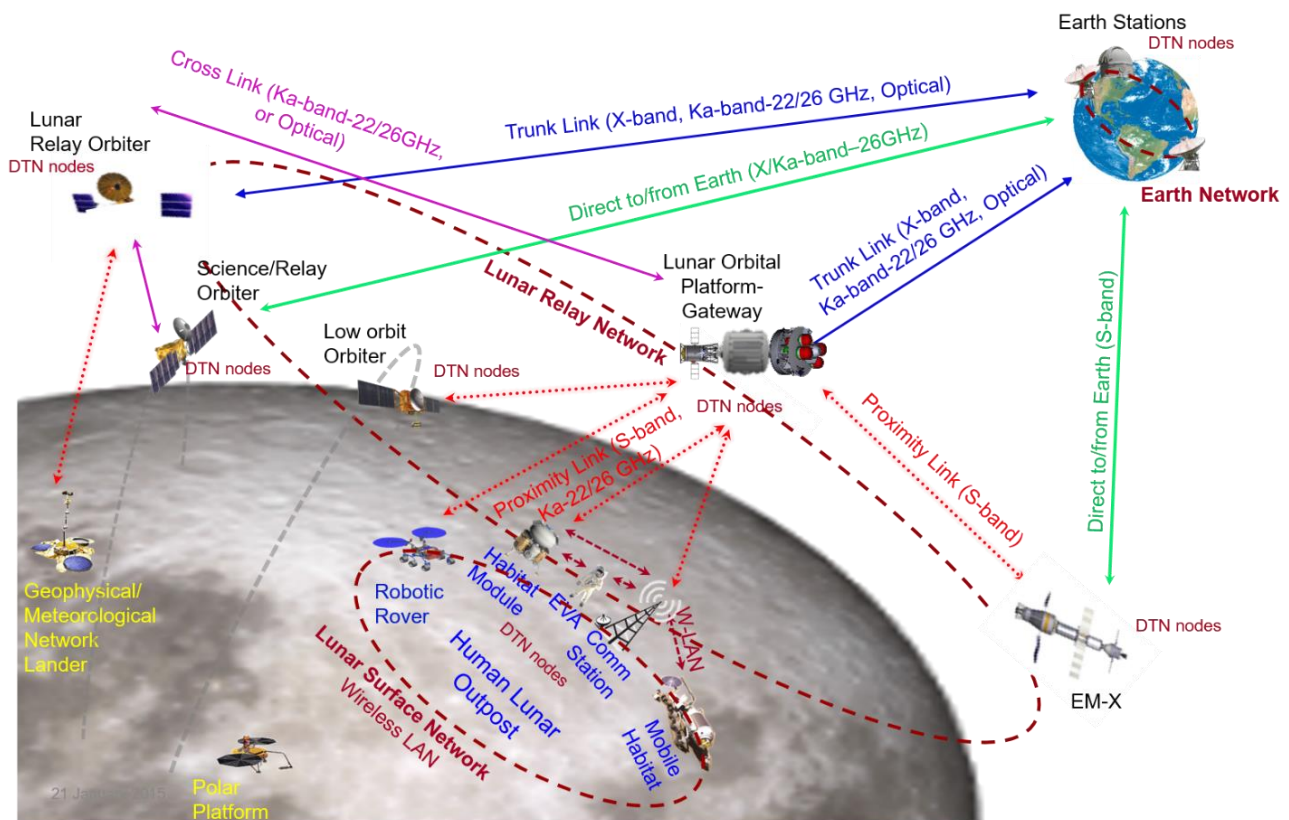
<sup>95</sup> Ref: Gunter's Space Page, [http://space.skyrocket.de/doc\\_sdat/change-4-relay.htm](http://space.skyrocket.de/doc_sdat/change-4-relay.htm)

<sup>96</sup> IOAG Terms Of Reference, Issue 4.0, February 2014, <https://www.ioag.org/default.aspx>

Agency (ASI) (Italy), French Space Agency (CNES) (France), CSA (Canada), German Aerospace Center (DLR) (Germany), ESA (Europe), JAXA (Japan), and NASA (US) with China National Space Administration (CNSA) (China), KARI (S. Korea), Roskosmos (Russia), South African National Space Agency (SANSA) (S. Africa), UKSA (United Kingdom), and UAESA (United Arab Emirates) as observer agencies. The IOAG coordinates activities with the Consultative Committee for Space Data Systems (CCSDS) (develops international space C&N standards), the Space Frequency Coordination Group (SFCG) (coordinates spectrum allocation and usage), the International Space Exploration Coordination Group (ISECG) (performs a role similar to IOAG for other aspects of international space mission coordination), and the International Committee on Global Navigation Satellite Systems (ICG, GNSS) (is a UN committee that coordinates interoperability across the many national navigation and positioning systems).

The IOAG expects to reach agreement by late 2018 on the LCA, which addresses lunar spectrum, communication protocols, position, Navigation and Timing (PNT) protocols, and conventions on C&N operation. The LCA intended to be applicable to all international space agency lunar missions. Figure 44 describes the LCA that features three primary types of networks:

- Earth Networks representing the ground stations that support the lunar missions
- Lunar Relay Network(s) representing the lunar orbiting spacecraft that support the lunar missions in other lunar orbits and on the lunar surface
- Lunar Surface Network(s) representing the surface stations that provide wireless (RF or laser) communications to fixed and mobile surface systems.



**Figure 44: IOAG Lunar Communications Architecture<sup>97</sup>**

<sup>97</sup> draft, June 27, 2018

Each of these types of networks represents a combination of capabilities provided by several international space agencies, all capable of interoperating much as terrestrial telecommunications companies provide seamless global telephone, television, and internet services. Services shown in Table 7 are based on Delay/Disruption Tolerant Networking (DTN) for space internetworking which is similar to, and compatible with, Internet Protocol (IP) but capable of dealing with longer delays and the frequent loss of connectivity that occur with space links. DTN provides guaranteed data delivery by using store-and-forward capability built into the network service.

The architecture is based on modularity, layering, open international standards-based interfaces, and automation. Modularity dictates that the system be designed using a small number of reusable components that can provide increasing capacity merely by adding more components. Like terrestrial computer networks, the architecture can grow by flying additional relays and surface terminals.

**Table 7: Data and PNT Services Provided in the Lunar Communications Architecture**

Service Type	Description
<b>Lunar Relay services:</b>	
Space Internetworking	Provides routed, assured, secure delivery of mission data using DTN suite
Network Time	Provides network-wide time using a Network Time Protocol (NTP)
In-situ Tracking	<b>Ranging:</b> Measures the time delay between the user vehicle and the relay orbiter using RF or optical transmission (convertible to distance)
	<b>Doppler:</b> Measures and time tags the phase of the transmitted forward carrier and/or the received return carrier at the relay orbiter
	<b>Antenna Pointing Angle:</b> Measures the pointing angle of the relay RF antenna or optical terminal as it tracks the user vehicle
In-situ Navigation	<b>Positioning:</b> Determines the location of the user vehicle, on lunar surface or in lunar orbit, based on available tracking data types
<b>Application Layer Services enabled by Relay Services:</b>	
End-to-end file delivery	Transfers files bi-directionally between a user vehicle and ground system or between two user vehicles
End-to-end messaging	Transfers messages bi-directionally between a user vehicle and ground system or between two user vehicles
End-to-end space packet	Transfers CCSDS space packets from a user vehicle to ground system or between two user vehicles

An open question is the degree to which commercial lunar missions will be encouraged to contribute to the LCA or to comply with its provisions. The recommendation in this paper is for commercial lunar C&N providers to utilize the LCA, where possible, and work with the international space agencies to extend it, where necessary, to achieve the capabilities needed for the lunar propellant production plant.

### Lunar Surface<sup>98</sup>

Communications on the lunar surface rely on a combination of wired and wireless capabilities. As shown in Figure 45, the lunar surface network includes one or more Lunar Communications Terminals (LCT) (highlighted in yellow) that act as local multiplexers/demultiplexers/routers connecting many surface elements and then relays data to/from the overhead Lunar Relay Satellites (LRS) or directly to the Earth Network when it is visible. The Local Area Network (LAN) can employ Ethernet or equivalent

<sup>98</sup> Section Author: Jim Schier, NASA HQ, SCAN Chief Architect



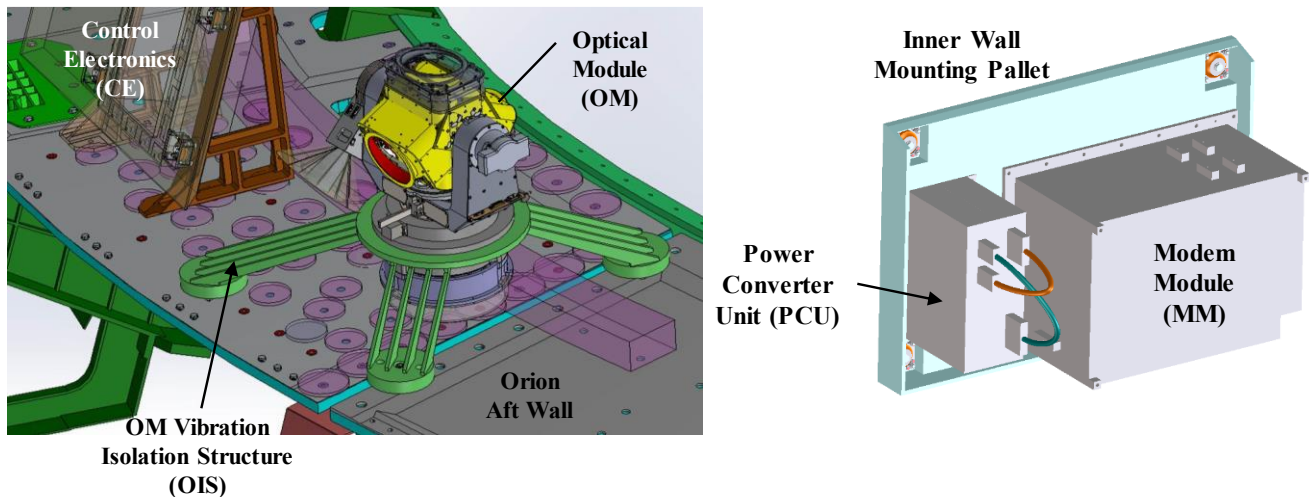
**Table 8: Current and Planned Lunar Relay Capabilities**

Relay Orbiter	Launch Year	Agency	Earth communication assets	Orbit type	Orbital parameters	Coverage performance	Frequencies & Maximum Data Rates				Space data link protocol	Space network protocol	Relay Services
							Earth to Relay	Relay to Earth	Relay to Lunar surface or	Lunar surface or orbital			
Lunar Orbital Platform-Gateway (LOP-G)	2022	NASA	DSN, NEN, ESTRACK	Near-Rectilinear Halo Orbit (NRHO) and Distant Retrograde Orbit (DRO)	<ul style="list-style-type: none"> <li>NRHO Orbital period: ~6.25 days. Elliptical polar 4,000 x 70,000 Km adjustable orbit. Max range from S. Pole: 70,000 Km. Max velocity 0.85 Km/s.</li> <li>DRO Orbital period: ~14 days. Distance from moon ~60,000 km.</li> </ul>	<ul style="list-style-type: none"> <li>NRHO: Continuous coverage of S.Pole for 144.6 hours with a gap of 5.4 hours</li> <li>DRO: 3-4 days availability/14 day orbit</li> </ul>	<ul style="list-style-type: none"> <li>X-band: 10 Msps;</li> <li>Ka-band: at least 10 Mbps (may be 30 Mbps);</li> <li>Optical: rate TBD</li> </ul>	<ul style="list-style-type: none"> <li>X-band: 4 Msps;</li> <li>Ka-Band: at least 100 Mbps (may be 300 Mbps)</li> <li>Optical: rate TBD</li> </ul>	<ul style="list-style-type: none"> <li>S-band: 10 Msps;</li> <li>Ka-band: 10 Mbps;</li> <li>Optical: rate TBD</li> </ul>	<ul style="list-style-type: none"> <li>S-band: 4 Msps;</li> <li>Ka-band: 100 Mbps;</li> <li>Optical: rate TBD</li> </ul>	<ul style="list-style-type: none"> <li>All links: AOS (USLP when CCSDS Blue Book is available)</li> </ul>	DTN BP/LTP	<ul style="list-style-type: none"> <li>Space internetworking service,</li> <li>In-situ tracking service,</li> <li>In-situ navigation service (TBC).</li> </ul>
Lunar Communications Pathfinder	2022	Goonhilly, UK Space	Goonhilly, ESTRACK	12-hour "Frozen" Orbit	<ul style="list-style-type: none"> <li>SMA = 6142.4 Km.</li> <li>Eccentricity = 0.59999.</li> <li>Inclination = 57.7 deg.</li> <li>Perilune = 90 deg.</li> <li>Elliptical polar 500 x 9,900 Km orbit.</li> <li>Max range from S. Pole: ~9,900 Km.</li> <li>Max velocity 0.68 Km/s.</li> </ul>	<ul style="list-style-type: none"> <li>Orbital period ave. 12 hours.</li> <li>Continuous coverage of S.Pole for 9.13 hours with a gap of 2.87 hours.</li> </ul>	<ul style="list-style-type: none"> <li>X-band: 16 Kbps</li> </ul>	<ul style="list-style-type: none"> <li>X-band: 3 Mbps</li> </ul>	<ul style="list-style-type: none"> <li>S-band and/or UHF: 64 Kbps</li> </ul>	<ul style="list-style-type: none"> <li>S-band and/or UHF: 2 Mbps</li> </ul>	<ul style="list-style-type: none"> <li>Relay-User links: USLP and/or Proximity-1;</li> <li>Earth-Relay links: USLP and/or TC/TM</li> </ul>	DTN BP/LTP	<ul style="list-style-type: none"> <li>Space internetworking service,</li> <li>In-situ tracking service,</li> <li>In-situ navigation service (TBC).</li> </ul>
Chang'e-4 Queqiao	2018	CNSA	Kashgar, Jiamusi, Miyun, & Neuquen (Argentina)	Assumption 1: Earth-Moon L2 Lissajous Orbit	<ul style="list-style-type: none"> <li>74-day Lissajous orbit at Earth-Moon L2 (9 loops).</li> <li>Max range from S. Pole: 90,000 Km.</li> </ul>	<ul style="list-style-type: none"> <li>9 contacts/74 days. Average contact duration at S. Pole is 170 hours.</li> <li>Average Communication gaps at S. Pole is 31 hours.</li> </ul>	<ul style="list-style-type: none"> <li>S-band: 1 Kbps</li> </ul>	<ul style="list-style-type: none"> <li>S-band: 2 Mbps</li> </ul>	<ul style="list-style-type: none"> <li>X-band: 1 Kbps</li> </ul>	<ul style="list-style-type: none"> <li>X-band: 4x256 Kbps</li> </ul>	<ul style="list-style-type: none"> <li>Relay-User links: Proximity-1 (TBC);</li> <li>Earth-Relay links: TC/TM</li> </ul>	None (TBC)	<ul style="list-style-type: none"> <li>Store-&amp;-forward space packet service</li> </ul>
				Assumption 2: Earth-Moon L2 Halo Orbit	<ul style="list-style-type: none"> <li>14-day Halo orbit at Earth-Moon L2.</li> <li>Max range from S. Pole: 84,000 Km.</li> </ul>	<ul style="list-style-type: none"> <li>At S. Pole, 1 contact/14 days with duration of 224 hours, followed by a gap of 102 hours.</li> </ul>							
Chandrayaan-2 Orbiter	2019	ISRO	IDSN, DSN	Lunar Circular Orbiter	<ul style="list-style-type: none"> <li>100 x 100 Km circular orbit.</li> <li>Range from S. Pole: 100 Km.</li> </ul>	<ul style="list-style-type: none"> <li>Orbital period: 2 hours</li> </ul>	<ul style="list-style-type: none"> <li>S-band: 125 bps</li> </ul>	<ul style="list-style-type: none"> <li>S-band: 4 Kbps;</li> <li>X-band: 8.4 Mbps (payload data)</li> </ul>	<ul style="list-style-type: none"> <li>S-band: 2 Kbps</li> </ul>	<ul style="list-style-type: none"> <li>S-band: 2 Kbps;</li> <li>X-band: 256 Kbps (payload data)</li> </ul>	<ul style="list-style-type: none"> <li>Relay-User links: Proximity-1 (TBC);</li> <li>Earth-Relay links: TC/TM</li> </ul>	None	<ul style="list-style-type: none"> <li>Store-&amp;-forward space packet service</li> </ul>



If these spacecraft are not present, then the lunar propellant production plant cost will have to reflect the additional NRC of developing a LRS. A decision will be required to determine whether to design the LRS with just sufficient performance to meet the lunar propellant production plant’s needs or whether to establish a partnership with a CSP who can invest in the LRS as a commercial entity providing communications services to other customers as well as the lunar propellant production plant. If new relays were required, the 12-hour frozen orbit recommended by the IOAG (and used by the Lunar Communications Pathfinder) would also work well for the lunar propellant production plant. Two LRS in this orbit, phased 180° apart, would provide continuous coverage of one lunar polar region. The two relays would provide redundancy and the ability to continue operations with reduced coverage if one relay fails.

NASA began testing lunar laser communications with the Lunar Laser Communications Demonstration (LLCD) flown on the Lunar Atmosphere and Dust Environment Explorer (LADEE) in 2013. It proved the ability to send 20 Mbps to the Moon and receive 622 Mbps from the Moon. The next step is to provide a second-generation payload on the Orion crew vehicle on Exploration Mission 2 (EM-2) in 2023 followed by a payload on the Gateway in 2025-26. Both of these demonstrations will provide high rate Earth-to-Moon links at 20 Mbps and Moon-to-Earth links at ~1 Gbps requiring significantly less Size, Weight and Power (SWaP) than a comparable Ka-band system. NASA is in the process of commercializing the laser communications technology so that subsequent payloads will be available on the commercial market. Figure 46 shows the design of the Optical to Orion (O2O) payload that will be installed on the Orion Adapter Module including its own vibration compensation module to achieve the extremely precise pointing needed by the laser.



**Figure 46: Laser Communications Payload design for Orion crew vehicle on EM-2**

**From Earth<sup>100</sup>**

All operations are executed in a highly automated manner, thereby minimizing labor requirements and maximizing reliability. All ground interfaces are also expected to reflect well-established standards, thereby benefiting from ongoing industry developments.

Dividing the network into layers encapsulates network functions and separates implementation of each layer at standard interface boundaries allowing the evolution of each layer independently while minimizing the impact of changes on adjacent layers. The LRS and LCT are the only portions of the architecture that require entirely new systems to be developed. These new systems will be “born flexible” by incorporating

<sup>100</sup> Section Author: Jim Schier, NASA HQ, SCAN Chief Architect

concepts from terrestrial telecommunications and the Internet. The capacity of the resulting architecture can be increased or decreased by adding or subtracting relays and other assets to meet individual and cumulative mission needs and available budget. Finally, layering and standardization provide a framework for incrementally inserting new technologies to meet evolving and expanding lunar exploration and science objectives.

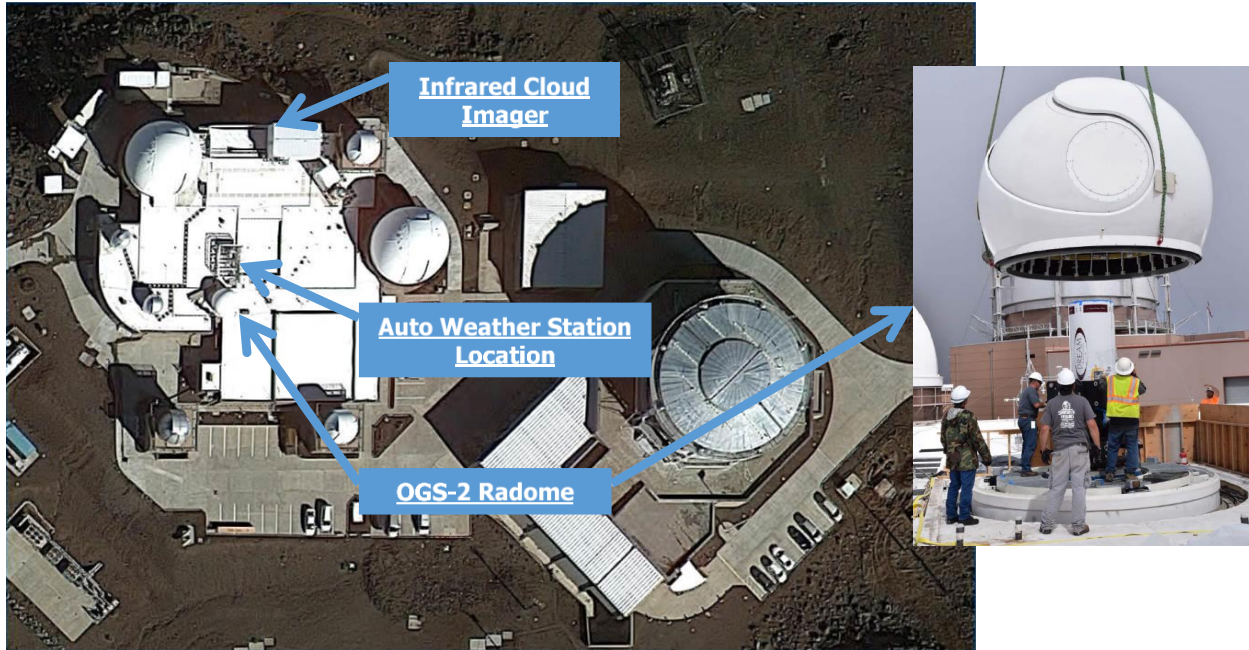
Table 9 shows that there are several commercial networks under development that plan to be capable of providing communications services to lunar systems. NASA’s Deep Space Network (DSN) and Near Earth Network (NEN) are included for comparison purposes but the focus is on availability of commercial solutions. NASA will begin testing lunar laser communications with a technology demonstration on the Orion crew vehicle on EM-2 in 2023 followed by a payload on the Gateway in 2025-26. Other international space agency capabilities include ESA's tracking station network (ESTRACK) which is a global system of ground stations providing links between satellites and the European Space Operations Centre (ESOC) in Darmstadt, Germany. ESTRACK has three 35 m-diameter DSA in New Norcia, Australia, Cebreros, Spain, and Malargüe, Argentina.

**Table 9: Current and Planned Lunar C&N Networks**

Network	Country of Incorporation	Description of Capabilities Including Lunar Service
NASA Deep Space Network	US (government)	3 RF ground stations at Goldstone, California, Canberra, Australia, and Madrid, Spain providing nearly complete, continuous solar system coverage. Capable of <b>operational lunar service at 150 Mbps</b> .
NASA Near Earth Network	US (government)	15 RF ground stations globally distributed including contracted support from SSC and KSAT. <b>World’s highest data rate operational lunar service (125 Mbps)</b> via NASA-owned 18m antenna.
Swedish Space Corp. (SSC)	Sweden	Provides ground stations at 10 SSC sites plus 8 sites by collaborative partners. Mission services cover Geostationary Transfer Orbit Service, lunar excursion and Deep Space escape orbits. <b>No lunar service.</b> <a href="https://www.sscspace.com/services/#satellite_ground_communication">https://www.sscspace.com/services/#satellite_ground_communication</a>
SSC Space US, Inc.	US registered subsidiary of SSC	4 RF ground stations globally distributed; operational lunar service to NASA LRO. Prior to SSC purchase, the former <b>Universal Space Network offered a 50% discount for services to entrants for the Google Lunar X Prize.</b> <a href="https://www.sscspace.com/about-ssc/subsidiaries/">https://www.sscspace.com/about-ssc/subsidiaries/</a>
Audacy	US	The proposed Audacy network consists of 3 relay satellites in Medium Earth Orbit (MEO), paired initially with two ground facilities. The spacecraft locations allow for serviceable link distances to users in LEO. Deep space users will be addressed using Audacy ground assets. Ground stations are planned for San Francisco, Singapore, and Luxembourg. <b>Plans announced for lunar services.</b> Each ground station also directly communicates with spacecraft anywhere in Earth-Moon space. <b>Gateways are advertised to be large enough to achieve multiple Mbps at lunar distance</b> , yet fast enough to track objects in LEO. No operational service provided to date. <a href="https://audacy.space/architecture">https://audacy.space/architecture</a>
Laser Light Companies	US	Laser Light will fully deploy an All-Optical Hybrid Global Communications Network called HALO (High Articulation Laser Optics™) by FY2020. The all-optical MEO satellite constellation is planned to connect with optical terminals at 100 initial customer locations around the world using industry standard service level agreements with a full network capacity of +33 Tbps and 72-customer service links of 200 Gbps bi-directionally. The network is not operational yet. <b>No lunar service.</b> <a href="https://www.laserlightcomms.com/">https://www.laserlightcomms.com/</a>

Network	Country of Incorporation	Description of Capabilities Including Lunar Service
Atlas Space Operations	US	<p>Currently has two operational ground sites (Ghana, New Zealand); 13 added sites planned by 2019. <b>The ATLAS Interplanetary Satellite Communications Network (ISCN) enabled by ATLAS LINKS™ Electronically Steered Array plans to be the first commercially available deep space communications network.</b> Using proprietary phased array technology, the ISCN can detect and track radio signals of a deep space mission up to 30 million km away (18 million miles). Transmits and receives in UHF, S, and X-Bands, with Ka-band planned. ATLAS plans to begin offering a globally accessible Optical Communications capability in 2019 by integrating into the Laser Light Communications HALO free space optical constellation (see Laser Light Companies above) while adding relay capability from the Moon. ATLAS will provide customers with access to an optical payload to access HALO at downlink speeds of 10 Gbps.</p> <p><b>ATLAS has formed a partnership with Astrobotic to provide lunar and deep space communications infrastructure in space.</b> The first Astrobotic mission to carry an ATLAS optical terminal is planned for 2019.</p> <p><a href="http://atlasground.com/">http://atlasground.com/</a></p>
RBC Signals	US	<p>The RBC Signals Global Ground Station Network aggregates the unused capacity of existing satellite ground stations around the world. The RBC Signals network currently supports VHF, UHF, S-band, and X-band services. Ka-band antennas are expected to come online. <b>All assets are ground based so PSR applications will be limited.</b></p> <p><a href="http://rbcsignals.com/">http://rbcsignals.com/</a></p>
Morehead State University (MSU)	US academic institution	<p>The 21m Space Tracking Antenna at MSU provides satellite tracking, telemetry and control services to other universities, private aerospace clients and government agencies. The system serves as an Earth station for satellite mission support and acts as a test bed for advanced RF systems. The system is capable of tracking fast moving, low-transmitting power small satellites in low Earth orbit as well as satellites at geostationary, <b>lunar</b> and potentially Earth-Sun Lagrangian orbits. The system has been upgraded in cooperation with JPL's DSN to provide capabilities similar to a DSN antenna but with lower performance than a DSN 34m antenna.</p> <p><a href="http://www.moreheadstate.edu/College-of-Science/Earth-and-Space-Sciences/Space-Science-Center/Satellite-Tracking,-Telemetry-Control-Services">http://www.moreheadstate.edu/College-of-Science/Earth-and-Space-Sciences/Space-Science-Center/Satellite-Tracking,-Telemetry-Control-Services</a></p> <p><a href="http://www.moreheadstate.edu/College-of-Science/Earth-and-Space-Sciences/Space-Science-Center/Laboratories-Facilities/Space-Tracking-Antennas">http://www.moreheadstate.edu/College-of-Science/Earth-and-Space-Sciences/Space-Science-Center/Laboratories-Facilities/Space-Tracking-Antennas</a></p>
Goonhilly	England	<p>23 antennas at 1 site in Cornwall, England; <b>lunar services advertised and upgrades to existing 32m and 30m antennas in progress.</b> Sponsored by ESA and UKSA. Partnerships announced with Surrey Satellite and Astrobotic to provide small payload transportation to the lunar surface, mission operations center, and <b>communications to lunar surface payloads.</b> No lunar service provided to date.</p> <p><a href="http://www.goonhilly.org/satellite-communication-teleport/deep-space-communications">http://www.goonhilly.org/satellite-communication-teleport/deep-space-communications</a></p> <p><a href="http://www.goonhilly.org/lunar">http://www.goonhilly.org/lunar</a></p>

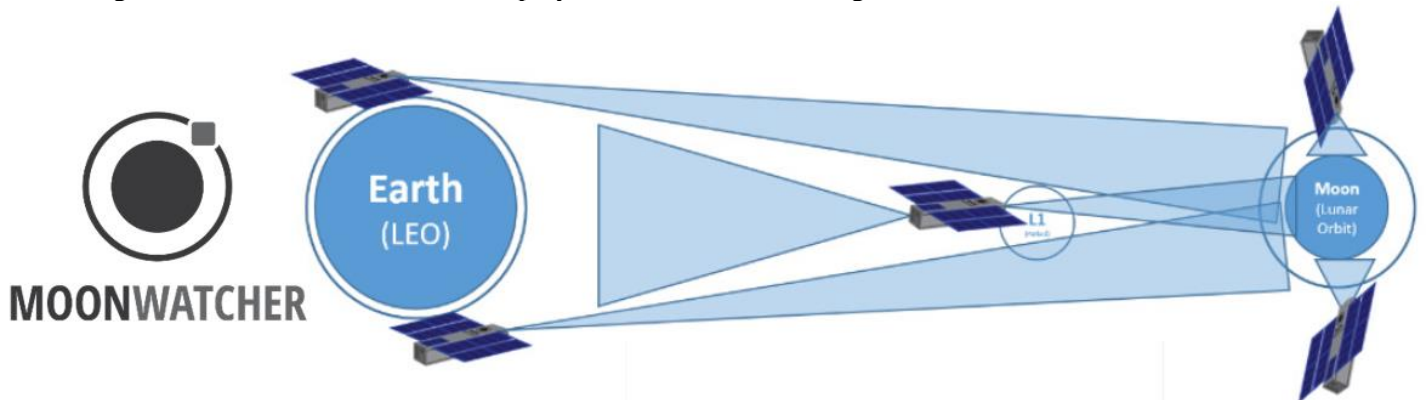
NASA's initial Optical Ground Stations will be located at Table Mountain, CA (JPL facility) and Maui, HI. Figure 47 shows Optical Ground Station 2 (OGS-2) with an array of four telescopes being installed on the Air Force Maui Optical Station (AMOS). These stations will be tested first with the Laser Communications Relay Demonstration (LCRD), an experimental optical payload being flown on the Air Force's Space Technology Program Satellite 6 (STPSat-6) in 2019. Optical ground technology uses modified commercially available telescopes and private utilization is producing very low cost ground terminals.



**Figure 47: Optical Ground Station 2 installation on roof of Air Force Maui Optical Station**

### **Moon Navigational Services<sup>101</sup>**

In addition to international government and private C&N systems for lunar and cislunar activities, Lunar Station Corporation (LSC)<sup>102</sup> is developing Moon navigational services for lunar activities. LSC is building their services for organizations pursuing scientific and business opportunities on the Moon. Solutions will provide surveying, navigating, and prospecting decision support from mission planning through mission execution with a constellation of remote sensing small satellites called MoonWatcher. Figure 48 shows the constellation deployed for maximum coverage of the Moon's surface.



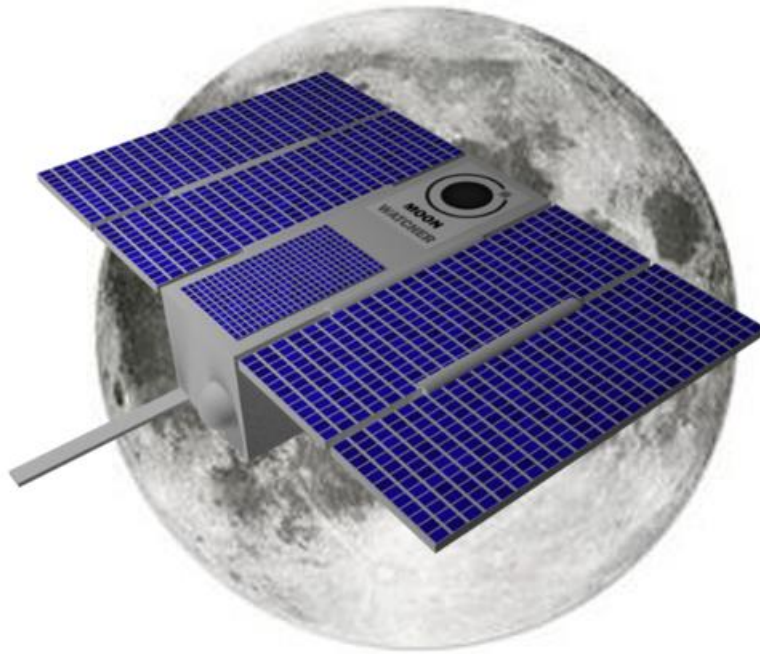
**Figure 48: Lunar Station Corporation's MoonWatcher Constellation**

The initial MoonWatcher Satellites will be remote sensing CubeSats (3U) payloads deployed in LEO. Each of the MoonWatchers will have slightly differing capabilities to create optimally spread spectrum coverage of the Moon. The benefit of CubeSat architectures is the ability to rapidly iterate and implement upgrades to the constellation for better performance and resolution. Figure 49 is a 3D model of the MoonWatcher CubeSat scheduled to launch in 2019. Key technical specifications: 3U CubeSat architecture

<sup>101</sup> Section Author: Blair DeWitt, Lunar Station Corporation, CEO and Co-Founder

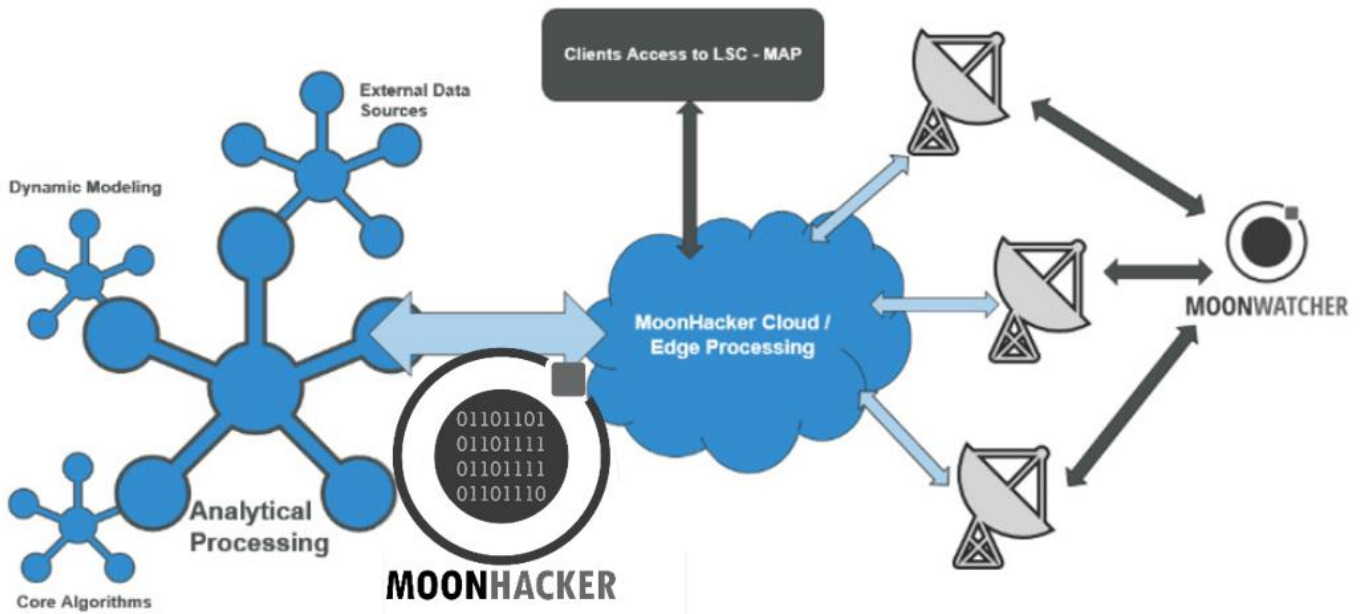
<sup>102</sup> <http://www.lunarstation.net/>

(10x10x30cm), dawn-dusk orbit, X-band communications, and estimated lunar spatial resolution: 1.15 miles. Current potential payloads: visible - 7200x7200 px, 0.55 um detector and infrared - 1- 1.7/2.4 um spectrometer. Future potential payloads: subsurface – microwave radiometer and subsurface - Ka-band radar package.



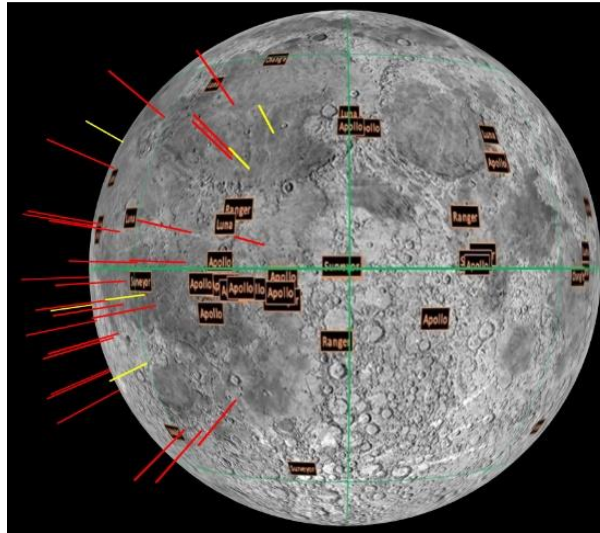
**Figure 49: LSC’s Rendering of MoonWatcher CubeSat**

The MoonWatcher constellation will continually send observations into LSC’s analytical platform called MoonHacker (Figure 50) for their machine learning algorithms to unlock new insights. This process specifically tailors the predictive analytics to meet the needs of customers and ensure the successful completion of their mission. Commercial Moon navigational services such as this one can be used for site selections, hazard avoidance pathing, or maximum lunar day power availability during operations.

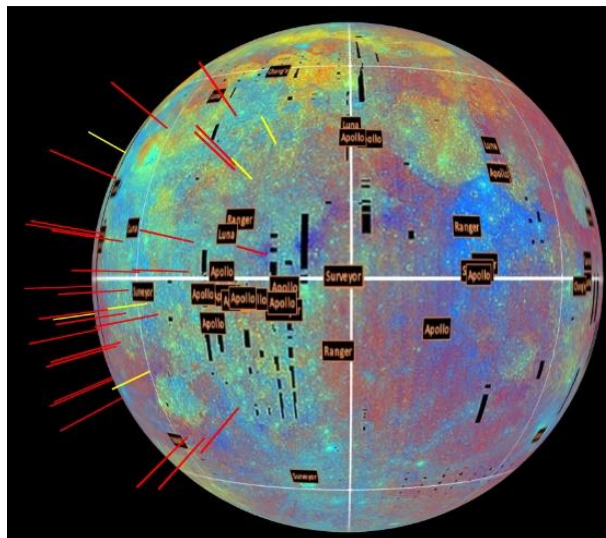


**Figure 50: Lunar Station Corporation’s MoonHacker Data Analytics**

MoonHacker will utilize innovative methodologies for customers to interact with the analytical platform. This innovative User Interface Experience (UIX) combines metadata layers overlaid on high definition 3D models of the Moon. Customers will be able to select which metadata layers are critical for their mission planning and utilize the predictive algorithms to see environmental conditions during their planned mission execution windows. The example below of LSC's MoonHacker UIX (Figure 51) shows 3D Model of the Moon with coordinates, human object locations and anticipated meteor strikes. Another example (Figure 52) shows the same information as above but now includes mineral deposits as well.



**Figure 51: LSC's MoonHacker 3D Model Showing Lunar Forecasted Meteor Storm**  
*Also shown are human objects on the lunar surface. Source of meteorite storm forecast is from the lunar weather forecasting algorithms that LSC has already developed.*



**Figure 52: LSC's MoonHacker 3D using mineral deposits metadata layer**  
*Also shown is the forecast of meteorite storms and human objects on the lunar surface.*



## **Transportation**

## Emplacement

### Delivery Capability<sup>103</sup>

Multiple companies are proposing commercial lunar landers and NASA and ESA are contemplating purchasing transportation services to the Moon. Capabilities and needs range from a few tens of kilograms to 25 MT of lunar payload delivery. Active contenders from the expired Google Lunar X Prize<sup>104</sup> and NASA's ongoing Lunar Cargo Transportation and Landing by Soft Touchdown (CATALYST) Space Act Agreement (SAA)<sup>105</sup>, with payload capabilities in parentheses, are Astrobotic<sup>106</sup> (35 – 270 kg), Masten<sup>107</sup> (100 kg), and Moon Express<sup>108</sup> (30 – 500 kg). NASA currently has the Commercial Lander for Payload Services (CLPS) Request for Proposal (RFP)<sup>109</sup> seeking landers capable of delivering >10 kg to the lunar surface. They have also published a pre-solicitation notice for a Flexible Lunar Explorer (FLEX)<sup>110</sup> lander to draw upon the capabilities of the US industrial base. ESA has also issued a Request for Information (RFI) on commercial lunar landers. Additional parties pursuing landers include iSpace<sup>111</sup> (30 kg), PTScientists<sup>112</sup> (100 kg), and SpaceIL<sup>113</sup>/Israel Space Agency (ISA).

The next generation of launch vehicles, coupled with a large commercial lander, could potentially deliver tons to the Moon from the Earth. Initially, all missions to the Moon will begin on the Earth; however, over time, emplacement missions may be staged from LEO, the NASA Gateway in NRHO or another cislunar orbit. Blue Origin<sup>114</sup> is developing a large lunar lander called Blue Moon [78]<sup>115</sup> capable of delivering 4.5 MT to the lunar surface. Cislunar Space Development Company (CSDC)<sup>116</sup> is currently proposing a reusable Moon shuttle that when starting at Earth-Moon Lagrange Point 1 (EML1) can deliver 25 MT to the lunar surface and return to EML1 on a single load of propellant. Lockheed Martin<sup>117</sup> has also proposed a large, reusable, LO2/LH2 single stage lander [79]<sup>118</sup> capable of delivering a crew of 4 and 1 MT of cargo to the lunar surface and returning the crew back to lunar orbit. During build-up of the lunar propellant infrastructure, any reusable lander must rely on propellant supplied from Earth. As the lunar propellant plant begins to ramp up production, emplacement and transportation costs will dramatically decrease as fuel is provided from the Moon. This strategy is further explored in the following section.

### Bootstrapping Deployment<sup>119</sup>

One of the large challenges of leveraging ISRU is its high cost for deployment and emplacement. The necessary infrastructure elements for ISRU include not only the processing plant itself but also its supporting systems such as power, storage, and extractors. Many existing space mission concepts consider

---

<sup>103</sup> Section Author: Dallas Bienhoff, Cislunar Space Development Company LLC, Founder

<sup>104</sup> <https://lunar.xprize.org/prizes/lunar>

<sup>105</sup> <https://www.nasa.gov/lunarcatalyst>

<sup>106</sup> <https://www.astrobotic.com/>

<sup>107</sup> <https://www.masten.aero/>

<sup>108</sup> <http://www.moonexpress.com/>

<sup>109</sup> [https://www.fbo.gov/index?s=opportunity&mode=form&id=46b23a8f2c06da6ac08e1d1d2ae97d35&tab=core&\\_cview=0](https://www.fbo.gov/index?s=opportunity&mode=form&id=46b23a8f2c06da6ac08e1d1d2ae97d35&tab=core&_cview=0)

<sup>110</sup> <https://www.fbo.gov/index?s=opportunity&mode=form&tab=core&id=06dfae16a1c27666214983da5e4d8710>

<sup>111</sup> <https://ispace-inc.com/>

<sup>112</sup> <https://ptscientists.com/>

<sup>113</sup> <http://www.spaceil.com/>

<sup>114</sup> <https://www.blueorigin.com/>

<sup>115</sup> <https://www.hq.nasa.gov/legislative/hearings/9-7-17%20ALEXANDER.pdf>

<sup>116</sup> <https://csdc.space/>

<sup>117</sup> <https://www.lockheedmartin.com/en-us/index.html>

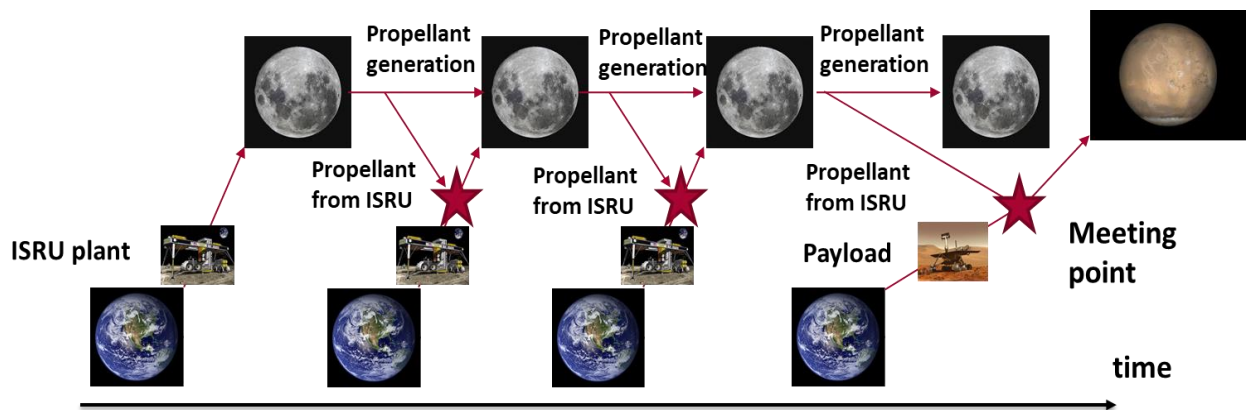
<sup>118</sup> <https://www.lockheedmartin.com/content/dam/lockheed-martin/space/documents/ahead/LM-Crewed-Lunar-Lander-from-Gateway-IAC-2018-Rev1.pdf>

<sup>119</sup> Section Author: Koki Ho, University of Illinois at Urbana-Champaign, Professor of Aerospace Engineering



a pre-deployment concept for ISRU. For example, an ISRU plant is launched and deployed to the Moon a few years beforehand, and then the propellant customer mission(s) are launched leveraging the propellant that is generated from the deployed ISRU plant. In these concepts, the deployed ISRU plant is a monolithic full-scale system whose capacity is large enough to support all the potential demands for all of the customer’s missions. However, such a single-stage deployment strategy would require a significant amount of initial investment, and thus result in a long payback period especially for a campaign with a long time horizon.

An alternative strategy is to deploy the ISRU plant in stages. In this strategy, the ISRU plant is modularized, and we deploy each module separately. Each module of ISRU plant includes both the processing plant and the supporting bus subsystems so that it can be operated independently. A bootstrapping strategy can be employed, where the later stages are deployed using the propellant generated by the earlier deployed ISRU plant stages. Thus, although the first stage of the ISRU plant is deployed using the propellant from Earth, the following stages utilize the propellant from the ISRU plant by meeting the tanker from the Moon on its way (e.g., in lunar orbit, Lagrange points, or Earth orbit). This staged deployment can not only save the total launch mass by leveraging the already-deployed ISRU plant, but also increase the flexibility of the system in response to the uncertainties in the demands of the propellant by delaying the deployment decisions. For example, in case it turns out that, the demand for propellant is not as high as expected; the deployment of ISRU can be terminated early on so that the loss is minimized. Various studies have analyzed the architecture enabled by this bootstrapping staged deployment strategy for an ISRU plant and demonstrated the effectiveness of this strategy especially when the campaign time horizon is long [80] [81] [82] [83] [84]<sup>120</sup> [85]<sup>121</sup>. Potential tradeoffs that need to be considered to enable staged deployment of ISRU include the tanker rendezvous orbit for ISRU plant deployment missions, the tradeoff for the propellant storage locations, and the level of modularization of the ISRU plant.



**Figure 53: Example of Bootstrapping ISRU Deployment Method**

**Landing Site Ejecta Mitigation<sup>122</sup>**

Because the Moon is an airless body, methods of landing on its surface are limited and for the near future will be based upon rocket thrusters. Exhaust gas from such thrusters interacts with the lunar regolith by scouring and blowing loose surface material at high velocity, and this can pose a hazard to surrounding hardware [41] [86]. The magnitude of these effects depends on the mass of the lander because that determines the scale of the thrust and therefore the density of high velocity exhaust gas interacting with the

<sup>120</sup> [Final Report](#) and [Final Presentation](#), 2016

<sup>121</sup> [Final Report](#) and [Final Presentation](#), 2017

<sup>122</sup> Section Author: Philip Metzger, University of Central Florida, Planetary Scientist

surface. Studies by NASA showed that the Apollo lunar modules blew at least a ton and possibly several tons of regolith, including dust, sand, and rocks, with each landing [87] [88]. Rocks that were 4 to 10 cm in diameter were identified in the Apollo landing videos as blowing in this gas and were photogrammetrically measured traveling 11 to 30 m/s (24 to 67 mph) as they passed through the field of view of the camera [89] [87]. These measurements were confirmed by computer modeling that predicts the same range of velocities for blowing rocks in that size range [90] [91] [87]. The blowing fine material was observed by astronauts crossing the horizon, which indicates it traveled at least that far [92]. Because those particles are too fine to resolve individually, it was not possible to measure directly their velocities in the landing videos. The computer modeling (validated by its ability to predict the rock velocities correctly) predicts that the fine particles travel at velocities that vary with particle diameter, engine thrust, lander altitude, and how far from the centerline of the rocket nozzle they began their trajectories. In general, for the Apollo lunar module landings, the computer modeling predicts that silt-size particles (smaller than 62.5  $\mu\text{m}$ ) travel 1 to 3 km/s [90] [91] [93]. The lunar escape velocity is 2.38 km/s, so these particles impact over the entire lunar globe and some escape the Moon to go into solar orbit. Therefore, complete avoidance of ejecta impacts cannot be solved with a separation distance. The modeling predicts that sand-sized particles (62.5  $\mu\text{m}$  to 2 mm) are blown 100 m/s to 1 km/s [90] [91] [93]. It should be noted that impacts from silt and sand-sized particles can happen at great distances, but the flux of these impacts decreases to an insignificant amount at some distance. Our understanding of these effects is not yet good enough to say that a certain distance will produce only acceptable damage. When the guidelines for protecting the lunar heritage sites were written, a 2 km landing distance was selected somewhat arbitrarily, with the intention of updating that guideline as we gain more experience landing on the Moon.

The damage of impacting ejecta can be severe [94] [95]. Analysis of the Surveyor 3 hardware that had been returned to Earth by the Apollo 12 mission found that the ejecta had caused at least two types of effects [96]. First, the entire surface was scoured with microscopic surface damage to the paint. Second, a countable number of holes of about 100- $\mu\text{m}$  diameter (order of magnitude) had penetrated into the paint (but not into the aluminum substrate beneath the paint). These two effects were interpreted as the effect of fine dust scouring the entire surface but were not able to penetrate, and the less numerous sand-sized particles penetrating into the paint because of their greater momentum per impact area. No impacts from gravel or rocks were observed on the hardware, which is not surprising because those size particles are less numerous so from a single nearby landing the chances of a strike occurring were low. However, if a gravel or rock strike had randomly occurred, the damage would have been significant. These effects should be less for a smaller lunar lander, because the density of the rocket exhaust gas will be less and therefore particles will experience less aerodynamic drag and will achieve much lower velocities as they fly outward into lunar vacuum. This will limit the distance they travel and lower both the flux and impact velocity at any given distance, reducing the damaging effects. The effects are also affected by the number and arrangement of engines on a lunar lander, how high they are mounted above the surface, and whether they are operated in pulsed or steady state modes. Multiple engines will cause enhanced erosion and ejection along the symmetry planes between each pair of adjacent thrusters. Mounting engines higher allows the gas to expand more before it impacts the lunar surface so the density is lower, reducing erosion rate and velocity of the ejecta. Pulsed engines will greatly enhance the erosion and ejection effects, because each time a thruster stops then restarts it causes the standoff shockwave over the lunar surface to slap the surface, splashing more particles off the surface upward into the gas flow where it is blown radially away.

To mitigate these effects there are several options. First, the landing zone can be located in a larger crater or behind a hill so the terrain naturally blocks most of the ejecta. Second, berms can be built around the landing zone. It is not clear that this method is adequate because in the lunar vacuum the dust will bounce off the larger particles on the berm's surface, scattering them into a wider range of angles so they can still rain down at high velocity on the surrounding hardware. More study is needed to quantify this. Third, a landing pad can be built by sintering, gluing, or cementing the lunar regolith into a competent surface. This method must be able to withstand the high temperature under the shockwave beneath the lunar

lander or the surface will be rapidly eroded away. Low temperature methods like the application of a polymer binder can be used around the direct landing zone to prevent lifting and blowing of material where the gas is cooler, but sintering or adequately high temperature concrete would be needed in the central region. It is not appropriate to use gravel in the immediate landing zone because tests have shown that the exhaust gas travels through the gravel, picks up fine material, and brings it back up through the gravel so that it is still blown away as ejecta. However, it may be possible to use an appropriate layering of different sized gravel in the region surrounding the immediate landing spot [97]. Fourth, curtains, fences, or localized ejecta shields can be placed around the landing zone and in front of sensitive hardware to block the ejecta from striking it [98]. The problem with curtains and fences is that if they are placed too close to the landing site then they can be blown over by the exhaust gas, but if they are placed too far from the landing site then they must be very tall and therefore very massive to block the ejecta. More study is needed to see if a practical and effective curtain or fence can be designed.

There is a concern that ejecta effects might be worse inside the Permanently Shadowed Regions (PSR). Laboratory experiments indicated that the lunar regolith might be less compacted in regions where there is no diurnal thermal cycling [99]. Further experiments showed that the amount of soil compaction scales with the amplitude of the thermal cycling [100]. Several data sets from the LRO and the LCROSS Impact have indicated that the regolith may in fact be less compacted at higher lunar latitudes poleward of about 70 degrees north and south, and especially in the PSR [101] [102] [100]. These results suggest that the soil might be very loose in the PSR. If this is correct, then there may be much greater problems with ejecta for landers going directly into the PSR. It might be necessary to land outside these craters then drive in, using wheels designed for traveling in very “fluffy” regolith. A landing pad could then be built inside the crater to permit direct fly-in and fly-out.

The construction of a landing pad can be very simple and inexpensive. If the soil is loose, it can be compacted by a lunar rover fitted with a tamping/vibrating device or a roller filled with regolith to give it mass. It can then be graded flat with a bulldozer attachment on the same rover [103]. NASA and others have developed technologies for sintering lunar regolith with microwaves or infrared heating [104] [105] [106] [107]. Such a sintering device can be fitted onto the same rover to accomplish this. The surrounding zone around the sintered surface can be scraped clean of the looser material, forming it into berms to help block any ejecta that still does occur [108], and the scraped surface can be glued down by spraying a polymer palliative using a technology whose development was funded by NASA [109]. The worst part of this scenario is that the polymer palliative must be brought from Earth (until later chemical processing of lunar ice is able to make it in situ). An alternative is to rake the soil to extract gravel and rocks that can be used on the landing pad’s apron [97], or to continue sintering the apron.

## **Lunar Surface**

### **Surface Material Transport<sup>123</sup>**

There are three key areas where lunar surface transportation becomes crucial. The first is the transportation and placement of the extraction equipment. As stated in the Thermal Mining Sizing section, a single extraction tent would have to be moved as many as 128 times to cover over 100,000 m<sup>2</sup> each year. The second key transportation area is moving the volatiles from the extraction site to the processing center. The processing plant would most likely be located in the Permanently Shadowed Regions (PSR) but could be a substantial distance from the extractor that is constantly being relocated. The third transportation focus is moving the product from the processing and storage facilities in the PSR to a landing site for distribution to customers. It may not be practical to refuel in the PSR and as mentioned in the Landing Site Ejecta Mitigation section, shuttle-landing pads may be required to be outside of the crater due to ejecta hazard. This could put them up to kilometers away and potentially even beyond the steep slopes of a crater.

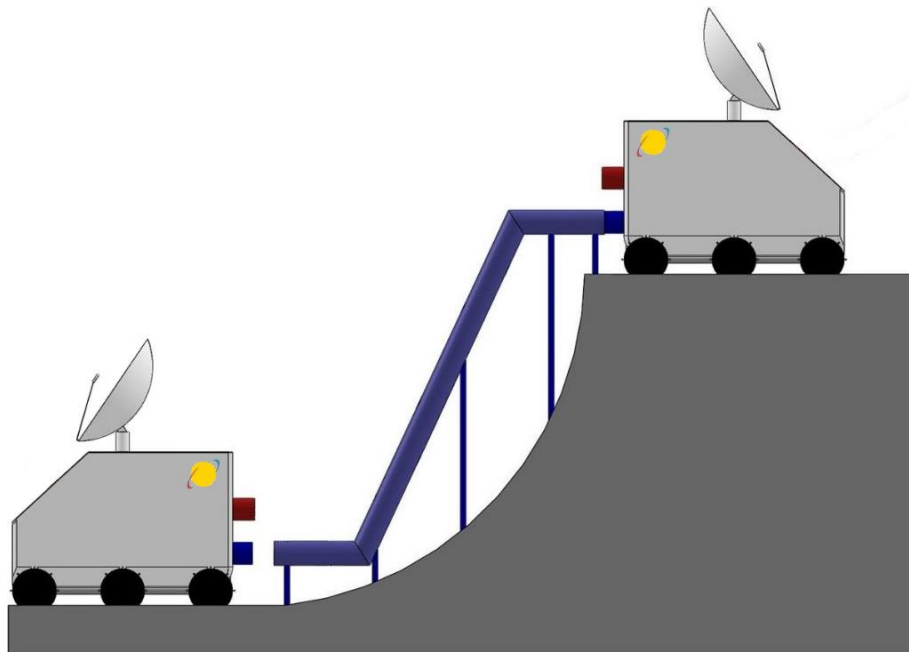
---

<sup>123</sup> Section Author: Justin Cyrus, Lunar Outpost, CEO

In order to transport the commodities over such vast and inhospitable distances, two concepts are being investigated. The first is to develop a piping system from the extraction fields to the processing plant and then from the processing plant to the customer's shuttle. Although this simple solution would meet many of the logistics need, there are a few drawbacks. The tent deployment method is mobile and therefore piping infrastructure would have to be dismantled, reassembled, and inspected each time the tent structure is moved. The extreme cold environment of the PSR may be challenging for flexible ducting and would solidify water and liquid oxygen being transported. Heaters or cryocoolers would be needed to maintain the piped product in a liquid or gaseous state depending on where in the crater the pipeline was. This causes an obvious risk if thermal management of the pipeline was interrupted and fluids froze in the line. Not to mention, the mass of material that would have to be delivered to the lunar surface. A pipeline could be required to traverse distances of many kilometers depending on the size of the crater being mined.

The second school of thought is to use autonomous robotic "tankers" to deliver materials and products to and from the processing facility. If operations are limited to within the PSR, this solution may be optimal. This, however, becomes an issue if robots are required to travel in and out of craters, which is not an easy task due to the challenging terrain of the craters and the limited mobility of current lunar robotic systems.

Lunar Outpost Inc.<sup>124</sup> is developing an approach that combines these solutions. Piping would be used to transport product and materials in and out of the crater while autonomous robotics, Lunar Outpost Tanks (LOTank)s, deliver the material and products to and from the designated piping system. In Figure 54, the LOTank in the lower left (within the crater) would be responsible for delivering the product from the extraction or processing operation to the permanent pipeline that would then in turn transport the material out of the crater to the LOTank in the upper right (at the crater rim). From here, the second LOTank transports the product to the end customer or shuttle outside of the crater.



**Figure 54: Piping System for Carrying Material Out of Crater**

*Shown with fuelers in the crater supplying the pipeline and fuelers outside the crater receiving material from the piping system*

<sup>124</sup> <http://lunaroutpost.com/>

This hybrid solution solves many issues that each concept would face on its own. It provides an efficient, scalable solution to an otherwise hindering problem. With the pipeline outside of the PSR on the crater wall, volatiles would have a tendency to warm and flow as either a gas or liquid more readily as they are pumped out of the crater. The LOTank within the crater could also be used for moving the tent structure as it would not be needed for volatile transportation during tent structure movement. This would reduce mass requirements and cost of an initial mining operation.

### **Surface Mobility<sup>125</sup>**

Autonomous vehicle mobility has been a subject of intensive work in industry and government laboratories for many years. A highlight was the DARPA Grand Challenge of 2004 and 2005, which culminated in a 131-kilometer unmanned vehicle race in the desert south of Las Vegas. Since that time, the field of self-driving cars has gained momentum and investment. Technologies being developed for navigation and hazard avoidance can also benefit lunar robotic transportation. These include both sensors, such as LIDAR, and control algorithms. An advantage presented by the lunar environment is that it is static: there are no pedestrians, and all vehicles are presumably within a common operating picture.

The Mars Science Laboratory (MSL) rover Curiosity (Figure 55) exemplifies the state of the art in extraterrestrial mobility. It uses six articulated, separately powered wheels to accommodate surface irregularities and provide redundancy. The tires are wide for minimal contact pressure and have deep treads for good grip with low slip. All of these vehicles have operated far beyond their design lives, and give confidence that the lunar surface mobility aspect can be managed.



**Figure 55: MSL Articulated Wheels and Traction Treads<sup>126</sup>**

<sup>125</sup> Section Author: Gordon Roesler, Robots in Space LLC, President

<sup>126</sup> Image credit: NASA/JPL-Caltech

Operation within the lunar polar craters presents a few unique challenges, different from either Earth or Mars:

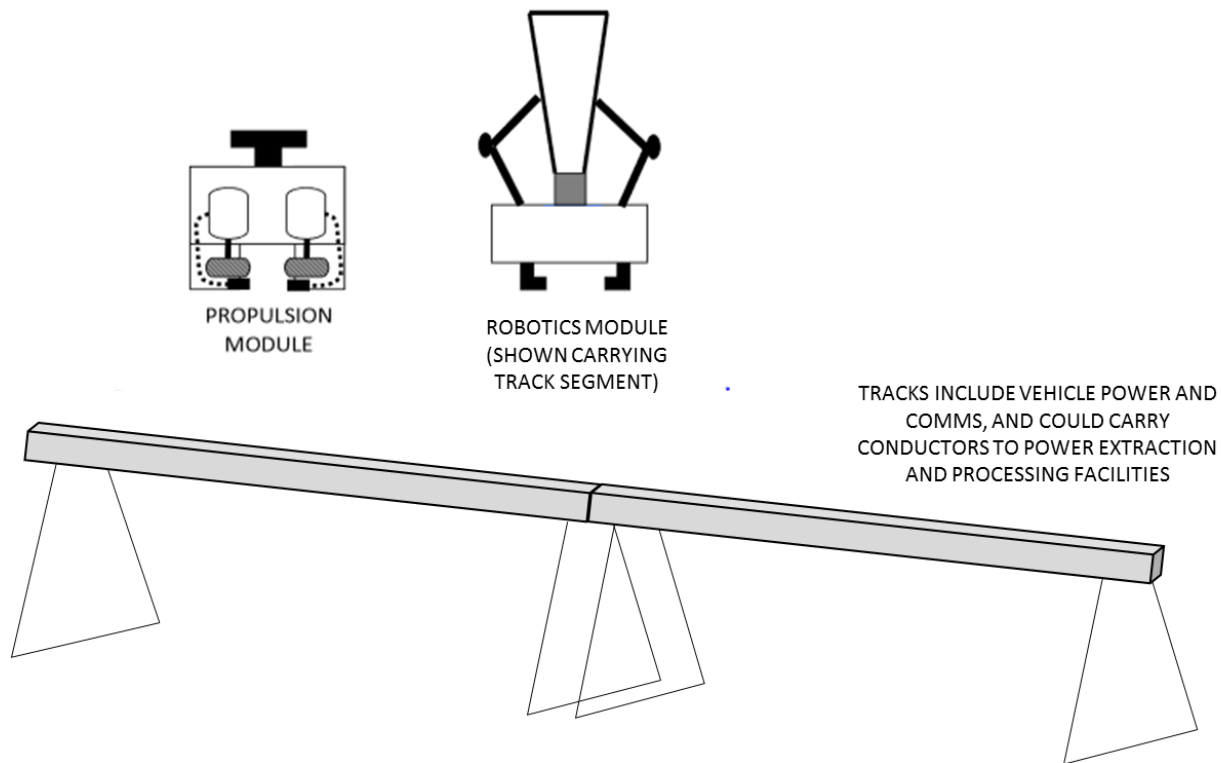
- The temperature in the bottom of these craters, which has allowed the valuable ice resource to collect there, is a challenge for vehicle design. It is far colder in these craters than on the surface of Mars. Many common parts of robotic vehicles, such as joints, bearings and motors, may not work well in such cold conditions, and new components may be required.
- Regolith, the “dirt” of the lunar surface, is abrasive and could cause open components such as joints to fail. New vehicle designs may be needed to deal with this nuisance. In addition, it can cause tires to wear out quickly, as has been seen on Curiosity (Figure 56). An alternative is to develop an elevated track system for vehicles to operate on, at least in the long-term production phase. This minimizes the stirring up of damaging regolith. It also simplifies power and navigation issues (Figure 57).



**Figure 56: Wheel Damage on MSL<sup>127</sup>**

---

<sup>127</sup> Image credit: NASA/JPL-Caltech/MSSS



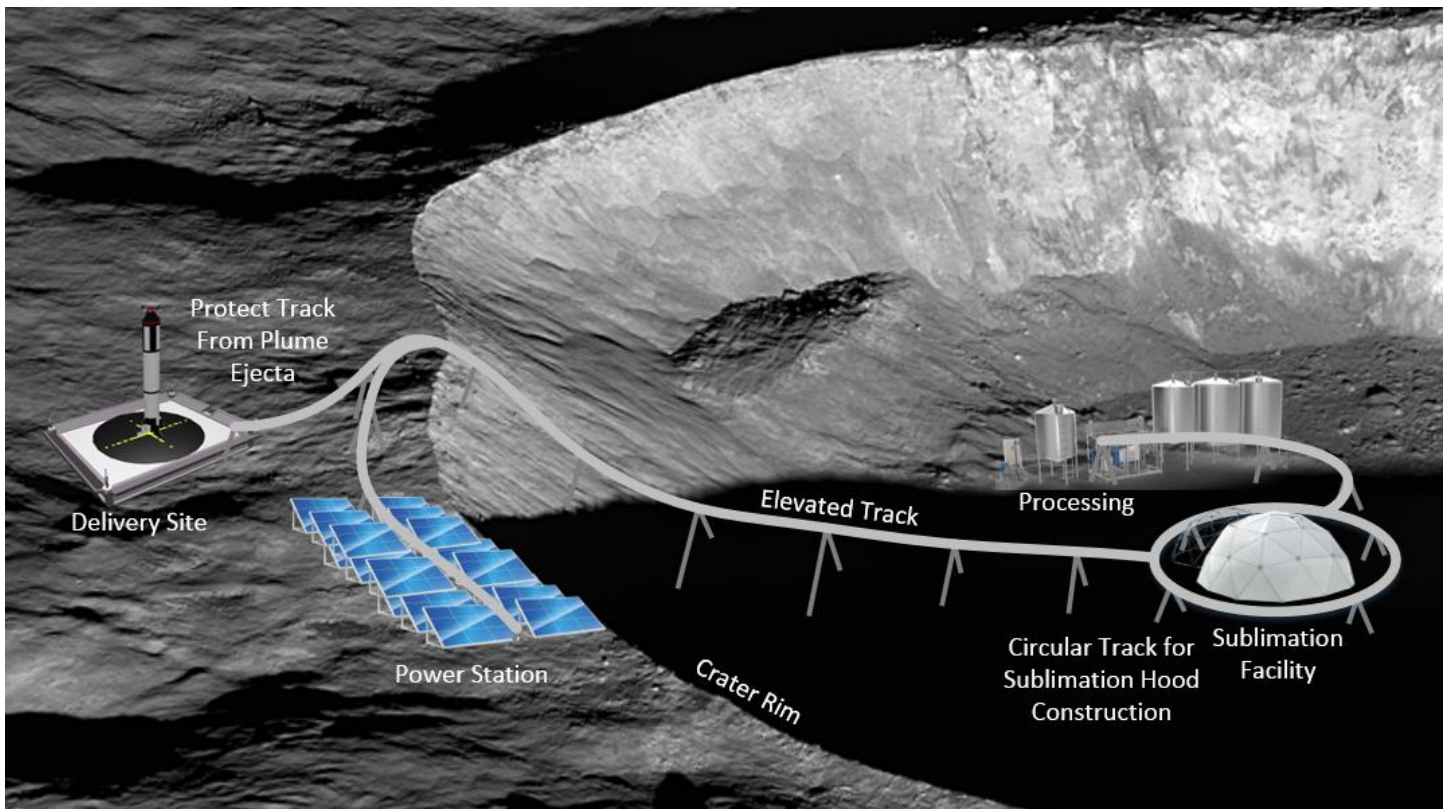
**Figure 57: Lightweight Elevated Track and Vehicle Concept for Long-Term Transportation**

- We do not presently know how firm or soft the material is in the crater bottoms. On Earth, we design vehicles differently and give them different tires depending on whether they are to operate on roads, mud, sand or snow. It is vitally important to get data on the surface firmness from prospecting missions in order that the transport vehicles can be designed properly.
- Spirit and Opportunity were powered by solar panels, and Curiosity by a radioactive thermal power source. These have worked well, but the vehicles move very slowly. Curiosity's normal speed is 30 meters per hour, which is much slower than a baby crawls (Curiosity's RTG only produces 500 watts). It is likely that efficiency will demand higher speeds in the mining system, and higher speed means more power. The power alternatives for lunar transport vehicles are:
  - Beamed power from the power stations outside the crater rim
  - Battery storage of energy, which requires the vehicles to go to a charging station periodically
  - Vehicle mounted fission reactor that require active heat rejection
  - Electrically conducting rail if the vehicles operate on tracks like a terrestrial third rail for electric locomotives
- The bottom of the craters is very dark, hindering camera-based means of navigation. LIDAR could be used for path identification and obstacle detection. For the vehicles to maintain position awareness, a local navigational grid is needed, which can be easily established with a few RF transmitters. Positioning could also be obtained using a few satellites orbiting the Moon, similar to Global Positioning System (GPS) for terrestrial navigation but probably requiring fewer satellites. If a track system is used, navigation is very simple, as only the position along the track is required, and there is no need for obstacle avoidance.

Transport functions and requirements will be specific to different phases of operations: initial post-landing tasks; site construction; steady-state operations; and servicing and repair tasks. Once these operations are fully defined, the suite of transport vehicles can be efficiently designed, with one vehicle type performing multiple functions. For example, a common transport module might have changeable robotics attached to it, so the same mobility module can assist in plant construction, ice transport, inspection and repair as described in the Universal Platform section.

Ultimately, mobility will be greatly facilitated by establishing improved transport routes. Alternatives for improved routes could include:

- Compaction or laser sintering of the regolith surface to create “roads”
- Application of a chemical binding agent (as is done terrestrially with asphalt, but much lower quantities required due to low speeds and low vehicle weights)
- Erection of elevated tracks, as described above, to minimize regolith contamination, ease requirements for navigation and obstacle avoidance, and provide power to the vehicles (Figure 58).



**Figure 58: Elevated Track Layout for Long-Term Transportation around Site**

### Lunar Surface to Orbit

#### Chemical Propulsion<sup>128</sup>

Commercial providers including CSDC are developing reusable lunar landers capable of completing cycles to the lunar surface. These Moon shuttles are able to deliver payloads to the lunar surface and return payloads back to their starting location in cislunar space (Low Lunar Orbit (LLO), NRHO, Lagrange points

<sup>128</sup> Section Author: Dallas Bienhoff, Cislunar Space Development Company LLC, Founder

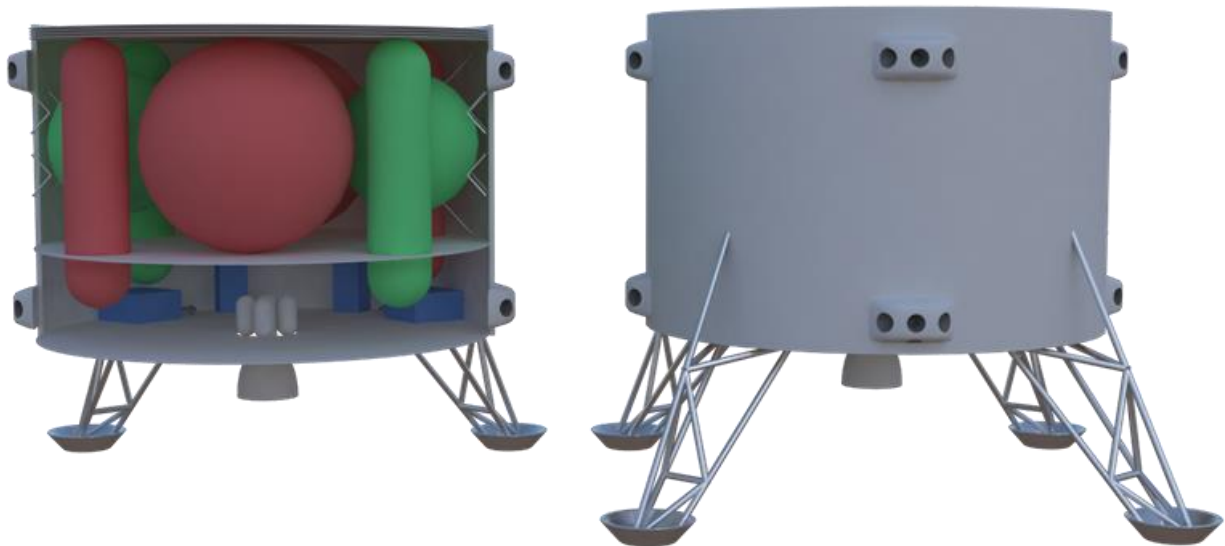


or LEO). For example, using one load of propellant, CSDC's Moon shuttle concept is sized to deliver 25 MT to the Moon from EML1 and return with no payload. If there is a need to return payload from the lunar surface back to EML1 during this cycle, the amount of cargo that can be brought to the lunar surface will be less than 25 MT. This can be calculated with the following equation:

$$m_{down} = 25 \text{ MT} - m_{up} * 1.8$$

In this equation,  $m_{down}$  is the amount of mass brought down from EML1 to the lunar surface.  $m_{up}$  is the amount of mass picked up and delivered from the lunar surface back to EML1. The equation considers the loop from EML1 to the lunar surface and back to EML1 as requiring all of the propellant in the shuttle. In addition, the 25 MT and ratio of 1.8 are specific to the CSDC shuttle and would be different for an alternate vehicle. Therefore, for this vehicle, if you wanted to return 10 MT of payload from the lunar surface to EML1 for example, you could deliver 7 MT to the lunar surface during that cycle.

Vice versa, these cycles may also begin on the lunar surface, deliver a payload to a location in cislunar space, and return with a payload back to the lunar surface. Independent of starting location, the total delta-v requirement between EML1 and the lunar surface can be assumed the same at 2.5 km/s [110]. Thus, the equation above can be adjusted to represent a starting location on the lunar surface, delivery to EML1, and return to lunar surface simply by switching  $m_{down}$  and  $m_{up}$ . If refueling with lunar derived propellant on the surface, CSDC's Moon shuttle can deliver 25 MT to EML1 and return without payload. Other commercial providers have claimed to be able to deliver up to 70 MT during similar cycles starting from the lunar surface. Moon shuttles, such as the one being developed by CSDS (Figure 59), will be the initial distributors of lunar propellant exported for use in cislunar space. These shuttles require propellant to deliver payload to orbit creating a "gear ratio" from the lunar surface to EML1 or NRHO of 2:1. This means that the lunar propellant plant must produce twice as much propellant as is needed by end users at either of those locations.



**Figure 59: Cislunar Space Development Company's Moon Shuttle**

*CSDC's reusable LO2/LH2 Moon shuttle is sized to deliver 25 MT from EML1 to the Moon's surface and return without refueling. Its maximum roundtrip capability, applicable to crew-only missions, is 11 MT.*

### **Moon to LEO Cost Savings<sup>129</sup>**

One of the major expenses associated with lunar ISRU propellant is the method used for taking the propellant, after it has been extracted and purified, and shipping it to end users in cislunar space, particularly in LEO. While initially this shipping would be performed by the same chemical rocket systems that are used to deliver the ISRU harvesting equipment to the lunar surface, the ~6.2 km/s delta-v requirement to ship materials back to LEO means that the vast majority of the lunar propellant would be consumed in the shipping process. The gear ratio of propellant mined compared to net propellant delivered to LEO is approximately 6:1 even for a high-efficiency LOX/LH2 chemical propulsion system; much more challenging than the 2:1 ratio from the lunar surface to EML1 or NRHO. This means that for every kg of propellant sold in LEO, over 6 kg have to be produced on the lunar surface, and implies that the cost of 1 kg of propellant in LEO would be 6 times higher than the cost of producing 1 kg of propellant from the lunar surface.

Fortunately, there are promising methods that can be used to reduce this “gear ratio”. This can be achieved by reducing or eliminating the propellant required to launch materials from the lunar surface to lunar orbit and by using aerobraking/aerocapture methods that can dramatically reduce the amount of propellant needed to ship materials from the Moon or Lagrange points back to LEO (explained further in the Aerobraking/Aerocapture for LEO Delivery section). Reducing this gear ratio not only lowers the ratio of the cost of 1 kg of propellant in LEO to the cost of extracting 1 kg of propellant on the Moon, but it also can dramatically reduce the amount of extraction hardware needed to support a given amount of propellant demand in cislunar space. This can dramatically reduce the up-front capital expenditure required to establish the lunar propellant mining infrastructure for a given projected demand level. It also opens up the option of delivering water or ice to a cislunar processing plant rather than having it be located on the lunar surface.

### **Propellantless Ascent<sup>130</sup>**

As mentioned earlier, for launching materials from the lunar surface to orbit, initially, the easiest solution is to use the same lander vehicles used for delivering the infrastructure during emplacement. This is especially true if the landers are designed as reusable Moon shuttles that could launch the resulting propellants back into orbit (even if better methods replace rocket launch for most bulk propellant shipping, reusable rocket-powered landers will still likely be needed for shipping goods, equipment, and personnel that are too fragile to launch with a propellantless launch method).

However, burning 30-50% of the lunar propellant just to reach a transfer station in LLO, NRHO, or one of the Lagrange points is not an efficient way of shipping bulk materials like water. Due to the lack of an appreciable atmosphere, and the shallowness of its gravity well, there are several “propellantless” launch methods that could be practical for lofting bulk payloads from the lunar surface with only a tiny bit of propellant used in the process (for orbit circularization). Two of the more promising “propellantless” launch techniques are electromagnetic launch, and rotary sling-tethers.

### **Electromagnetic Launch<sup>131</sup>**

For smaller payloads, an alternative to rocket-propelled launch to orbit is electromagnetic launch. The velocity required to reach a Lagrange point from the lunar surface is only about 2.8 kilometers per second, which is easily provided by an electromagnetic launch system [111]<sup>132</sup>. The ideal payload to launch with such a system would be liquid water, because of its higher density compared to hydrogen and oxygen

---

<sup>129</sup> Section Author: Jonathan Goff, Altius Space Machines, President and CEO

<sup>130</sup> Section Author: Jonathan Goff, Altius Space Machines, President and CEO

<sup>131</sup> Section Author: Gordon Roesler, Robots in Space LLC, President

<sup>132</sup> <https://doi.org/10.3390/machines1010050>

produced by electrolysis. Because an electromagnetic launcher is fixed on the lunar surface, it could be oriented to deliver payloads nearly continuously to a Lagrange point facility. Launching to a facility at a point with significant orbital velocity, such as NRHO, would restrict the times of operation of the launcher to those when the orbiting facility was at the appropriate coordinates to intercept the ascending payload.

### Rotary Sling-Tethers<sup>133</sup>

Another promising option was first proposed almost 30 years ago<sup>134</sup>, is a rotating lunar sling tether, as shown below in Figure 60. In this concept there is a central tower designed to rotate around its base, with two tethers unspooled from the top of the central tower. The central tower can spin the two tethers fast enough that their tip speed is faster than lunar orbital velocity, and potentially faster even than lunar escape velocity. Because this spinning takes place in vacuum, rotational energy can be added gradually over the course of hours or even days. Once the tether tips are moving at the desired tip velocity, payloads can be released simultaneously from both tips, flinging them into an orbit with a perilune at the release height, and an apolune driven by the release velocity. Once at apolune, the payload's orbit could be circularized either by small on-board thrusters, followed by rendezvous with a lunar orbital propellant facility or tanker vehicle, or by a slightly-suborbital rendezvous with a small space tug which could circularize the orbit of the payload and then deliver it to the facility or tanker. If the depot facility wants to be in a high-lunar orbit like NRHO or one of the Lagrange points, it might make sense to have a tanker/tug pair stationed in a polar LLO to capture the payloads, aggregate them, and then transfer them the rest of the way to the high-orbit facility. Also, while historically most proposed sling tethers have had a payload on one tether and a counterweight on the other, there's no particular reason both tethers couldn't launch payloads. Two sets of tugs or receiving vehicles would be needed on orbit, in planes 180 degrees out of phase with each other, but that might be an acceptable price for doubling the system's throughput and energy efficiency.

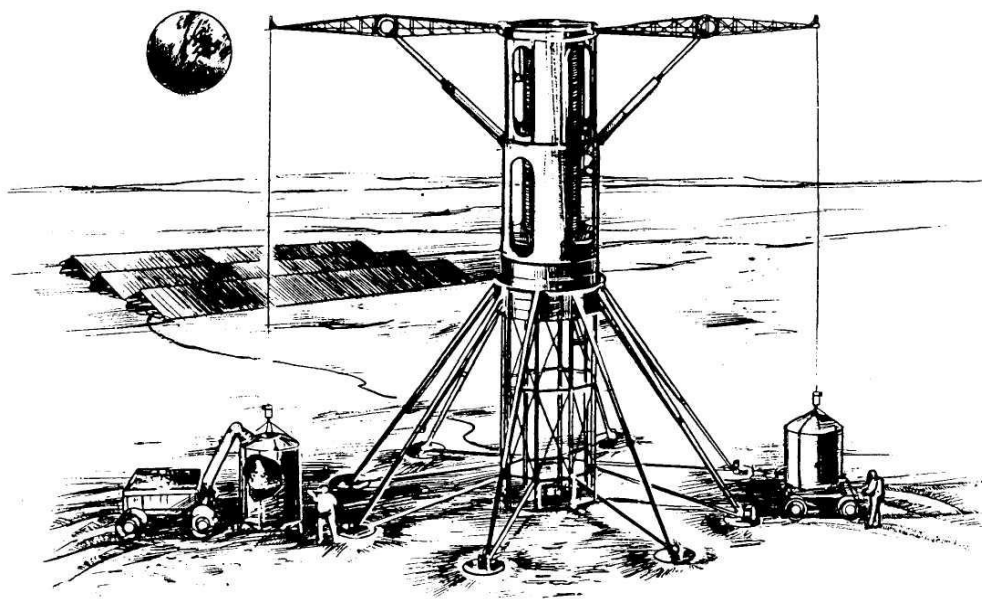


Figure 60: Sling Tether Launcher Illustration<sup>135</sup>

<sup>133</sup> Section Author: Jonathan Goff, Altius Space Machines, President and CEO

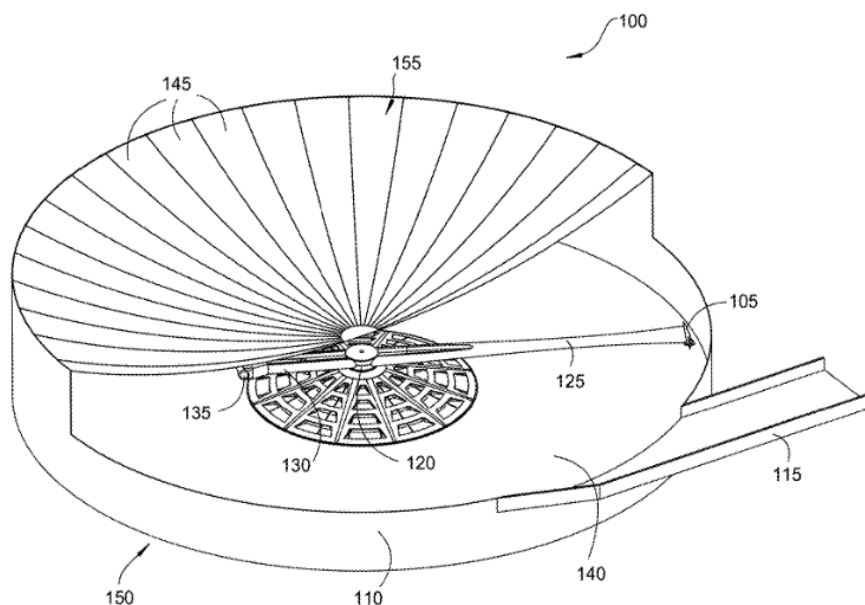
<sup>134</sup> Baker, D., and Zubrin, R. "Lunar and Mars Mission Architecture Using Tether-Launched LLOX." AIAA-90-2109. Available online at:

<https://forum.nasaspaceflight.com/index.php?action=dlattach;topic=5420.0;attach=14770;sess=0>

<sup>135</sup> Image Credit: Baker and Zubrin

To give an idea of how effective such a system could be, using Baker and Zubrin’s original numbers, a sling-tether system with Kevlar tethers and sized to sling a pair of 1 ton water payloads into a polar LLO every day could have a mass as low as 10 tons. That is small enough to fit on a single lunar lander. In addition, this system would require less than 70 kW<sub>e</sub> of electrical power. That would provide over 700 tons of propellant to lunar orbit per year with the only propellant consumed along the way being the propellant needed for orbit circularization (<3.5% of launched mass vs >35% of takeoff mass for LOX/LH2 chemical launch). Due to the small size of such a sling-tether system, it might lend itself to early emplacement, to enhance the shipping efficiency of propellant off the lunar surface as early as possible in the propellant system’s operational timeline.

Another important consideration for lunar sling-tethers is that while such ideas have been around for several decades, there is a company actively developing the required technology for terrestrial small satellite launch. This company, SpinLaunch<sup>136</sup>, has raised \$40M to build a terrestrial proof-of-concept system that is actually higher capacity, both in payload size and tip speed, than would be required for lunar applications. Because the SpinLaunch system is being used for Earth-to-orbit launch, the whole system has to be housed in a massive vacuum chamber, and significant challenges exist related to handling the transition from vacuum to atmospheric flight, including the thermal heating and aerodynamic loads generated by low-altitude hypersonic flight. None of this would have to be dealt with for lunar launch. It is unclear if SpinLaunch has interest in lunar launch applications, but if their terrestrial launch system is successful, even in demonstration operations, their system would retire almost all of the technical risks associated with implementing a lunar sling-tether system.



**Figure 61: SpinLaunch Circular Mass Accelerator Illustration<sup>137</sup>**

<sup>136</sup> <http://www.spinlaunch.com/>

<sup>137</sup> Yaney, J., “Circular Mass Accelerator System.” US Patent Application US2018/0194496 A1. Accessed online: <http://www.freepatentsonline.com/20180194496.pdf>

## In Space

### Chemical Propulsion<sup>138</sup>

ULA has been developing a revolutionary new upper-stage called the Advanced Centaur (Figure 62)<sup>139</sup>. Advanced Centaur is a unique stage, delivering unprecedented extended duration and capability in space on top of its basic upper stage functionality.

Advanced Centaur is based on Centaur V, a high performance second stage. The Centaur family has an extensive flight history, successfully delivering commercial, NASA, and national security payloads safely to space. Amazingly, more than 50 years after its initial flights it maintains the best mass fraction of any LH2/LO2 stages in the world.

The key enabling technology for the Advanced Centaur variant is the addition of long duration, low boiloff insulation, extended duration avionics, and the IVF subsystem<sup>140</sup> for tank pressurization, power, and propulsion. The long duration capability allows the stage to make burns, such as lunar orbit insertion burns, away from Earth orbit. Remarkably, high  $I_{sp}$  chemical propulsion has not been demonstrated in cislunar or interplanetary space to date despite obvious performance benefits. IVF is an internal combustion engine subsystem that burns hydrogen and oxygen to provide electric power, autogenous pressurization of LH2 and LO2 tanks without helium, and replaces storable propellant for Attitude Control System (ACS) thrusters with gaseous hydrogen and oxygen (GH2/GO2) thrusters. IVF transforms Centaur into a reusable stage by eliminating the need for all consumable commodities except for LH2/LO2, with helium and storables eliminated from the logistics stream. The marriage of long duration with IVF means that Advanced Centaur offers the ability to be a fully reusable lunar ISRU propellant transport.



**Figure 62: Advanced Centaur Upper Stage**

A completely reusable ISRU transportation architecture based on hydrogen and oxygen offers fast transfers, high  $I_{sp}$ , and the ability to operate on only ISRU commodities for maximum cost effectiveness.

---

<sup>138</sup> Section Author: Jon Barr, United Launch Alliance, Program Manager

<sup>139</sup> [https://www.ulalaunch.com/docs/default-source/evolution/vulcan-aces-and-beyond-providing-launch-services-for-tomorrows-spacecraft-\(american-astronomical-society-2016\).pdf?sfvrsn=5662c8c\\_2](https://www.ulalaunch.com/docs/default-source/evolution/vulcan-aces-and-beyond-providing-launch-services-for-tomorrows-spacecraft-(american-astronomical-society-2016).pdf?sfvrsn=5662c8c_2)

<sup>140</sup> [https://www.ulalaunch.com/docs/default-source/extended-duration/enabling-long-duration-spaceflight-via-an-integrated-vehicle-fluid-system-\(aiaa-space-2016\).pdf](https://www.ulalaunch.com/docs/default-source/extended-duration/enabling-long-duration-spaceflight-via-an-integrated-vehicle-fluid-system-(aiaa-space-2016).pdf)



**Figure 63: Advanced Centaur in Flight**

Other chemical propellant alternatives exist such as methane/LOX that could still take advantage of ISRU LOX, though not with the full utilization of hydrogen and oxygen. Other LH2/LO2 stage options to Advanced Centaur exist as well, though none appears to be designed around in-space reusability to the degree of Advanced Centaur.

#### **Nuclear Thermal Propulsion<sup>141</sup>**

Nuclear Thermal Propulsion (NTP) is an obvious option for a Mars Transfer Vehicle that is receiving renewed interest within NASA. NASA awarded an \$18.8 million contract to BWXT Nuclear Energy in August 2017 to design a nuclear reactor<sup>142</sup> for NTP. NTP represents an obvious potential customer for ISRU hydrogen. Despite comparable thrust-to-weight of chemical propulsion options, it is less obvious as a propulsion system for a cislunar transfer vehicle simply because operating it in LEO raises questions of nuclear safety, with the concern that a failure of the stage or engine, the reactor could reenter while still radioactively hot. Similarly, a hot reactor in a lunar lander, particularly one that might be in proximity to people (e.g. as a lander for a lunar village) creates more concerns. For this study, we have looked at NTP as a customer for the ISRU, assembled and tanked in a safe cislunar orbit, but we have not assumed that the NTP is the ferry for propellant from the lunar surface to cislunar depot or from a cislunar depot to LEO.

#### **Nuclear Electric Propulsion<sup>143</sup>**

Nuclear fission power brings remarkable benefits to scalable, sustainable space transportation architectures, enabling repeatable operations that can cost-effectively move high-mass payloads through cislunar space and beyond. Modern space nuclear power systems under development through NASA and industry programs offer many advantages including: relatively low masses and form-factors enabling easy spacecraft integration; extended operational durations; the ability to operate in traditionally hostile environments and in regions fully shadowed or distant from the Sun; and high operational reliability and safety. The Nuclear Fission section outlines non-propulsion applications of a fission reactor in generating power for processing propellant on the lunar surface.

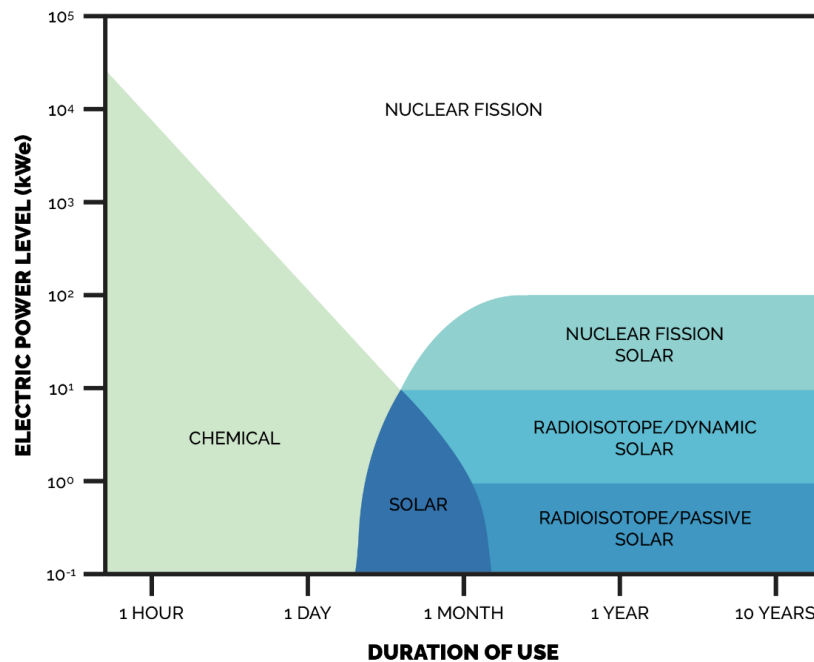
---

<sup>141</sup> Section Author: Jonathan Barr, United Launch Alliance, Project Manager

<sup>142</sup> <https://www.nasa.gov/centers/marshall/news/news/releases/2017/nasa-contracts-with-bwxt-nuclear-energy-to-advance-nuclear-thermal-propulsion-technology.html>

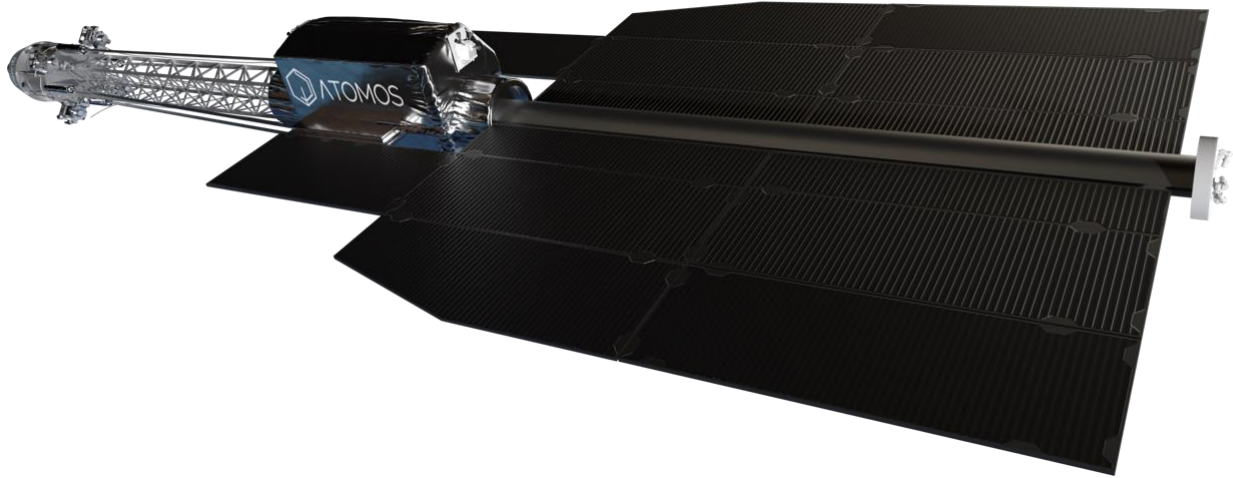
<sup>143</sup> Section Author: Brandon Seifert, Atomos Nuclear and Space, Chief Marketing and Strategy Officer

Atomos Nuclear and Space is developing a spacecraft leveraging Nuclear Electric Propulsion (NEP) technologies optimized for in-space transportation of high-mass payloads. Historically NEP would utilize non-ISRU Xenon as its propellant, which would make NEP a competitor to ISRU based propulsion, the focus of this paper. However, NEP has options to utilize LH2 propellant, which could instead make it a customer and critical transportation element of the lunar propellant architecture. Working with US nuclear companies and government agencies including NASA, Atomos is creating a space-rated small modular fission power system that utilizes commercially available, non-weaponizable nuclear fuels. This fission power system can be coupled with advanced electric propulsion systems (such as Ad Astra’s Variable Specific Impulse Magnetoplasma Rocket (VASIMR) engine, or the SX3 engine under development at the University of Stuttgart) and integrated into NEP spacecraft. Comprising a high specific impulse electric propulsion system powered by a high-power nuclear fission source capable of producing between 200 kW<sub>e</sub> and 1 MW<sub>e</sub>, Atomos NEP spacecraft are designed to efficiently perform high mass (tens to low-hundreds of metric tons) in-space transfers.



**Figure 64: Power Technology Regimes for Optimal Specific Power**

As the power requirements for new propulsion technologies and transportation architectures approach the hundreds of kilowatts to megawatts, nuclear-based sources of electricity quickly become the optimal power solution (Figure 64) [112]. Traditional chemical propulsion systems provide high thrust and can complete rapid transfers between the Earth and Moon within days, but spacecraft leveraging such systems suffer low propellant mass efficiency, requiring frequent refueling or only allowing transfers of smaller payloads. If refueling were not available, chemical propulsion would require an infeasible number of launches from Earth to support a useful cislunar transportation network. Contrasting existing chemical propulsion systems, Solar Electric Propulsion (SEP) can provide much higher propellant mass efficiency, but at very low thrust levels; the improved propellant efficiency comes with prohibitively longer transfer durations. Because they are currently energy starved, modern electric propulsion technologies are unrealistic to support industrial activities in space due to the extended transfer time and low thrust. These restrictions motivate the aforementioned ULA Advanced Centaur architecture and drive Atomos’ heavy-duty transportation logistics model based on nuclear electric spacecraft (Figure 65).



**Figure 65: The Atomos Nuclear Electric Propulsion Spacecraft**

Atomos also envisions using NEP to ferry propellant from lunar orbit to LEO and then return to lunar orbit. Though this raises the same safety question related to LEO operation as with NTP (Nuclear Thermal Propulsion section), there is a historic precedent for reactor operations in LEO with the Soviet Radar Ocean Reconnaissance Satellite (RORSAT)<sup>144</sup> and the US Space Nuclear Auxiliary Power (SNAP)-1<sup>145</sup> reactor in the mid-1960s. With the low specific mass and high specific impulse of a NEP system, the required propellant mass fraction for this NRHO-LEO transfer can be much lower than competing systems. The compromise is transfer duration, with electric propulsion low-thrust transfers taking much longer than high-thrust chemical transfers do. However, given that only three supply missions of 70 MT propellant per year are required to the LEO customer, durations up to 156 days (round trip) are permissible. Optimized for this payload and duration, a NEP system can consume as little as 13 MT propellant per trip, assuming lunar-mined LH2 as the propellant. A performance comparison for this mission is shown in Table 10, below.

**Table 10: In-Space Transportation Comparison for Lunar Orbit to LEO**

*(70 MT payload from NRHO-LEO and return empty to NRHO)*

*Note: Aerobraking in Earth's atmosphere may reduce propellant consumption but could be restricted for nuclear materials due to environmental and health risks.*

	Chemical (Advanced Centaur)	Solar Electric	Nuclear Electric
<b>Power Level</b>	NA	(100kWe)	(1MWe)
<b>Requisite Propellant Mass</b>	140MT split between two deliveries	11MT	13MT
<b>Transfer Duration</b>	6 days for each delivery (3 inbound, 3 outbound)	1283 days (1248 days inbound, 35 days outbound)	156 days (141 days inbound, 17 days outbound)

<sup>144</sup> <https://fas.org/nuke/space/sovspace.pdf>

<sup>145</sup> <https://www.osti.gov/includes/opennet/includes/Understanding%20the%20Atom/SNAP%20Nuclear%20Space%20Reactors.pdf>



The vision of a self-sustaining cislunar economy fueled by lunar propellant will require significant advancements in space logistics technologies and operations. Fission power is game changing, expanding power budgets by orders of magnitude in unobtrusive, compact form factors as compared to competitive energy technologies. The high power densities and long service lives offered by nuclear power technologies revolutionize space operations by increasing the available electric power for any space or surface operation and reducing the spacecraft thrust-to-mass ratio for electric propulsion vehicles.

#### **Aerobraking/Aerocapture for LEO Delivery<sup>146</sup>**

Of the delta-v required to deliver payload from the lunar surface to LEO, almost half of it (~3 km/s) is required to slow down and circularize into LEO from lunar orbital velocities. With a LOX/LH<sub>2</sub> system, this requires approximately half of the mass of the vehicle to be expended, if done purely propulsively. However, because the Earth has an atmosphere, one option would be to use atmospheric drag to shed some or almost all of the excess velocity, instead of rocket propulsion. This process is called aerocapture when the approach trajectory is a hyperbolic one and the spacecraft is decelerated enough to be captured in an elliptical or circular orbit. It is referred to as aerobraking when the vehicle starts in an elliptical orbit and uses atmospheric drag in one or more passes to enter a lower, less eccentric orbit. Many previous NASA and commercial lunar architecture studies have recommended the idea of using aerocapture to enable reusable in-space transfer vehicles, such as shown below in Figure 66. Over the years, a wide variety of solid<sup>147</sup> and inflatable decelerator concepts have been proposed for reusable lunar transportation architectures. While most of them typically require 5-20% of the returned mass in added dry mass, they are still significantly more economical than purely propulsive braking into LEO. It would most likely be possible to add a solid or inflatable aerobrake shield to an Advanced Centaur upper stage to enable more efficient deliveries from near-lunar space to LEO.

---

<sup>146</sup> Section Author: Jonathan Goff, Altius Space Machines, President and CEO

<sup>147</sup> Scott, C. et al “Design Study of an Integrated Aerobraking Orbital Transfer Vehicle.” NASA TM 58264, March 1985. Accessed online: <https://ntrs.nasa.gov/archive/nasa/casi.ntrs.nasa.gov/19850012952.pdf>



**Figure 66: Reusable Lunar Orbital Transfer Vehicle Concept Using Aerocapture<sup>148</sup>**

One other promising, but low-TRL aerobraking/aerocapture technology is Magnetoshell Aerocapture (MAC) technology<sup>149</sup>. Magnetoshell Aerocapture uses an electromagnet to trap a volume of low-density magnetized plasma around a spacecraft, which, when it passes through the atmosphere, ionizes atmospheric neutral gas particles via a charge-exchange collision, enabling the spacecraft to transfer momentum into those now-ionized particles via the electromagnet's field. Depending on the electromagnet size and power available, it is theoretically possible to create plasma volumes that act like inflatable decelerators that are tens of meters in diameter, using negligible amount of propellants to inflate the plasma bubble. Another potentially useful benefit of MAC technology is that the effective cross-sectional area of the plasma brake can be altered rapidly by varying the current flowing through the electromagnet, allowing the system to compensate for atmospheric density variations in real-time.

---

<sup>148</sup> Image Credit: Skycorp

<sup>149</sup> Kirtley, D. "A Plasma Aerocapture and Entry System for Manned Missions and Planetary Deep Space Orbiters." NIAC Phase I Final Report, 2012. Accessed online: [https://www.nasa.gov/sites/default/files/files/Kirtley\\_2012\\_PhI\\_PlasmaAerocapture.pdf](https://www.nasa.gov/sites/default/files/files/Kirtley_2012_PhI_PlasmaAerocapture.pdf)



**Figure 67: Vacuum Chamber Test of a 6U Cubesat-Scale MAC Demo System<sup>150</sup>**

In their NASA Innovative Advanced Concepts (NIAC) Phase I study, MSNW investigated aerocapture for a crewed Mars mission of similar mass to a full Advanced Centaur tanker. It was estimated that such a system could be developed with a system mass of less than 1 ton, most of which would be battery mass that would not be necessary when integrated into stage like Advanced Centaur that has significant short-duration power generation capacity. If the technology can be implemented successfully, it could enable an aerobraking kit that masses less than 1% of the returned mass of an Advanced Centaur tanker. However, it should be cautioned that while this technology is very promising, it is still in early lab testing, under a NIAC Phase II effort, and is not yet flight-ready unlike traditional rigid or inflatable aerobraking systems. Thus, it might be most prudent initially to start with more traditional aerobraking options while MAC testing proceeds in parallel.

---

<sup>150</sup> Image Credit: MSNW and Altius



## **Business Case**

## **Willingness to Pay<sup>151</sup>**

Economists view price as the intersection of a buyer's 'willingness to pay' and a seller's 'willingness to accept' payment. A negotiation process results in an agreement to participate in an economic transaction. If price is too high, customers walk away. If it is too low, investors will not finance the deal. For the transaction to take place, both parties must walk away with a sense of earned value. Willingness to pay a high price for propellant in space is a direct consequence of the tyranny of the rocket equation. Currently there is an exponential price increase as a function of distance from Earth. Note that this is the core rationale for the lunar resource business case, underscoring the economic argument to use local resources for propellant supply and reuse capital assets by refueling them rather than discarding them after a single use.

The backstop for in-space commodity prices will be set by terrestrial competition. As launch costs drop, the value of propellant at the lunar surface will fall. Commercial lunar miners will not be able to sell their early products for more than it would cost to supply the same material from Earth. If they do, a terrestrial competitor will attempt to meet the short-term demand spike. High demand and prices will also stimulate the emergence of competition from other operators (e.g. asteroid miners trying to beat the prices of lunar miners at EML1). In the long-term, the results of in-space competition would benefit the end customer by steadily reducing commodity price. For this study, it is assumed that lunar derived propellant would be sold at a 25% discount as compared to price of delivering that same propellant from the surface of the Earth.

Prices for lunar propellants will likely start relatively high. This is most likely in support of activities on or near the Moon where delivering terrestrial propellant would be very expensive. The first backstop will be the price that will trigger terrestrial competition, thus allowing early mine operators to capture a premium in value and assuring a high rate of return for early private investors. This of course assumes that the benefit of capital asset recycling (e.g. the reuse of a space asset for more than one mission) will offset the cost of refueling. Terrestrial mining experience demonstrates that as competitive supply expands, long-term prices will move steadily downward toward unit mining costs - a function of capital cost, operating cost, maintenance and deployment as well as systems productivity.

## **Customers<sup>152</sup>**

As NASA's return to the Moon and ESA's Lunar Village gets underway, the demand for propellant at or near the Moon will establish the early customer base of lunar derived propellant. With the establishment of human presence in lunar orbit (e.g. the Gateway in NRHO) or on the lunar surface, additional markets can emerge for oxygen (breathing air, oxidizer) and water (drinking, washing, radiation shielding); all of which could be produced by the commercial lunar propellant plant. Next, the use of lunar based propellant and commodities will provide a stepping-stone for interplanetary exploration. As NASA and international partners embark on the journey to Mars, fueling and stocking vehicles at EML1 (or other cislunar assembly point) will be paramount in creating a feasible and sustainable exploration program [113]. Once lunar propellant production is well established and can be delivered to LEO, the commercial launch industry (ULA, SpaceX, Blue Origin, etc.), and government space agency transportation systems (NASA, ESA, etc.) can become the dominant market for lunar derived propellant. This market exists today for LEO to GEO transportation and for Beyond Earth Orbit (BEO) science and exploration missions. All of these markets will continue to expand as the cost of in-space transportation decreases and additional commercial activities become established in cislunar space, the Moon and beyond.

---

<sup>151</sup> Section Author: Brad Blair, New Space Analytics, Managing Partner

<sup>152</sup> Section Author: George Sowers, Colorado School of Mines, Professor of Space Resources

## Demand<sup>153</sup>

Reducing the cost of propellant in space has a dramatic impact on the cost of cislunar and beyond transportation. While many people are focused on reducing the cost of launch to LEO, an important and worthy endeavor, the cost of moving through cislunar space has an even more dramatic impact on humanity's ability to benefit from the vast resources space has to offer. As Russia, China and other countries improve their use of space, America's national security will depend on the ability to maneuver throughout cislunar space anywhere, anytime. Both economic and national security needs all rely heavily on affordable, reliable propellant.

The current cost of propellant in any given location is driven by the cost of transporting the propellant to that location. While on Earth, LO<sub>2</sub>/LH<sub>2</sub> propellant cost \$1/kg, transporting it to LEO costs around \$4,000/kg<sup>154</sup>. With very efficient LO<sub>2</sub>/LH<sub>2</sub> transportation, much of the LEO launched propellant is consumed delivering that propellant beyond LEO, dramatically increasing the cost as one moves further into space (see Table 11).

Alternatively, propellant produced on the Moon will be cheapest on the Moon. Transporting the lunar derived propellant from the Moon down into Earth's gravity well quickly increases the cost of the lunar propellant because we will burn propellant to move propellant. Table 11 provides an example of the cost of lunar derived propellant at different locations, assuming \$500/kg on the lunar surface.

**Table 11: Cost of propellant from Earth or the Moon**

	<b>From Earth</b>	<b>From Moon</b>
Earth Surface	\$ 1/kg	-
LEO	\$ 4,000/kg	\$3,000/kg
GTO	\$ 8,000/kg	\$1,500/kg
GEO	\$16,000/kg	\$1,500/kg
EML1	\$12,000/kg	\$1,000/kg
Lunar Surface	\$36,000/kg	\$500/kg

Crewed lunar missions will benefit greatly by being able to refuel on the lunar surface for lander reuse, rather than delivering entirely new systems from Earth for each landing. One potential crewed architecture includes NASA transporting crew in a crew module from the Gateway directly to the lunar surface. Each lander mission will require between 14 and 50 MT of propellant on the lunar surface<sup>155</sup>. Assuming each year that there are two crewed missions requiring 25 MT each and one large cargo (such as a lunar surface habitat module) mission requiring 50 MT, the total demand for propellant is 100 MT/year on the lunar surface. Such an architecture, with fully reusable surface to orbit transportation, can make crewed lunar surface access affordable as well as enable the creation of a permanent outpost on the lunar surface. Using a propellant mixture ratio of 5.35 to 1, rather than the 8 to 1 mixture ratio of water, requires that 150 MT/year of lunar water be processed to meet the propellant demand.

---

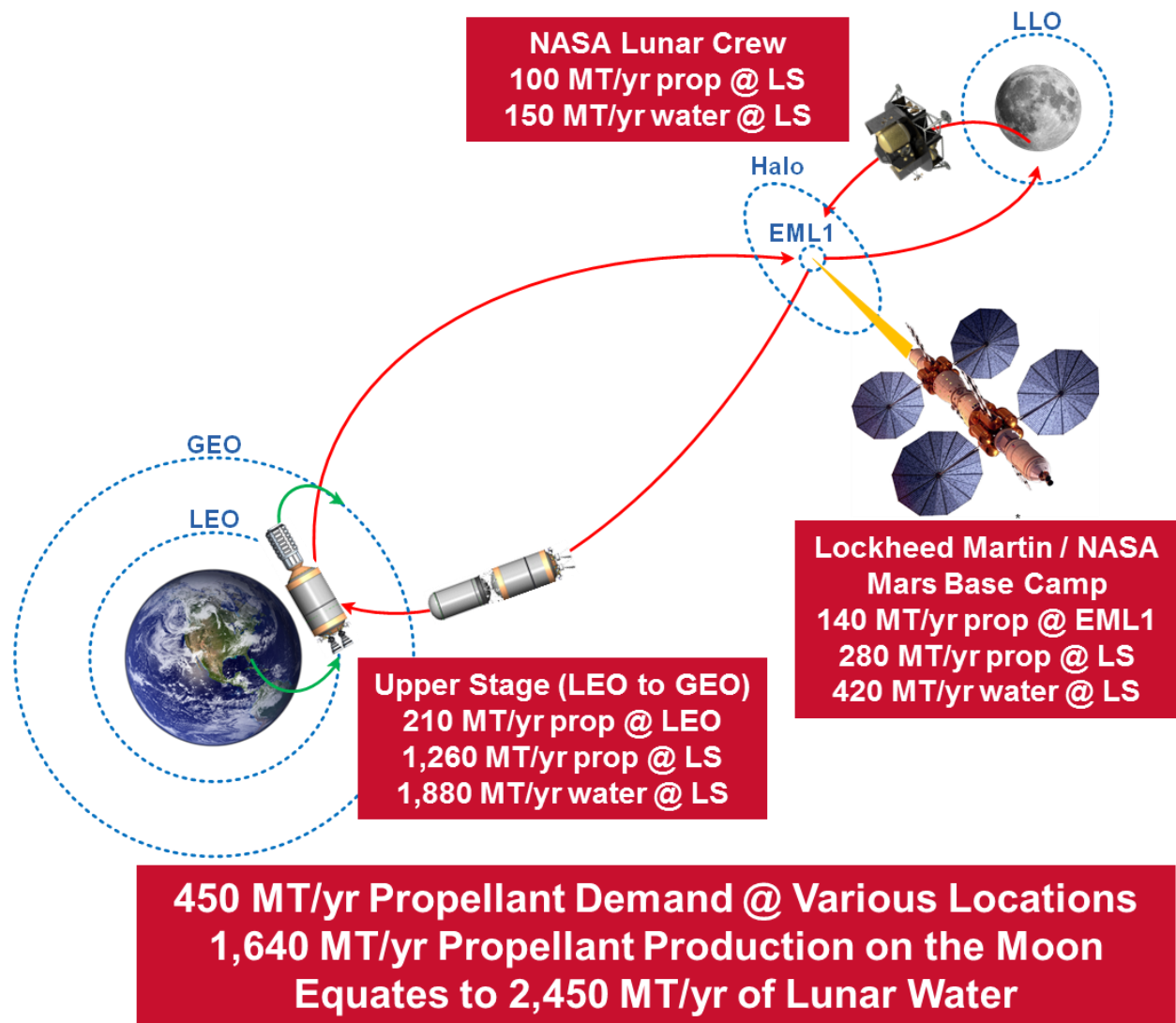
<sup>153</sup> Section Author: Bernard Kutter, United Launch Alliance, Chief Scientist

<sup>154</sup> Competition within the launch industry is likely to continue to affect this price. As the cost of delivering mass to LEO fluctuates, it will directly affect the cost of propellant on the lunar surface for the LEO customers. A time dependent economic analysis of launch cost to LEO would be required for the highest fidelity model. The estimate used in this study is based current prices and neglects the prospective claims of capabilities that have not yet been verified.

<sup>155</sup> <https://www.fbo.gov/utills/view?id=c520facdb1ffa46f8e5981eb14b33bd1>

Lockheed Martin’s Mars Base Camp concept intends to use EML1 as a staging location for Mars departures. Every 2 years each mission will require 280 MT [114] of propellant in EML1. This translates to a yearly demand of 280 MT of propellant on the lunar surface, or 420 MT/year of lunar extracted water.

By refueling an upper stage vehicle in LEO, the vehicle becomes capable of super heavy lift to GEO (potentially >35 MT) and beyond. This improves the lift capability of a single launch vehicle by greater than 2.7 times. It has been assessed that there could be demand for three of these super heavy missions per year. This generates a demand for as much as 210 MT of propellant in LEO per year. Accounting for transporting this propellant from the Moon to LEO, the demand grows to 1,260 MT/year of propellant on the lunar surface. This results in a demand for 1,880 MT/year of extracted water. Figure 68 summarizes the early need for lunar derived propellant.



**Figure 68: Initial Lunar Propellant Customers**

Once these early customers are established, EML1, energetically comparable to NRHO, will become an ideal location for industrial production. There, lunar or asteroidal material can be processed into goods for use throughout cislunar space eventually enabling construction of large satellites that provide services

(power, station keeping, etc.) for mission unique payloads. Even further out, production of solar power satellites and space colonies likely will be done at EML1. Transport of raw materials to EML1 for construction and then delivery of finished products to Geosynchronous Orbit (GSO), LEO or other destinations promises to be a market that eventually dwarfs the near term demand mentioned. All of these possibilities are unlocked by the establishment of commercial lunar propellant production.

## **Propellant Pricing**

### **Lunar Surface and EML1 Customers<sup>156</sup>**

The initial lunar surface customer will likely be a reusable crew or cargo shuttle designed to cycle to the lunar surface from an NRHO facility. From a delta-v perspective, NRHO and EML1 are close enough to assume that the \$10,000/kg delivery cost from Earth to EML1 would be the same as delivery from Earth to NRHO. In order for propellant customers to utilize non-terrestrial propellant, it has been assumed that they would seek a 25% cost savings to offset operational risk. With that 25% savings provided by the lunar propellant mine, the NRHO gateway would purchase lunar derived propellant for \$7,500/kg. Because the reusable lunar lander cyclers is agnostic to refueling in NRHO or the lunar surface, this would translate the same lunar propellant price from NRHO down to the lunar surface. Therefore, it would be economically viable for the NRHO customer to value lunar propellant at \$7,500/kg at the lunar surface or at NRHO. With current estimates up to 100 MT of propellant per year for a lunar cyclers, using lunar propellant would result in a cost of \$750M per year as opposed to the \$1B per year required to use terrestrial propellant.

Consider the EML1 customer. As stated before, it currently costs approximately \$10,000/kg to deliver material from Earth to EML1. If EML1 is used as a staging area for a Mars mission, a customer such as NASA using Lockheed Martin's Mars Base Camp may emerge there with a demand of 140 MT/year of propellant. This could be transported from Earth for a total of \$1.4B per year. On the contrary, if that propellant demand were met in EML1 by propellant delivered from the Moon, the customer would see a savings. Assuming the 25% mark down for lunar propellant, the terrestrial price of \$10,000/kg at EML1 becomes \$7,500/kg resulting in a total annual cost of \$1.05B. Subtracting out the transport price of the propellant from the lunar surface to EML1 suggests the price of propellant production for the EML1 is \$3,750/kg on the lunar surface.

### **LEO Customers<sup>157</sup>**

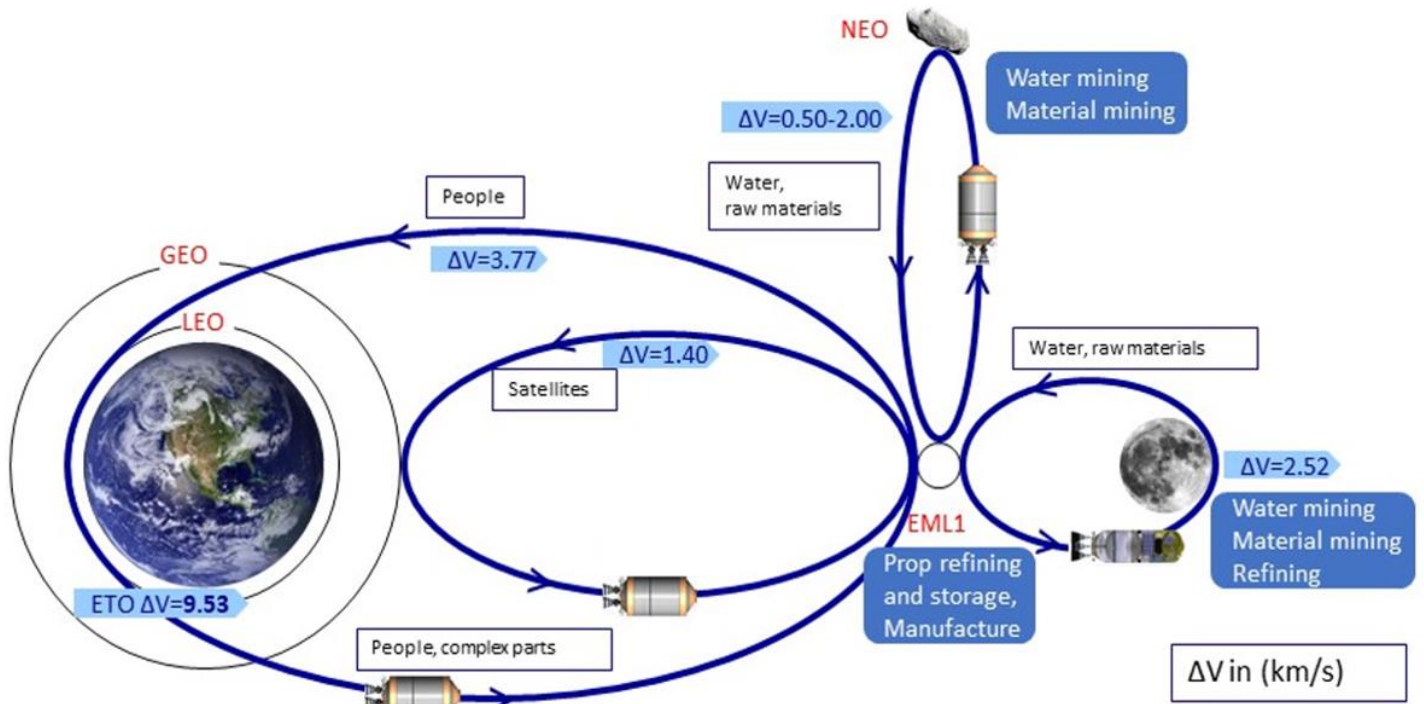
To support the Moon and EML1 customers described above, a cislunar transportation architecture would be established. One can envision a series of trade routes within cislunar space; moving people and goods from place to place and forming the backbone of a thriving cislunar economy (see Figure 69). To further fuel this economy by decreasing in-space transportation costs further, a business case can be made to provide lunar-sourced propellant in LEO for refuelable upper stages so long as that fuel is less expensive than Earth sourced propellant. A fully fueled upper stage in LEO can be used to transport super-heavy payloads from LEO to GEO and beyond. If the cost of propellant obtained from the Moon in LEO is less than the cost to ship propellant to LEO from Earth, the business case can be closed. Based on these considerations, a price point for propellant in LEO can be established.

---

<sup>156</sup> Section Author: David Kornuta, United Launch Alliance, CisLunar Project Lead

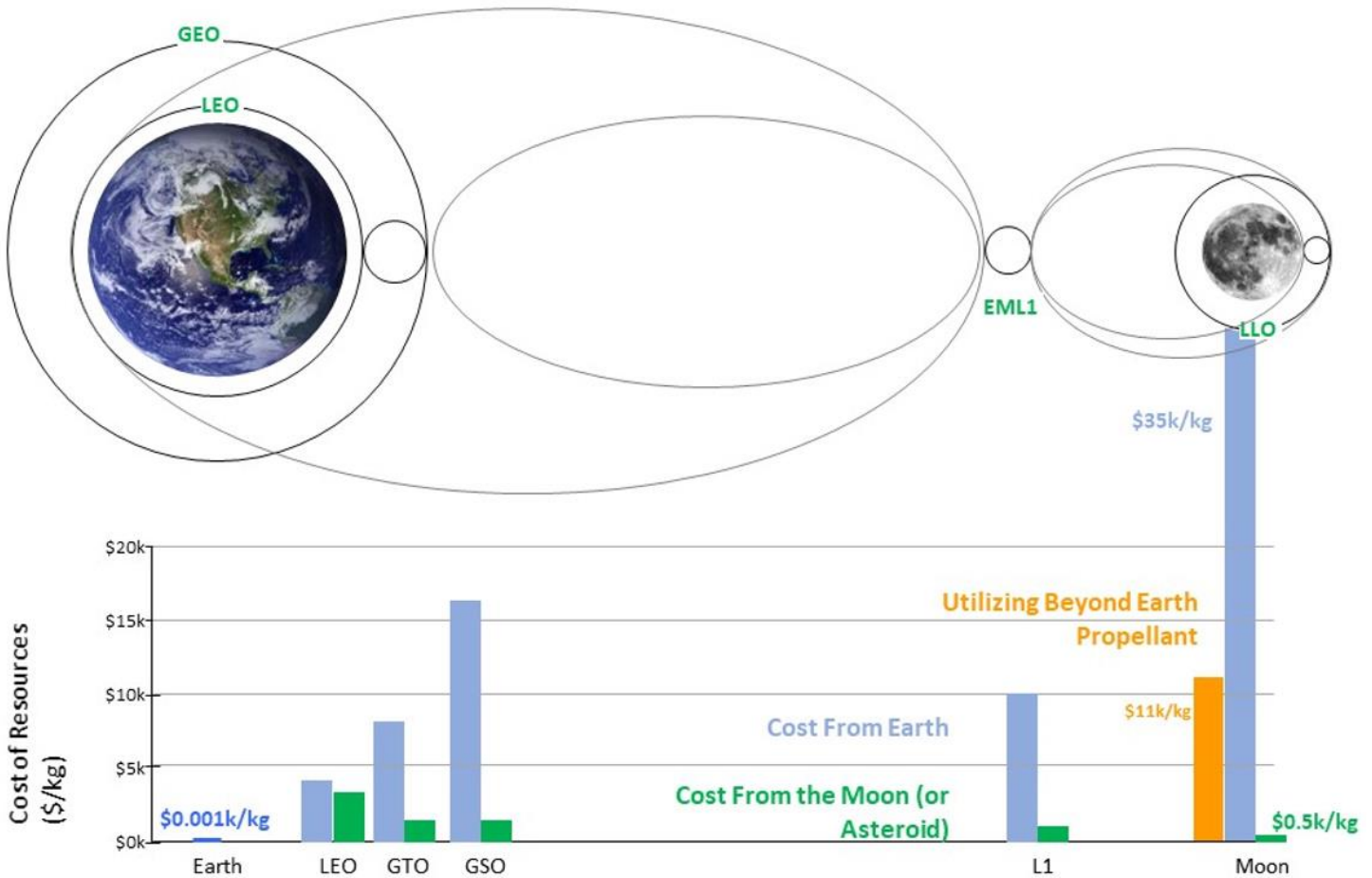
<sup>157</sup> Section Author: George Sowers, Colorado School of Mines, Professor of Space Resources





**Figure 69: Trade Routes and Economic Activities in Cislunar Space**

It currently costs approximately \$4,000/kg (see Demand) to deliver propellant from Earth to LEO. Considering a 25% discount on lunar propellant, this translates into a value of \$3,000/kg for lunar propellant in LEO. A price of \$3,000/kg in LEO will currently enable a launch company to reduce the overall price per kg to GEO. This is accomplished by launching a payload from Earth to LEO, then refueling using lunar propellant in LEO to boost it up to GEO or deeper into space. Since reusable and refuelable upper stage vehicles will likely be the first vehicles used to transport the propellant from the Moon to LEO, price points can be established for propellant in other locations. For example, in order to close the LEO business case, propellant must be purchased in LEO for \$3,000/kg or EML1 for \$1,000/kg or at the Moon for \$500/kg. Figure 70 shows a comparison of the cost of lunar propellant at various locations in cislunar space compared to the cost of propellant if launched from Earth. Note: as the cost to deliver propellant from Earth to LEO changes, the price of lunar propellant will have to adjust; ensuring that it is always offered at a competitive price relative to Earth sourced propellant.



**Figure 70: Cost of Propellant in Cislunar Space**

LEO demand is based on three refueled upper stage trips from LEO to GEO per year. It is estimated that each upper stage requires 70 tons of propellant. Using a large LO<sub>2</sub>/LH<sub>2</sub> in-space transport and lunar lander to deliver propellant from the Moon to LEO, it takes about 5 tons of propellant to transport 1 ton. That means one needs to produce 6 tons of propellant on the Moon for every ton needed in LEO. Note that aerobraking in Earth's atmosphere can reduce this by a factor of two (see Aerobraking/Aerocapture for LEO Delivery section). Finally, due to the fact that rocket engines burn LO<sub>2</sub>/LH<sub>2</sub> propellants in a mass ratio of approximately 5.35 to 1 and that water comes in the ratio of 8 to 1, one needs to mine about 1.5 tons of water for each ton of propellant, though eventually all that excess oxygen may have business value. Putting this all together, to support three super heavy flights per year, the plant needs to extract more than 1880 MT of water. Table 12 summarizes some of the key business parameters.

**Table 12: Key Parameters for the LEO Propellant Business Case**

Propellant delivered to LEO	210 MT /yr.
Price of propellant in LEO	\$3000/kg
Propellant produced on the Moon	1260 MT /yr.
Price of propellant on the Moon	\$500/kg
Quantity of ice mined on the Moon	1880 MT /yr.
Total annual value	\$630,000,000

Once the transportation architecture and early customers are established, the benefits of utilizing lunar propellant increase significantly. For example, the use of lunar propellant to refuel spacecraft moving from Earth to the lunar surface reduces the transportation cost by more than a factor of three (Figure 70). This can greatly enhance the affordability of NASA’s activities on the Moon and ESA’s Moon village. In addition, the lunar ice mining operation can provide water and oxygen to these activities as well as propellant. Lunar propellant is the first step in creating a vibrant cislunar economy. This infrastructure can be leveraged to dramatically lower the cost of both public and private activities within cislunar space and beyond.

**Mine Sizing<sup>158</sup>**

The LEO customer is currently willing to pay \$500/kg for propellant on the lunar surface, the lowest price that any of the customers within cislunar space are willing to pay. Compared to the lunar surface and EML1 customers, it is by far the most challenging business cases to close. To provide an initial conservative feasibility assessment, only the LEO customers’ economic requirements were used to derive top-level requirements for the mining operation itself. The most important requirement was determining that the total mass of the mine must be less than 40.5 tons [115]. The mass of the system determines both the cost to design and produce the hardware and the cost to deliver it to the lunar surface.

To meet the mass constraints with revenue generated only from the LEO customers business case, it was determined that the hardware production and development cost would need to be approximately \$50,000/kg [115]. Compared to current costs for commercial space hardware, there are cases where it can be developed for as low as \$30,000/kg (see Cost Reduction section), making the \$50,000/kg stated above within the realm of possibility. In addition, the LEO customer will likely be the last to market, following the lunar surface and EML1 customers. By that time, multiple iterations of lunar mining hardware will have been vetted, potentially further driving down the hardware production and development costs.

Recently, CSM developed three different concepts for a lunar mining operation that met the requirements of Table 12. The first option was a traditional excavation approach where icy regolith was removed by a backhoe, placed into an ore cart, moved to a centralized oven to heat and sublimate the ice. The second option employed a mobile driller to create boreholes in which heating elements were placed as described in the Active Extraction section. A tarp could be deployed across the surface to collect and refreeze the sublimated ice. The third option employed direct surface heating with the capture tent, CT subsystem that is the topic of the Passive Extraction sections. Table 13 shows the initial assessment of the three options.

**Table 13: Comparison of Ice Mining Options**

Parameter	Option 1 Excavation	Option 2 Drilling	Option 3 Passive
Mass (kg)	40400	31900	29000
Development cost (\$)	3.43B	2.71B	2.47B
Availability/ Maintainability	Medium	Medium-high	High
Risk	Low	Medium	Medium

<sup>158</sup> Section Author: George Sowers, Colorado School of Mines, Professor of Space Resources

## Economic Analysis<sup>159</sup>

### Discounted Cash Flow Model

An economic model was created in Excel to estimate the Net Present Value (NPV) of a lunar mining operation from the perspective of the mining company. This is done with a simple discounted cash flow model; beginning with the NRC or initial investment, and then the RC subtracted from the revenue for each year of operation. It is set up so that nearly all inputs can be changed to represent a variety of scenarios. These inputs include the discount rate, propellant demand and price, initial investment including hardware and launch costs, lifespan of the mine, and ground operations. A Graphical User Interface (GUI) was created for this tool and a screenshot can be seen below in Figure 71.

NPV is used in investment to indicate whether a venture is a promising (positive NPV) or a poor (negative NPV) investment. This model is only an estimate of the potential outcomes for a lunar mine. In order to make a more thorough analysis, considerations of risks, sources of investment, timeline, and policy, along with other influences, should be considered. In addition, the finite estimates used in this model represent a range of values that could be used. It is designed to handle updates as more refined data points are established.

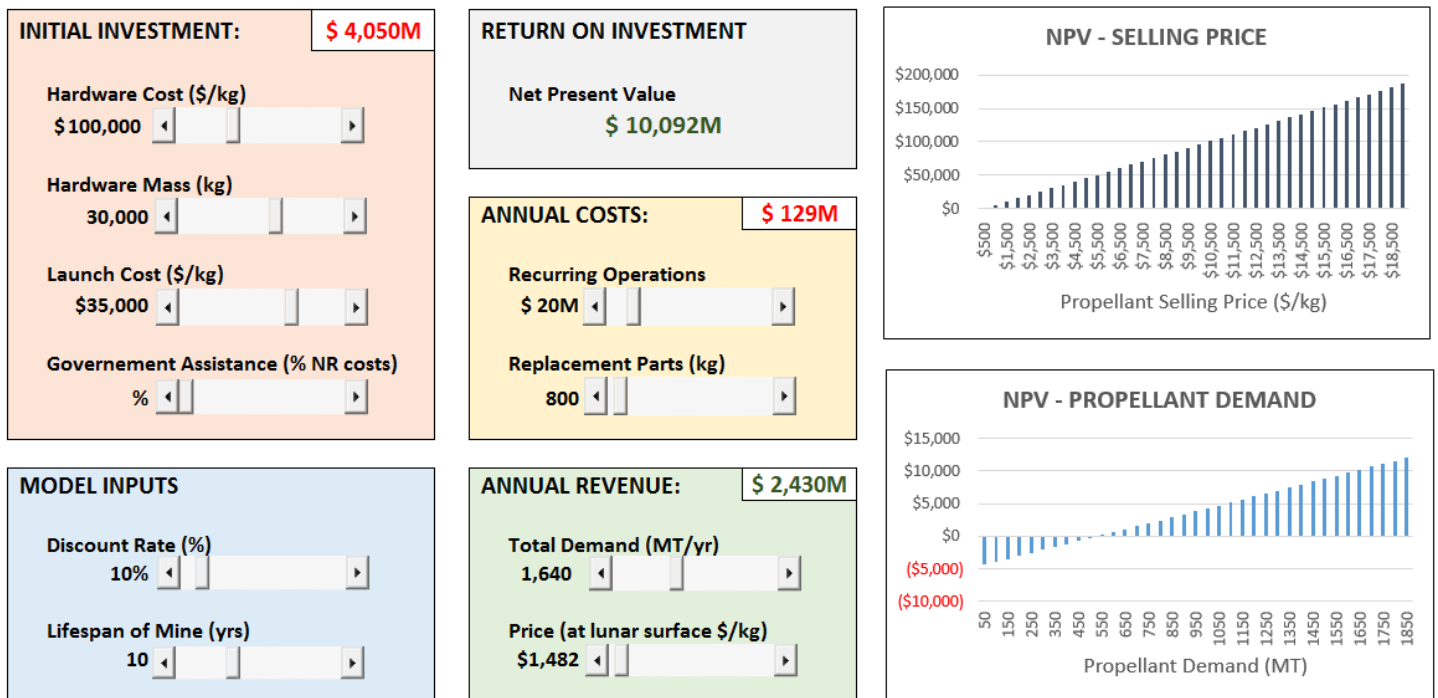


Figure 71: Screen-Shot of Economic Model GUI

### Seven Scenarios

Below examines seven different scenarios that represent possible customers, and combinations of customers, of lunar propellant. Each represents a different set of customers with varying demand and locations of use. As described in Propellant Pricing, the price of propellant varies depending on the location where it is being used. In all of these scenarios, the lunar mining hardware assumes a mass of 30,000 kg

<sup>159</sup> Section Authors: Erica Otto, United Launch Alliance, CisLunar Economic Analyst; David Kornuta, United Launch Alliance, CisLunar Project Lead

[116]<sup>160</sup> and costs \$100,000/kg to develop (double the rate used in the Mine Sizing section for a more conservative estimate). The value used for launch cost from the Earth to the lunar surface is \$35,000/kg [116]. This results in a total initial investment of roughly \$4 billion to establish the initial ISRU mining and processing capability. Annual costs include \$20 million for operations [117]<sup>161</sup> and 800 kg of replacement parts (estimate comparable to the ISS) [118]<sup>162</sup>. The hardware for the mine has a lifespan of 10 years. The outputs of these scenarios includes the total annual revenue, NPV and the Rate of Return (ROR). The discount rate used to calculate NPV was 10%. For cases with negative NPV, the amount that it is negative could also be viewed as the amount of subsidy that is required to close that business case for that scenario.

The first scenario considers customers in only one location: the Moon. As described in Lunar Surface and EML1 Customers, the Moon customer includes both the lunar surface and the NRHO customers. That customer is a reusable lunar cyler that delivers crew and cargo between a lunar orbital platform and the lunar surface. Based on the findings of this study, the values for this scenario are:

Scenario 1

- Customer location: Moon
- Demand on lunar surface: 100 MT per year
- Price of propellant on lunar surface: \$7,500/kg

The next scenario assumes that only the EML1 customers have come to market. In this case, the demand is primarily for refueling an interplanetary mission such as NASA’s journey to Mars with Lockheed Martin’s Mars Base Camp. In this scenario, the following values were used:

Scenario 2

- Customer location: EML1
- Demand on lunar surface: 280 MT per year
- Price of propellant on lunar surface: \$3,750/kg

The third scenario includes only LEO customers. These customers would include more traditional launch providers who have evolved the ability to refuel second stages in Earth orbit. This capability would enable substantially larger payloads to be delivered to GEO and beyond. In this case, the values used were:

Scenario 3

- Customer location: LEO
- Demand on lunar surface: 1,260 MT per year
- Price of propellant on lunar surface: \$500/kg

Scenario 4 is the first scenario that combines customers. These customers are located at different points within cislunar space so an average price of propellant had to be calculated. This was done with the following equation:

$$AVG\$Prop = \frac{Demand_{Cust1} * \$Prop_{Cust1} + Demand_{Cust2} * \$Prop_{Cust2} + Demand_{Custn} * \$Prop_{Custn}}{Demand_{Total}}$$

The combination of customers in this scenario included the LEO customers and the reusable lunar lander customers. The values used in this case are:

<sup>160</sup> [http://media.aero.und.edu/space.edu/documents/2018-0226\\_Sowers\\_Creating\\_the\\_Cislunar\\_Economy.pdf](http://media.aero.und.edu/space.edu/documents/2018-0226_Sowers_Creating_the_Cislunar_Economy.pdf)

<sup>161</sup> [https://www.nasa.gov/sites/default/files/atoms/files/fy\\_2018\\_budget\\_estimates.pdf](https://www.nasa.gov/sites/default/files/atoms/files/fy_2018_budget_estimates.pdf)

<sup>162</sup> <https://oig.nasa.gov/docs/IG-14-031.pdf>

#### Scenario 4

- Customer locations: LEO + Moon
- Demand on lunar surface: 1,360 MT per year
- Price of propellant on lunar surface: \$1,015/kg

Scenario 5 simulates the EML1 and LEO customers coming to market.

#### Scenario 5

- Customer locations: EML1 + LEO
- Demand on lunar surface: 1,540 MT per year
- Price of propellant on lunar surface: \$1,091/kg

Scenario 6 simulates the reusable lander and EML1 customers coming to market.

#### Scenario 6

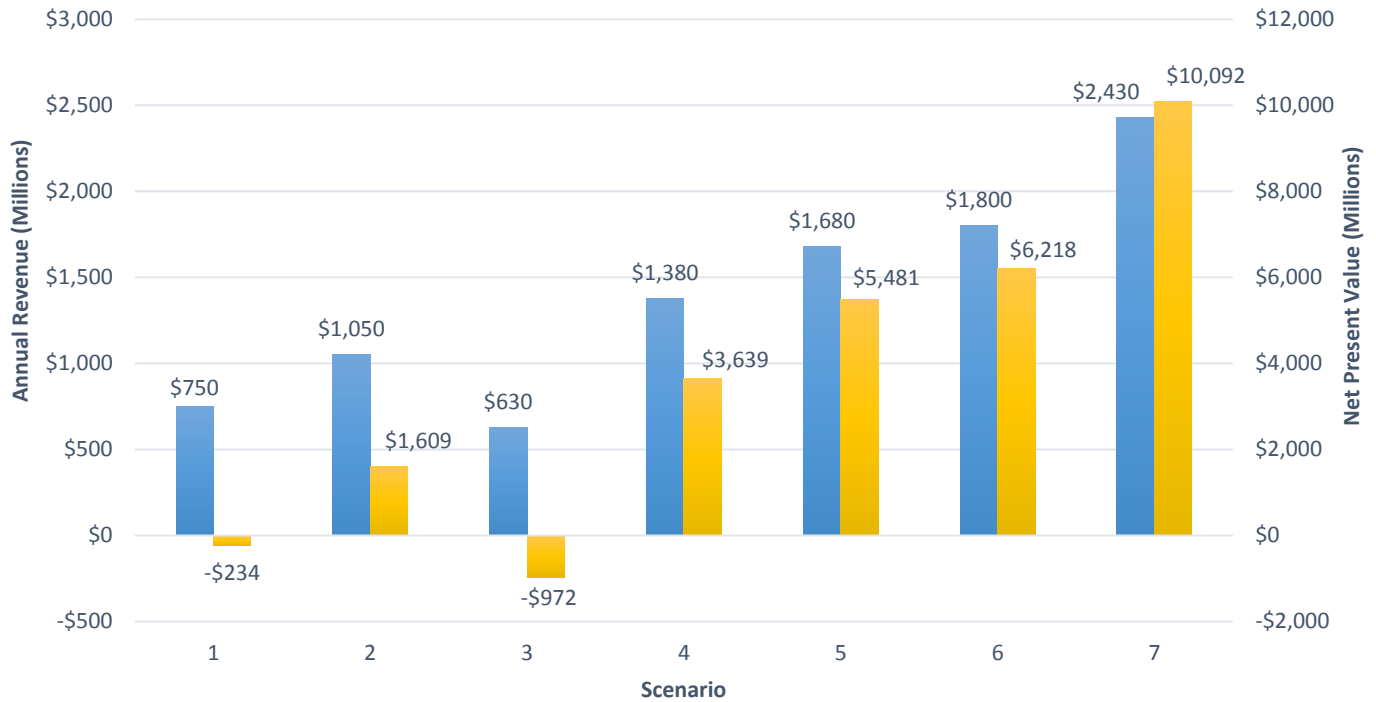
- Customer locations: Moon + EML1
- Demand on lunar surface: 380 MT per year
- Price of propellant on lunar surface: \$4,737/kg

Finally, scenario 7, the ideal scenario, combines all customers. This scenario represents a state where all customers estimated for this study come to market. In this case, there is the largest demand on the system and a wide variety of cislunar and deep space activities are underway. In this case, the following values were used:

#### Scenario 7

- Customer locations: Moon + EML1 + LEO (All Customers)
- Demand on lunar surface: 1,640 MT per year
- Price of propellant on lunar surface: \$1,482/kg

Figure 72 is a comparative plot of the revenue and NPV for all seven scenarios (blue bars indicate annual revenue and the gold bars indicate NPV). Using the data that was established during this study, it is apparent that many of the scenarios have positive NPV with a 10% discount rate and thus are viable investment opportunities. In fact, all scenarios that show multiple customers coming to market simultaneously have positive NPV. As stated before, the negative NPV for scenario 1 (Moon only) and scenario 2 (LEO only) does not necessarily kill the business case. What it implies is that in addition to the initial investment a subsidy, sponsorship or a lower discount rate would be required. This may be possible through a PPP, non-profit sponsorship or tax deductions.



**Figure 72: Revenue and NPV for Each Scenario**

Table 14 summarizes the inputs and outputs for the seven scenarios described above. Included is the ROR, which can also be thought of as the discount rate at which the NPV equals zero (breakeven point). So in scenario 1 and 2, where there is only the Moon customer or the LEO customer (which show negative NPV with a 10% discount rate), they could become viable investments if a tax deduction or lower interest rates reduced the discount rates to 9% or 4% respectively. This is even more apparent in Figure 73 that shows the relationship between NPV and the discount rate for the LEO-only business case. For that case, any rate less than 4% will produce a positive NPV.

**Table 14: Required Subsidy for Seven Scenarios**

Scenario	Customers	Demand (MT/yr @ LS)	AVG Prop Price (\$/kg @ LS)	Annual Revenue (\$M)	NPV (\$M)	ROR
1	Moon	100	\$7,500	\$750	-\$234	9%
2	EML1	280	\$3,750	\$1,050	\$1,609	19%
3	LEO	1260	\$500	\$630	-\$972	4%
4	LEO + Moon	1360	\$1,015	\$1,380	\$3,639	28%
5	EML1 + LEO	1540	\$1,091	\$1,680	\$5,481	37%
6	Moon + EML1	380	\$4,737	\$1,800	\$6,218	40%
7	All Customers	1640	\$1,482	\$2,430	\$10,092	56%



**Figure 73: LEO Business Case Discount Rate Sensitive**

In addition, decreasing the mass or the cost per kilogram of the required mining hardware, as described in the Mine Sizing section, would also drastically improve those business cases. With the establishment of multiple users, a lunar propellant production plant has the potential to be a viable commercial business endeavor. The business case has high margins, is technically feasible, and highly scalable. As the first customers of lunar propellant begin operations, the costs of in-space transportation will dramatically decrease, enabling entirely new types of business in space and opening up an age of space utilization for the benefit of all humankind.

**Business Risks<sup>163</sup>**

Business risks generally come in three categories: technology risks, performance risks and market risks. There are several technology risks for a lunar mining operation based on thermal mining as discussed in the Mining Operations section. Within the overall system architecture risks exist in nearly all subsystems but as the TRLs continue to increase, these risks are diminishing. In addition, to meet the 10-year lifetime requirement, a service and maintenance plan needs to be developed. In part, these risks will be addressed by a parallel research effort. Liquefaction into LO2/LH2 propellants is greatly aided by the extreme cold of the Permanently Shadowed Regions (PSR) of the Moon, though the extreme cold poses its own risks for equipment design and operation.

The highest risk specific to the thermal mining technology is the effectiveness and range of conditions under which thermal mining can yield the required ice sublimation rates. The most significant performance risk is in the cost estimate for the overall operation. Cost modeling, and various approaches, are explored in more detail in the Cost Modeling section below. In addition, it is recognized that a higher fidelity financial model is required to bolster adequate confidence for substantial investment. This is explored further on in the Strategize for Investment Appeal section. The market risk is also substantial at this time since few propellant customers have yet proposed a demand and price point. As other customers come to market, such as NASA and those described in the Customers section, this risk will be substantially reduced. The following section, Historic Market Research, will consider past market research that has been conducted for lunar resource products. Much of this uncertainty will subside as we see NASA’s plans for lunar and Mars activities mature and with the fielding of required lunar propellant architecture components.

<sup>163</sup> Section Author: George Sowers, Colorado School of Mines, Professor of Space Resources



## Historic Market Research<sup>164</sup>

The following section contains a collection of work that has been conducted independent of this study in support of lunar ISRU. The wealth of knowledge that has been accumulated in these historic studies has helped form the foundation of our current understanding of lunar resource utilization. This information represents a multi-decadal research effort that has been conducted on the subject.

The Commercial Space Transportation Study (CSTS) [119]<sup>165</sup> was a collaborative effort in the early 1990s between all of the major aerospace companies and NASA to take a close look at existing markets and the likelihood of emerging markets for space launch. The primary focus was on forecasting commercial trends and estimating demand elasticity. The study examined how much demand might grow if lower launch prices became available, projecting the total number of flights per year by summing individual market segments. While mostly focused on Earth launch markets, CSTS was an early attempt to quantify the potential launch market related to space utilities, asteroid exploration & detection, multi-use LEO business parks, space settlements and space manufacturing as well as lunar surface applications such as government exploration, nuclear waste storage, settlements and lunar power. Results from this study can be seen in Table 15.

**Table 15: On-orbit and Planetary Surface Markets Envisioned in 1994 CSTS**

	MBS Item	Time Frame (modeled markets in bold)			Market Description
		Short-Term	Medium-Term	Long-Term	
1	<b>Communications Market (commercial)</b>				
1	Fixed Satellite Service	X	X	X	Orbital Transfer (Deployment)
2	Direct Broadcast Service	X	X	X	Orbital Transfer (Deployment)
2	<b>Space Manufacturing</b>				
1	Manufacturing			X	Feedstock, Construction Materials
2	In-Space Processing		X	X	Mineral Feedstock
3	<b>Government Missions</b>				
1	Existing Government Missions				
1	NASA Missions (Excluding Station)	X			Orbital Transfer (Deployment)
2	DOD Missions	X			Orbital Transfer (Deployment + Missions)
2	Increased Space Station Missions				
1	Station Deployment		X	X	Orbital Transfer
2	Station Resupply	X	X	X	Life Support
3	Station Reboost		X	X	Stationkeeping
3	Human Planetary Exploration				
1	Lunar Base Program			X	Orbital Transfer, Life Support, Construction Materials
2	Mars Design Reference Missions		X	X	Orbital Transfer, Life Support
3	Asteroid Exploration			X	Orbital Transfer, Life Support
4	Asteroid Detection/Negation (robotic)		X	X	Orbital Transfer (Deployment + Missions)
5	Technology Development Testbed	X	X	X	Experimental (e.g., DARPA Orbital Express program)
4	<b>Transportation</b>				
1	Space Servicing	X	X	X	Orbital Transfer (Deployment + Missions)
2	Hazardous Waste Disposal			X	Orbital Transfer (Deployment)
3	Space Tourism		X	X	Orbital Transfer, Life Support
5	<b>New Missions</b>				
1	Space Debris Management	X	X	X	Orbital Transfer (Deployment + Missions)
2	Multiuse LEO Business Park		X	X	Stationkeeping, Life Support
3	Space Settlements			X	Construction Materials, Life Support, Fuels
6	<b>Space Utilities</b>				
1	GEO Solar Power Satellites		X	X	Orbital Transfer (Deployment), Construction Materials
2	Lunar Based Power Station			X	Construction Materials
3	Space to Space Power Beaming			X	Orbital Transfer (Deployment), Construction Materials

<sup>164</sup> Section Author: Brad Blair, New Space Analytics, Managing Partner

<sup>165</sup> <http://www.hq.nasa.gov/webaccess/CommSpaceTrans/>

In 2002, the NASA Exploration Team (NExT) funded economic research on lunar ice mining, solving for feasibility criteria that would attract private investment [120]<sup>166</sup>. The ISRU technical architecture was based on the Eagle Engineering parametric lunar mining system models developed in 1988 [121]<sup>167</sup>. The market model was based on annual launch of geosynchronous satellites detailed by Smitherman [122]<sup>168</sup>. A reusable transfer stage was scaled to deliver commercial payloads from LEO to GEO competing with expendable terrestrial upper stages and refueled at EML1. These inputs were used to develop a parametric engineering model of a modular, scalable commercial space architecture designed to meet demand. Costing of the engineering model used the NASA and Air Force Cost Model (NAFCOM) to estimate life cycle and operations costs through the life of the commercial architecture. Price that a hypothetical customer would be “willing to pay” was based on what it would cost terrestrial competition to operate the same service. Feasibility conditions were then mapped as a function of variations in cost, market size and ice concentration, solving for conditions that would attract private investment assuming the project was a typical terrestrial mining venture. The financial model generated pro forma financial statements, calculated the amount of capitalization required, and generated return on equity calculations using two valuation metrics of direct interest to private investors: market enterprise value and multiples of key financial measures. Unit costs for propellant at the lunar surface, EML1 and LEO were then estimated as a function of time using annual cost and system throughput as shown in Table 16 below [120].

**Table 16: Production Levels and Unit Costs for Lunar Propellant**

Year	2009	2010	2011	2012	2013	2014	2015	2016
Tons Produced - Moon	0	470	941	1411	1881	2822	3762	4703
Tons Delivered - L1	0	216	432	648	864	1296	1729	2161
Tons Delivered - LEO	0	134	267	401	535	802	1069	1337
CAPEX	\$ 1,587	\$ 2,998	\$ 2,993	\$ 2,394	\$ 1,923	\$ 3,670	\$ 4,127	\$ 3,880
CAPEX+Int	\$ 1,587	\$ 3,077	\$ 3,216	\$ 2,716	\$ 2,285	\$ 4,029	\$ 4,455	\$ 4,151
CAPEX+Int+prin	\$ 1,587	\$ 3,077	\$ 3,216	\$ 2,716	\$ 2,285	\$ 5,341	\$ 5,546	\$ 4,718
CAPEX+Int+prin+Tax	\$ 1,587	\$ 3,244	\$ 3,490	\$ 3,130	\$ 2,881	\$ 6,343	\$ 6,791	\$ 6,536
Cost/ton - Moon (\$M/t)		\$ 6.90	\$ 3.71	\$ 2.22	\$ 1.53	\$ 2.25	\$ 1.81	\$ 1.39
Cost/ton - L1 (\$M/t)		\$ 15.01	\$ 8.08	\$ 4.83	\$ 3.33	\$ 4.89	\$ 3.93	\$ 3.03
Cost/ton - LEO (\$M/t)		\$ 24.27	\$ 13.05	\$ 7.80	\$ 5.39	\$ 7.91	\$ 6.35	\$ 4.89

An interdisciplinary team from CSM, Florida Institute of Technology, NASA-JSC, NASA-KSC and Northern Centre for Advanced Technology (NORCAT) from Sudbury, Ontario conducted the Space Transportation Architectures and Refueling for Lunar and Interplanetary Travel and Exploration (STARLITE) study in 2004 [123]. The work was funded by the Revolutionary Aerospace Systems Concepts (RASC) program, which had already developed the Orbital Aggregation of Space Infrastructure Systems (OASIS) reusable space transportation point designs for solar-electric and chemical transportation vehicles, a hybrid propellant transfer module and human-tended EML1 transportation gateway for staging human missions to the Moon, Mars and asteroids [124]<sup>169</sup>. STARLITE modeled and costed the systems elements mentioned above and developed engineering estimates for ISRU hardware for the resources of the Moon, Phobos and Mars. Products modeled for the lunar case included propellant, water, glass, nitrogen and power supplied at the lunar surface. Unit costs for each of these elements through the study period are shown in Table 17 [123] below.

<sup>166</sup> [http://www.isruinfo.com/docs/LDEM\\_Draft4-updated.pdf](http://www.isruinfo.com/docs/LDEM_Draft4-updated.pdf)

<sup>167</sup> <https://ntrs.nasa.gov/archive/nasa/casi.ntrs.nasa.gov/19890004515.pdf>

<sup>168</sup> <https://ntrs.nasa.gov/archive/nasa/casi.ntrs.nasa.gov/20020016967.pdf>

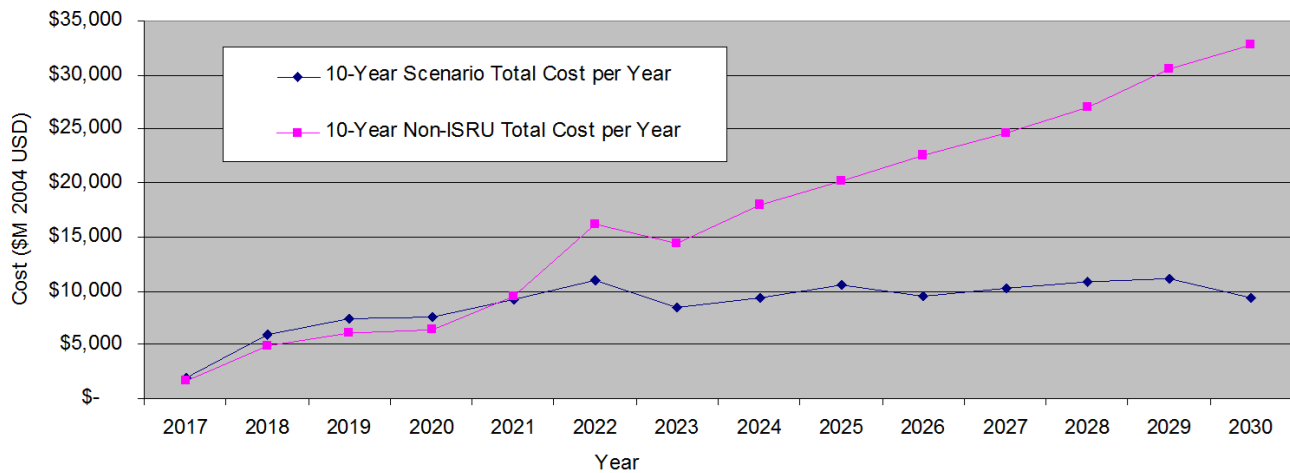
<sup>169</sup> [https://spacecraft.ssl.umd.edu/old\\_site/academics/484S03/oasis\\_docs/OASIS\\_FY01\\_FINAL.PDF](https://spacecraft.ssl.umd.edu/old_site/academics/484S03/oasis_docs/OASIS_FY01_FINAL.PDF)

**Table 17: Development of Unit Costs for STARLITE 10-yr Lunar Architecture**

ISRU SYSTEM MASS RATIOS (relative to total cumulative arch mass)										
Year	2021	2022	2023	2024	2025	2026	2027	2028	2029	2030
Nitrogen Plant Mass Ratio	0.0%	0.4%	0.6%	0.7%	0.7%	0.8%	0.8%	0.8%	0.8%	0.8%
Nuclear Power Mass Ratio	2.3%	4.1%	3.1%	2.4%	1.8%	1.5%	1.3%	1.1%	1.0%	0.9%
Solar Power Mass Ratio	1.7%	11.3%	12.8%	13.2%	13.1%	13.6%	13.9%	14.3%	14.6%	15.3%
Lunar Water Mass Ratio	9.0%	8.6%	7.3%	7.0%	7.5%	8.1%	8.5%	8.7%	10.0%	10.1%
L1 Water Mass Ratio	10.3%	9.4%	7.7%	6.5%	7.6%	8.7%	8.4%	9.3%	10.6%	10.8%
Glass Plant Mass Ratio	1.3%	0.5%	0.4%	0.3%	0.2%	0.2%	0.2%	0.1%	0.1%	0.1%
Crew Support Mass Ratio	39.6%	31.6%	33.0%	32.5%	30.2%	29.9%	29.7%	29.2%	28.7%	29.4%
Crew Transport Mass Ratio	35.8%	34.1%	35.1%	37.4%	38.8%	37.3%	37.2%	36.3%	34.1%	32.5%
ANNUAL COSTS INCL. AMORTIZATION										
Annual Program Cost (\$M)	\$ 9,135	\$ 10,985	\$ 8,414	\$ 9,401	\$ 10,477	\$ 9,478	\$ 10,167	\$ 10,888	\$ 11,051	\$ 9,408
Amortized Development & Predeployment	\$ 2,283	\$ 2,283	\$ 2,283	\$ 2,283	\$ 2,283	\$ 2,283	\$ 2,283	\$ 2,283	\$ 2,283	\$ 2,283
Annual Program Cost incl. Amortization	\$ 11,418	\$ 13,268	\$ 10,697	\$ 11,684	\$ 12,760	\$ 11,761	\$ 12,450	\$ 13,171	\$ 13,334	\$ 11,691
ISRU SYSTEM COST SHARE										
Nuclear Power	\$ 267	\$ 543	\$ 327	\$ 275	\$ 228	\$ 176	\$ 161	\$ 148	\$ 132	\$ 107
Solar Power	\$ 194	\$ 1,502	\$ 1,370	\$ 1,538	\$ 1,674	\$ 1,596	\$ 1,730	\$ 1,890	\$ 1,942	\$ 1,793
Nitrogen Plant	\$ -	\$ 56	\$ 68	\$ 85	\$ 94	\$ 91	\$ 100	\$ 107	\$ 109	\$ 89
Lunar Water / propellant	\$ 1,030	\$ 1,137	\$ 784	\$ 821	\$ 954	\$ 950	\$ 1,059	\$ 1,150	\$ 1,337	\$ 1,185
L1 Water / propellant	\$ 1,174	\$ 1,242	\$ 828	\$ 761	\$ 975	\$ 1,020	\$ 1,048	\$ 1,221	\$ 1,419	\$ 1,258
Glass Plant	\$ 150	\$ 71	\$ 43	\$ 36	\$ 30	\$ 23	\$ 21	\$ 19	\$ 17	\$ 14
CREW SYSTEM COST SHARE										
Crew Support	\$ 4,517	\$ 4,192	\$ 3,527	\$ 3,797	\$ 3,848	\$ 3,517	\$ 3,701	\$ 3,852	\$ 3,827	\$ 3,442
Crew Transportation	\$ 4,087	\$ 4,524	\$ 3,751	\$ 4,370	\$ 4,956	\$ 4,387	\$ 4,630	\$ 4,784	\$ 4,551	\$ 3,803
Number of Crew	10	20	30	40	50	60	70	80	90	100
SYSTEM UNIT COSTS (using mass proportional cost share)										
Nuclear Power (\$M/kw)	\$ 0.67	\$ 1.09	\$ 0.65	\$ 0.55	\$ 0.46	\$ 0.35	\$ 0.32	\$ 0.30	\$ 0.26	\$ 0.21
Solar Power (\$M/kw)	\$ 0.24	\$ 0.83	\$ 0.49	\$ 0.40	\$ 0.33	\$ 0.26	\$ 0.23	\$ 0.21	\$ 0.19	\$ 0.15
Nitrogen (\$M/ton)	\$ -	\$ 56.15	\$ 33.85	\$ 28.39	\$ 23.56	\$ 18.23	\$ 16.64	\$ 15.29	\$ 13.59	\$ 11.06
Lunar Water / propellant (\$M/ton)	\$ 3.73	\$ 1.83	\$ 1.07	\$ 0.89	\$ 0.79	\$ 0.61	\$ 0.56	\$ 0.52	\$ 0.47	\$ 0.38
L1 Water / propellant (\$M/ton)	\$ 12.67	\$ 5.22	\$ 3.29	\$ 2.47	\$ 1.91	\$ 1.53	\$ 1.27	\$ 1.24	\$ 1.08	\$ 0.88
Glass (\$M/ton)	\$ 1.40	\$ 0.66	\$ 0.40	\$ 0.33	\$ 0.28	\$ 0.21	\$ 0.20	\$ 0.18	\$ 0.16	\$ 0.13
Crew Support (\$M/crewmember)	\$ 451.68	\$ 209.60	\$ 117.58	\$ 94.94	\$ 76.96	\$ 58.62	\$ 52.87	\$ 48.15	\$ 42.52	\$ 34.42
Crew Transportation (\$M/crewmember)	\$ 408.71	\$ 226.19	\$ 125.02	\$ 109.25	\$ 99.12	\$ 73.12	\$ 66.14	\$ 59.80	\$ 50.57	\$ 38.03

Economic analysis included systems-level, operational and life cycle costing, and modeled the costs and benefits of ISRU vs. an all-expendable baseline for steady-state human missions to the Moon and Mars [123]. It is evident from Figure 74 [123] below that lunar-derived propellant can linearize the rocket equation. While the work examined cost-benefit ratios from both a technical and economic perspective, the modeling of commercial investment conditions was not undertaken.

**Comparison of ISRU vs. All Expendable for 10-Year Lunar Architecture**



**Figure 74: Linearization of the Rocket Equation Due to Lunar ISRU**

During the NASA Concept Evaluation and Refinement (CE&R) program in 2005, four industry teams developed human exploration architectures that included a strong role for ISRU. The t-Space architecture assumed a high level of early commercial involvement, showing economic results that suggested that the required government expenditures for lunar base implementation could be sharply reduced through a PPP [125]<sup>170</sup>. The results of CE&R expanded the growing diversity of architectural options regarding technology, transportation, operations, procurement systems, risk, and program management for a human lunar return.

In 2007, an economic analysis was performed by Spaceworks of Atlanta, Georgia of a hypothetical company that produces propellant and oxygen on the lunar surface. Detailed market and cost analysis of lunar propellant was performed for customers on the lunar surface, in LLO and GEO. Results of this study can be seen in Table 18 [126]<sup>171</sup>.

**Table 18: Cost and Market Demand for Spaceworks SMR Model**

Case #	Product(s)	Demand	Case Description
1A*	Propellant on Lunar Surface	49.4 MT/yr	The commercial provider of ISRU propellant sells its maximum production capacity each year to government and/or commercial buyers on the Lunar surface.
1B	Propellant on Lunar Surface Oxygen on Lunar Surface	49.4 MT/yr 19.7 MT/yr	Case 1A plus excess oxygen produced is sold to government and/or commercial buyers on the Lunar surface.
2A*	Propellant to LLO	21.0 MT/yr	The commercial provider of ISRU propellant delivers and sells only the amount of propellant demanded by a government customer in LLO.
2B	Propellant to LLO Oxygen on Lunar Surface	21.0 MT/yr 22.5 MT/yr	Case 2A plus excess oxygen produced is sold to government and/or commercial buyers on the Lunar surface.
2C	Propellant to LLO Oxygen on Lunar Surface Propellant on Lunar Surface	21.0 MT/yr 19.7 MT/yr 3.3 MT/yr	Case 2B plus excess propellant not demanded by the government is sold to a government and/or commercial customer on the Lunar surface.
3A	Propellant to GEO	0.45 MT/yr	The commercial provider of ISRU propellant delivers and sells only the amount of propellant demanded by a commercial satellite tug operator in GEO.
3B	Propellant to GEO Oxygen on Lunar Surface	0.45 MT/yr 51.2 MT/yr	Case 3A plus excess oxygen produced is sold to government and/or commercial buyers on the Lunar surface.
3C	Propellant to GEO Oxygen on Lunar Surface Propellant on Lunar Surface	0.45 MT/yr 19.7 MT/yr 37.2 MT/yr	Case 3B plus excess propellant not demanded by the GEO satellite tug operator is sold to a government and/or commercial customer on the Lunar surface.

\*Probabilistic results presented for Case 1A and Case 2A

Demand scenarios were developed for three cases. Case 1 modeled the sale of propellant and oxygen on the lunar surface to government and/or commercial buyers. Case 2 modeled the sale of propellant to a government customer in LLO to support a reusable lander for a human exploration program. Case 3 examined sale of propellant to a commercial customer in GEO. Costs, revenues and breakeven prices are shown in Table 19 [126] below.

<sup>170</sup> [https://www.nasa.gov/missions/solarsystem/vision\\_concepts.html](https://www.nasa.gov/missions/solarsystem/vision_concepts.html)

<sup>171</sup> <http://www.sei.aero/eng/papers/uploads/archive/IAC-07-A5.1.03.pdf?>

**Table 19: Costs, Revenues and Breakeven for Spaceworks Lunar ISRU Model**

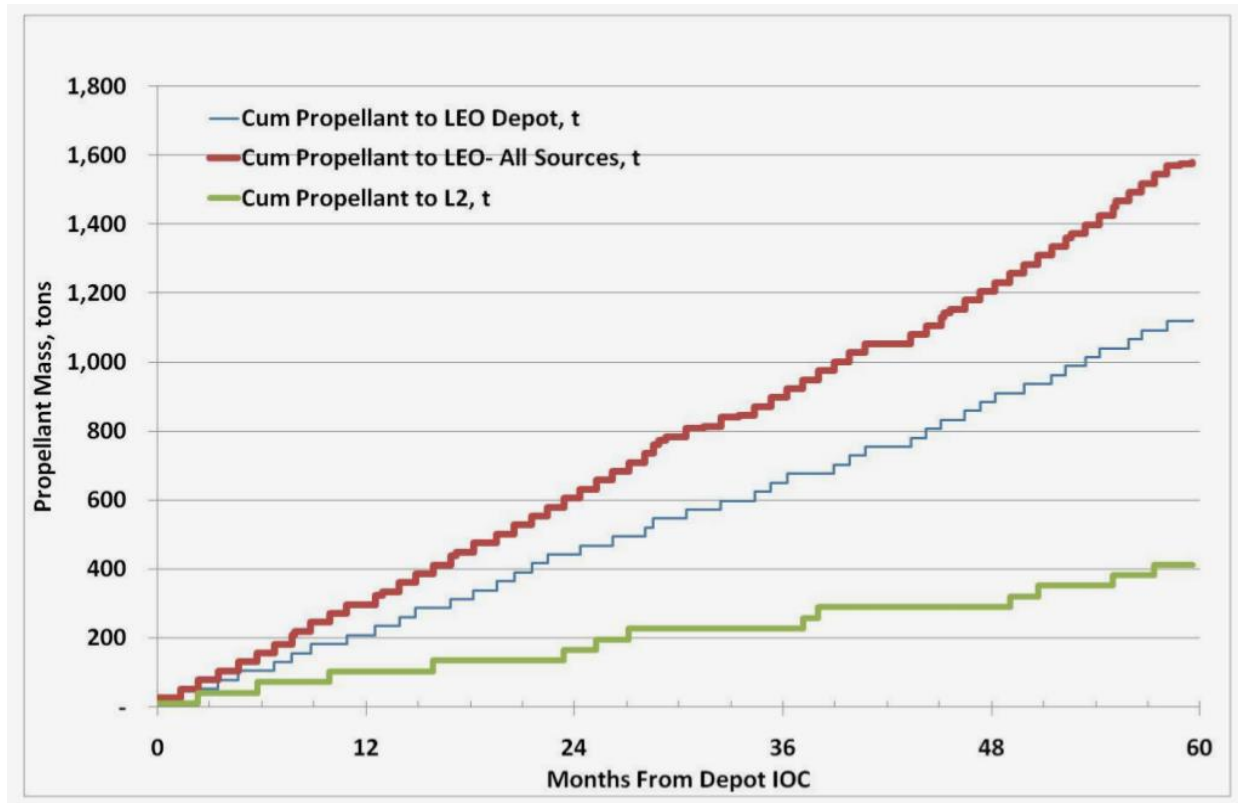
Case	Point of Sale of Product(s)	Price for Propellant for WACC = 21.7% {For Only Cost with Inflation}	Price for Excess Oxygen on Lunar Surface for WACC = 21.7% {For Only Cost with Inflation}	Price for Excess Propellant on Lunar Surface for WACC = 21.7% {For Only Cost With Inflation}
1A	Propellant on Lunar Surface	\$26,845 per kg { \$7,327 per kg }	-	-
1B	Propellant on Lunar Surface Oxygen on Lunar Surface	\$25,571 per kg { \$6,979 per kg }	\$3,196 per kg { \$872 per kg }	-
2A	Propellant to LLO	\$133,947 per kg	-	-
2B	Propellant to LLO Oxygen on Lunar Surface	\$126,243 per kg { \$31,056 per kg }	\$7,188 per kg { \$1,768 per kg }	-
2C	Propellant to LLO Oxygen on Lunar Surface Propellant on Lunar Surface	\$119,019 per kg { \$29,279 per kg }	\$6,777 per kg { \$1,667 per kg }	\$54,216 per kg { \$13,337 per kg }
3A	Propellant to GEO	\$7,053,265 per kg	-	-
3B	Propellant to GEO Oxygen on Lunar Surface Propellant to GEO	\$4,632,347 per kg	\$21,294 per kg	-
3C	Oxygen on Lunar Surface Propellant on Lunar Surface	\$1,663,560 per kg	\$7,647 per kg	\$61,175 per kg

Detailed information on the role for ISRU in human Moon and Mars exploration architectures was presented in the Spaceworks study above. Indeed, NASA’s enabling role in ‘priming the pump’ for the lunar propellant ‘oil well’ is emerging as a leading early application for ISRU system maturation from both the technical as well as economic perspective. This has been well documented in a growing number of studies.

In addition to studies that directly address lunar resources, there are also relevant studies that identify critical technologies needed for ISRU realization. Spurred by the prospect of spacecraft reusability, in-space fuel depots supplied by terrestrially launched propellants offer near-term technical and logistical benefits that could dramatically increase the effectiveness of payload delivery [127]<sup>172</sup> and ultimately, support future lunar propellant distribution. Figure 75 represents the estimated usage of a notional propellant depot. This fits well with a strategy of incremental technology development toward a mature propellant supply capability.

*"The benefits of this very basic LEO depot as well as subsequent EML1 or EML2 based depots are shown for missions other than lunar landings. These range from robotic advanced capability probes to virtually anywhere in the solar system to more ambitious manned missions to near Earth asteroids and the Moon." [127]*

<sup>172</sup> <https://www.ulalaunch.com/docs/default-source/exploration/evolving-to-a-depot-based-space-transportation-architecture.pdf>



**Figure 75: Propellant Forecast for LEO and L2**

Once terrestrially supplied depots have been tested and certified for use, transitioning to space-based propellants derived from lunar or asteroid resources will be straightforward - reducing risk and building a customer base. Users are likely to be agnostic about propellant source, focusing on price as their primary decision variable in the end. In addition, the maximum price that a space entrepreneur could negotiate with a customer will be limited by the cost of obtaining outbound terrestrial fuel. This insight is fundamental to understanding how both the marketplace for propellants in cislunar space will evolve and how private investment will chase future economic rewards.

### Cost Modeling<sup>173</sup>

Similar to an engineering model, cost models can be developed at various levels of detail. For a first round of analysis, the cost model could be as simple as a Cost-Estimating Relationship (CER) – a linear model with or without a zero intercept (typically in thousands of dollars per kg). More sophisticated CERs can include dry mass for development and production cost, wet mass for launch cost, and number of elements for operations cost. Simple, back of the envelope (low-TRL) designs can be estimated this way, with the understanding that they will have a high degree of uncertainty. More detailed parametric-equation-based engineering design estimates can utilize analogy-based methods, adding detail and auto-scaling to conduct sensitivity analysis more easily. This provides not only the required flexibility to quickly adapt to changing design space and identify sweet spots, but also can provide the required inputs needed to begin cost risk analysis. Finally, high-fidelity engineering design graduates to bottoms-up cost estimates that track each piece of hardware along with its integration and operational requirements, minimizing cost

<sup>173</sup> Section Author: Brad Blair, NewSpace Analytics, Managing Partner

uncertainty. This of course assumes that manufacturing costs are well behaved and predictable. This may not be the case yet for ISRU technology.

As of today, many of the system level models of ISRU architectures are CERs; however, as the maturity of subsystem ISRU hardware continues to increase, subsystem developers will generate higher-fidelity cost models. Because the subsystems are being developed by such a diversity of companies and industries, it will require an integrator to stitch the high-fidelity models together to create the most accurate cost model of an overarching ISRU architecture. This is the next step to close the business case for a lunar propellant production plant. Coordination on this scale has been demonstrated by both government organizations and commercial ventures. In particular, those for large civil infrastructure and remote resource mining.

### Historical ISRU Cost Estimates

A good starting point for understanding the costs of integrated ISRU equipment is examining the prior cost estimation art. It is also important to remember that to date nobody has ever flown an ISRU mission. In fact, the most advanced TRLs for integrated ISRU systems (at least the ones that are publically known) are generally less than five. A quick survey of prior art in cost estimates for lunar surface ISRU systems include Erickson (1988) [128]<sup>174</sup>, Blair (2002) [120]<sup>175</sup>, Charania (2007) [126]<sup>176</sup>, Spudis (2011) [129]<sup>177</sup> and Lavoie (2016) [130]<sup>178</sup>. A summary of the results of some of these studies can be seen in Table 20. Note that inflation adjustments were not made - the financial year for dollar estimates is the same as the publication year. Note that work that is more recent had extended these kinds of results to Mars ISRU.

**Table 20: Cost Modeling Results from Various ISRU Studies**

Published ISRU Cost Estimates	ore type	Mining & Hauling			Processing Plant + Storage					Power Plant			
		mass	dev	cost/mfg cost	ISRU plant type	kg/yr	mass	dev	cost/mfg cost	type	mass	dev	cost
Blair (2002)	polar ice	630	47.2	33.2	ice heating & electrolysis	245000	7134	771	54.5	nuclear	3421	565	341
Charania (2007)	unspecified	2600	162	54	unspecified	57600	5910	595	198	nuclear	5400	200	67
Spudis (2011)	polar ice	2300	1065	725	ice heating & electrolysis	30000	2400	4420	1400	solar	1100	n/s	n/s
Lavoie (2016)	polar ice	4000	350	250	ice heating & electrolysis	140000	5000	1000	250	solar	1900	n/s	785

Methods used for estimates in the Table 20 include both CERs and Analogy-based methods. Due to a general lack of direct ISRU system flight experience, the highest fidelity method for predicting costs so far has been the use of analogy-based methods. NAFCOM provides a useful tool to estimate the costs a government-led or managed enterprise would most likely experience using ‘business as usual’ design, fabrication, operations and procurement methods based on an analogy to prior flight systems and procurement experience. This was done in a NASA funded study at the CSM in 2002 [120].

*“NAFCOM99 was utilized to estimate the costs of development and production at the systems level for elements of each of the architectures. The masses derived from the architecture analysis were input into NAFCOM along with analogies appropriate for the current level of analysis. ... Operations costs [were] modeled at the systems level using the Space Operations Cost Model (SOCM). ... Finally, the economic model assumes that 10% of subsystems (and 1% of tanks) must be replaced each year.” [120]*

<sup>174</sup> <https://ntrs.nasa.gov/search.jsp?R=19890005915>

<sup>175</sup> [http://www.isruinfo.com//docs/LDEM\\_Draft4-updated.pdf](http://www.isruinfo.com//docs/LDEM_Draft4-updated.pdf)

<sup>176</sup> <http://www.sei.aero/eng/papers/uploads/archive/IAC-07-A5.1.03.pdf>

<sup>177</sup> <http://www.spudislunarresources.com/Bibliography/p/102.pdf>

<sup>178</sup> <http://dx.doi.org/10.2514/6.2016-5526>, <http://www.spudislunarresources.com/Bibliography/p/118.pdf>

Note that in order to focus study effort on cost, market and economic aspects of lunar ISRU, the Fiscal Year (FY) 02 cost estimates shown in Table 21 [120] below adopted the parametric mining architecture from Christiansen [121]<sup>179</sup> as a technical baseline. The work combined a low-fidelity mining model, a medium-fidelity cost model with a high-fidelity financial model. The specific analogies that were used are shown in the Table 21. High-cost programs with unique requirements were carefully selected in order to build a ‘conservative’ model that would represent the highest-cost government-integrated procurement methodology in order to provide an upper bound on potential future enterprise costs [120]. The model would relax that assumption in order to solve for the feasibility conditions under which a private investor would make a sufficient return on investment and actually invest.

**Table 21: Estimated cost vs. Analogy for Lunar ISRU Elements**

FY02 SRD Architecture 2a Cost Estimate (imported)	Cost Breakdown (\$M USD FY02)						Wt - lbs	Analogy
	Mass (kg)	D&D	STH	FU	Prod	Total Cost		
Brad R. Blair, Colorado School of Mines								
<b>GRAND TOTAL</b>	<b>37470.2</b>	<b>5393.2</b>	<b>1018.1</b>	<b>1264.5</b>	<b>1264.5</b>	<b>7675.8</b>	<b>82608.0</b>	
SYSTEM 1: Lunar Surface Mining & Processing Equipment	13980.7	3972.1	750.5	927.1	927.1	5649.7	30822.3	
<b>HARDWARE TOTAL</b>	<b>13980.7</b>	<b>1861.6</b>	<b>750.5</b>	<b>577.3</b>	<b>577.3</b>	<b>3189.5</b>	<b>30822.3</b>	
Regolith Excavator	274.0	19.5	17.7	13.6	13.6	50.8	604.1	Mars Pathfinder - Structural/Mechanical Group
Structure	68.5	8.2	5.7	4.4	4.4	18.3	151.0	Mars Pathfinder - Structural/Mechanical Group
Mobility	68.5	3.9	6.4	4.9	4.9	15.3	151.0	Mars Pathfinder - Mechanisms Subsystem
Excavation	68.5	0.8	1.4	1.1	1.1	3.3	151.0	DSCS-III A - Wheel, Reaction
Soil Handling	65.5	6.1	3.7	2.8	2.8	12.6	144.4	Mars Pathfinder - Structural/Mechanical Group
CC&DH	3.0	0.5	0.4	0.3	0.3	1.3	6.6	Lunar Prospector - CC&DH Group
Regolith Hauler	356.0	27.7	25.5	19.6	19.6	72.8	784.8	Mars Pathfinder - Structural/Mechanical Group
Structure	117.7	10.0	6.7	5.2	5.2	22	259.5	Mars Pathfinder - Structures Subsystem
Mobility	117.7	5.3	9.3	7.2	7.2	21.8	259.5	Mars Pathfinder - Mechanisms Subsystem
Soil Handling	117.6	11.0	8.3	6.4	6.4	25.8	259.3	Mars Pathfinder - Structural/Mechanical Group
CC&DH	3.0	1.3	1.1	0.9	0.9	3.3	6.6	ATS-6 - CC&DH Group
Thermal Extraction	2736.9	602.3	24.1	18.5	18.5	644.8	6034.0	Centaur-D - Propulsion Subsystem
Water Electrolysis	736.0	90.6	38.2	29.4	29.4	158.2	1622.6	Shuttle Orbiter - Generation, Electrical Power
Hydrogen Liquefier	25.0	2.9	0.6	0.4	0.4	3.9	55.1	OMV - Heat Pipes/Cold Plate
Hydrogen Liquefier Radiators	425.0	26.9	1.6	1.3	1.3	29.8	936.9	Centaur-D - Thermal Control Subsystem
Oxygen Liquefier	92.0	5.6	1.6	1.2	1.2	8.4	202.8	OMV - Heat Pipes/Cold Plate
Oxygen Liquefier Radiators	131.0	14.9	0.6	0.5	0.5	16.1	288.8	Centaur-D - Thermal Control Subsystem
Water Tanks	520.0	7.0	1	0.8	0.8	8.7	1146.4	Centaur-G' - Tank
Hydrogen Tanks	469.0	6.6	0.9	0.7	0.7	8.2	1034.0	Centaur-G' - Tank
Oxygen Tanks	1999.0	14.6	2.2	1.7	1.7	18.6	4407.0	Centaur-G' - Tank
Power System (Nuclear)	3420.9	565.1	442.7	340.5	340.5	1348.3	7541.9	Galileo Orbiter - Electrical Power and Dist Group
Maintenance Facility	1000.0	374.1	152.6	117.4	117.4	644	2204.6	Mars Pathfinder - CC&DH + Mechanisms
Mobility	200.0	78.9	10.4	8.0	8.0	97.3	440.9	Lunar Rover - Mobility Subsystem
Sensors	200.0	140.2	51.7	39.8	39.8	231.6	440.9	Mars Pathfinder - Avionics
Manipulators	200.0	7.1	13.5	10.4	10.4	31.1	440.9	Mars Pathfinder - Mechanisms Subsystem
CC&DH	200.0	108.6	61.3	47.1	47.1	217	440.9	Mars Pathfinder - CC&DH Group
Spare Parts	200.0	39.4	15.6	12.0	12.0	67	440.9	Electrical Power and Distribution Group
Ancillary Equipment	1796.0	103.9	41.3	31.7	31.7	176.9	3959.4	Structural/Mechanical Group
<b>SYSTEM INTEGRATION</b>	<b>13980.7</b>	<b>2110.5</b>		<b>349.7</b>	<b>349.7</b>	<b>2809.9</b>	<b>30822.3</b>	Mars Pathfinder

An integrated life cycle cost wrapper was added to reflect design, development, production, launch, operations as well as maintenance costs. This wrapper was scalable to enable the examination of tradeoffs and conduct sensitivity analysis. Model fidelity is related to the quality of the analogy as well as with how carefully the life cycle context was modeled.

Analysis of the value of ISRU in the context of the Constellation Program was done by Charania [126] in partnership with Shimizu Corporation of Japan. This work included technical and cost models for mining system mass for the production of LOX/H2 propellant from lunar resources (

<sup>179</sup> <https://ntrs.nasa.gov/archive/nasa/casi.ntrs.nasa.gov/19890004515.pdf>



Table 22 [126]). Development, acquisition, transportation, and operations costs were calculated for each of the various case studies. Ares and Altair-derived reusable landers were assumed as the primary transportation architecture for this study. Modeling the requirements for ISRU commercial feasibility was a fundamental part of the work. However, detailed reporting on the technical details of ISRU systems design was sparse.

**Table 22: Cost Models for ISRU Elements that Could Support Constellation**

Parameter	Deterministic/ Most Likely			Minimum	Maximum
	Case 1: Lunar Surface	Case 2: LLO	Case 3: GEO	All Cases	All Cases
<b>DDT&amp;E Cost [\$M, FY2006]</b>	<b>\$957 M</b>	<b>\$ 2,157 M</b>	<b>\$ 2,557 M</b>		
Nuclear Power Plant*	\$200 M	\$200 M	\$200 M		
Excavation/Processing/Storage Facility Cost*	\$595 M	\$595 M	\$595 M	<b>-25%</b>	<b>+75%</b>
Mass of Excavation/Processing/Storage Facility*	\$162 M	\$162 M	\$162 M		
Lunar Tanker Vehicle**	-	\$1,200 M	\$1,200 M		
Orbital Tanker Vehicle**	-	-	\$400 M		
<b>Acquisition Cost [\$M, FY2006]</b>	<b>\$319 M</b>	<b>\$ 1,019 M</b>	<b>\$ 1,044 M</b>		
Nuclear Power Plant*	\$67 M	\$67 M	\$67 M		
Excavation/Processing/Storage Facility Cost*	\$198 M	\$198 M	\$198 M	<b>-25%</b>	<b>+75%</b>
Mass of Excavation/Processing/Storage Facility*	\$54 M	\$54 M	\$54 M		
Lunar Tanker Vehicle**	-	\$700 M	\$700 M		
Orbital Tanker Vehicle**	-	-	\$25 M		
<b>Transportation Cost to Lunar Surface [\$M, FY2006]</b>	<b>\$1,445 M</b>	<b>\$2,220 M</b>	<b>\$2,240 M</b>		
Cargo Launch Vehicle (CaLV)***	\$560 M	\$1,120 M	\$1,120 M		
Earth Departure Stage (EDS)****	\$215 M	\$430 M	\$430 M	<b>-10%</b>	<b>+25%</b>
Lunar Surface Access Module (LSAM)****	\$670 M	\$670 M	\$670 M		
Falcon V or similar launch of OTV	-	-	\$20 M		
<b>Mission Operations Cost [\$M/year, FY2006]</b>	<b>\$35 M</b>	<b>\$35 M</b>	<b>\$35 M</b>	<b>-10%</b>	<b>+50%</b>

Notes:

United States Dollars FY2006 unless otherwise noted

\* - Source: Shimizu Corporation (75% development cost, 25% acquisition cost)

\*\* - Source: SEI internal cost estimates derived from previous work; development cost to the commercial company is for modification of existing stages, not for complete development of a new vehicle

\*\*\* - Source: Charania, A., "The Trillion Dollar Question: Anatomy of the Vision for Space Exploration Cost," AIAA-2005-6637, Space 2005, Long Beach, California, August 30 - September 1, 2005<sup>7</sup>.

\*\*\*\* - Source: Exploration Systems Architecture Study (ESAS) Draft Report, Section 12<sup>6</sup>.

What is needed next is a bottoms-up engineering estimate. Work by Blair [120] and Charania [126] demonstrates that a basis exists for commercial ISRU under specific subsets of feasibility conditions, including reduced development, production and operations costs. Recent work at CSM [115]<sup>180</sup> [42]<sup>181</sup> has re-examined the engineering models and estimated the requirements for cost competitiveness. In some ways is the inverse of the FY02 work done at CSM in that it combines a high-fidelity mining system model with lower-fidelity cost and business/economic approximations. The combination of the two approaches will be a critical next step in determining aggregate feasibility at the systems level.

<sup>180</sup>[http://www.isruinfo.com/docs/srr19\\_ptmss/2-2%20Business%20Case%20for%20Mining%20Propellant%20on%20the%20Moon-Sowers.zip](http://www.isruinfo.com/docs/srr19_ptmss/2-2%20Business%20Case%20for%20Mining%20Propellant%20on%20the%20Moon-Sowers.zip)

[http://www.isruinfo.com/index.php?page=srr\\_19\\_ptmss](http://www.isruinfo.com/index.php?page=srr_19_ptmss)

<sup>181</sup>[http://www.isruinfo.com/docs/srr19\\_ptmss/7-13%20Ice%20Mining%20in%20Lunar%20Permanently%20Shadowed%20Regions-Dreyer.zip](http://www.isruinfo.com/docs/srr19_ptmss/7-13%20Ice%20Mining%20in%20Lunar%20Permanently%20Shadowed%20Regions-Dreyer.zip)  
[http://www.isruinfo.com/index.php?page=srr\\_19\\_ptmss](http://www.isruinfo.com/index.php?page=srr_19_ptmss)

## Heritage Costing

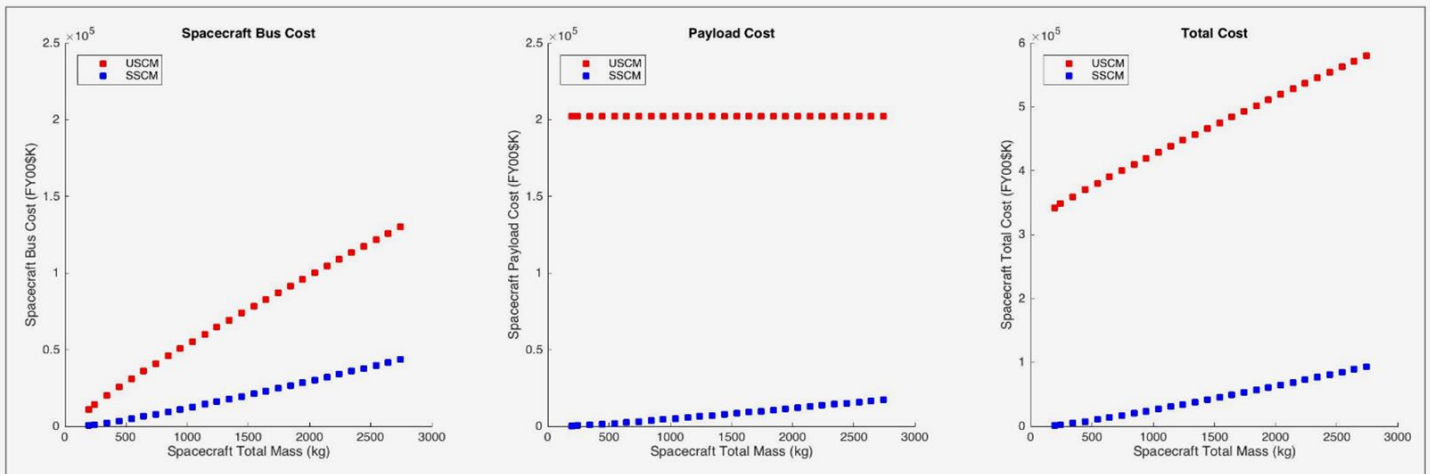
The heritage argument (which is the basis for NAFCOM analogies) boils down to the projection that 'it will cost that much because it has always cost that much'. In the field of economics, the Ceteris Paribus - 'holding everything else constant' - is a common and helpful assumption. That is, until something disruptive happens that disrupts the equilibrium. In this case, the disturbance was noticed when SpaceX delivered the Falcon 9 for a cost substantially lower than anticipated.

*"It is difficult to determine exactly why the actual cost was so dramatically lower than the NAFCOM predictions. It could be any number of factors associated with the non-traditional public-private partnership under which the Falcon 9 was developed (e.g., fewer NASA processes, reduced oversight, and less overhead), or other factors not directly tied to the development approach. NASA is continuing to refine this analysis to better understand the differences." [131]<sup>182</sup>*

The difference in cost was substantial, with some estimating a factor of eight improvements in costs - representing nearly an order of magnitude difference. This disruptive trend appears to be expanding, as witnessed in comparative costing of small satellites as shown in Figure 76 [132]<sup>183</sup>, indicating the need for a new approach. The heritage methods of costing are proving inadequate in predicting the disruptive events that are occurring in the aerospace industry.

### Unmanned Space Vehicle Cost Model (USCM, Version 7) and Small Satellite Cost Model (SSCM, 1998) results for TAT-C generated spacecraft

- Spacecraft are identical, with IR Sensor payloads, except for total mass
- Payload cost differs substantially between the two models
  - Motivation for alternate payload costing approach



**Figure 76: USCM vs. SSCM Cost Model Comparison**

When comparing the publicized costs expressed by NewSpace disruptors to heritage space cost models, one may ask why there is such a disparity. One consideration is that many of the disruptors are selling to commercial space users while heritage space technology costing was primarily focused on government operations. It is clear that the combination of unique requirements and ultra-high reliability needed for cutting-edge government missions creates an extraordinarily challenging trade space for finding cost

<sup>182</sup> [https://www.nasa.gov/sites/default/files/files/Section403\(b\)CommercialMarketAssessmentReportFinal.pdf](https://www.nasa.gov/sites/default/files/files/Section403(b)CommercialMarketAssessmentReportFinal.pdf)

<sup>183</sup> [https://esto.nasa.gov/forum/estf2016/PRESENTATIONS/Foreman\\_Lemiogne\\_B1P4\\_ESTF2016.pdf](https://esto.nasa.gov/forum/estf2016/PRESENTATIONS/Foreman_Lemiogne_B1P4_ESTF2016.pdf)

effective solutions. This is not likely to change any time soon. The market for high-end defense and science missions will always be secure due to the degree of difficulty of actually delivering robust functional results. Traditionally, space hardware was also expensive when chasing marginal returns to reliability (an asymptotic function) requiring an effectively infinite budget. DoD is in constant battle with the ratchet effect known as the ‘space spiral’ seen in Figure 77 [133]<sup>184</sup>.



**Figure 77: The Space Spiral of Increasing Cost**

This trend could be framed as a natural consequence of the heritage cost-plus contracting structure. By locking profit in as a fixed ratio or percentage, maximizing profit requires maximizing contract value and therefore costs. In some ways, this contracting structure valued the reliability, performance, and capability of a system above its ability to innovate for cost savings. Fortunately, many areas of the cost function are beginning to change and represent the NewSpace approach for driving down costs for commercial users. Until very recently, capital equipment for use in space was manufactured for a single use – keeping costs high. Today, organizations across-the-board are designing reuse and refurbishment into launch vehicles and spacecraft.

As costs drop over time markets will naturally expand, increasing *total profit* at lower margins by making up the difference in expanded sales volume. Heritage aerospace companies are sitting in the strongest position to innovate and solidify emerging cost advantages. Reducing capital and operating expenses also enables government to do its job more effectively, allowing individual missions to go further and creating win-win scenarios that are good for the customer. In order to create a sustainable commercial lunar mining operation, innovative cost savings approaches are imperative for facilitating ISRU system deployment and attracting private investment.

### **Cost as an Independent Variable**

Cost as an Independent Variable (CAIV) can be thought of as a kind of inverse to the heritage approach: It has to cost that amount (or less) because that is all we have available. Some in defense acquisition have even tried to use it as a brute force approach to shaving costs from contractors, often with mixed results.

*"All participants in the acquisition system shall recognize the reality of fiscal constraints. They shall view cost as an independent variable, and the DoD Components shall plan programs based on realistic projections of the dollars and manpower likely to be available in future years."* [134]<sup>185</sup>

To close the business case for lunar propellant, cost requirements can be framed as a CAIV problem. Design to Cost (DTC) is the engineering equivalent to CAIV (described in Figure 78 [135]<sup>186</sup>), forming a set of design and evaluation tools to find feasible solutions. The goal would be to work backward to

<sup>184</sup> <https://pdfs.semanticscholar.org/60bb/744c8df6748b32422c8951dbed788d30796b.pdf>

<sup>185</sup> <https://risacher.org/blog/2013/03/cost-as-an-independent-variable/>

<sup>186</sup> <https://ndiastorage.blob.core.usgovcloudapi.net/ndia/2006/systems/Wednesday/casey3.pdf>

constrain the cost targets for lunar surface propellant production while holding the mining architecture under a mass limit while achieving the annual water production level (similar to that described in the Mine Sizing section). Life cycle costs will have to fall below a specific cost/kg for machinery and plant design, development, fabrication, testing, launch, emplacement and operations.

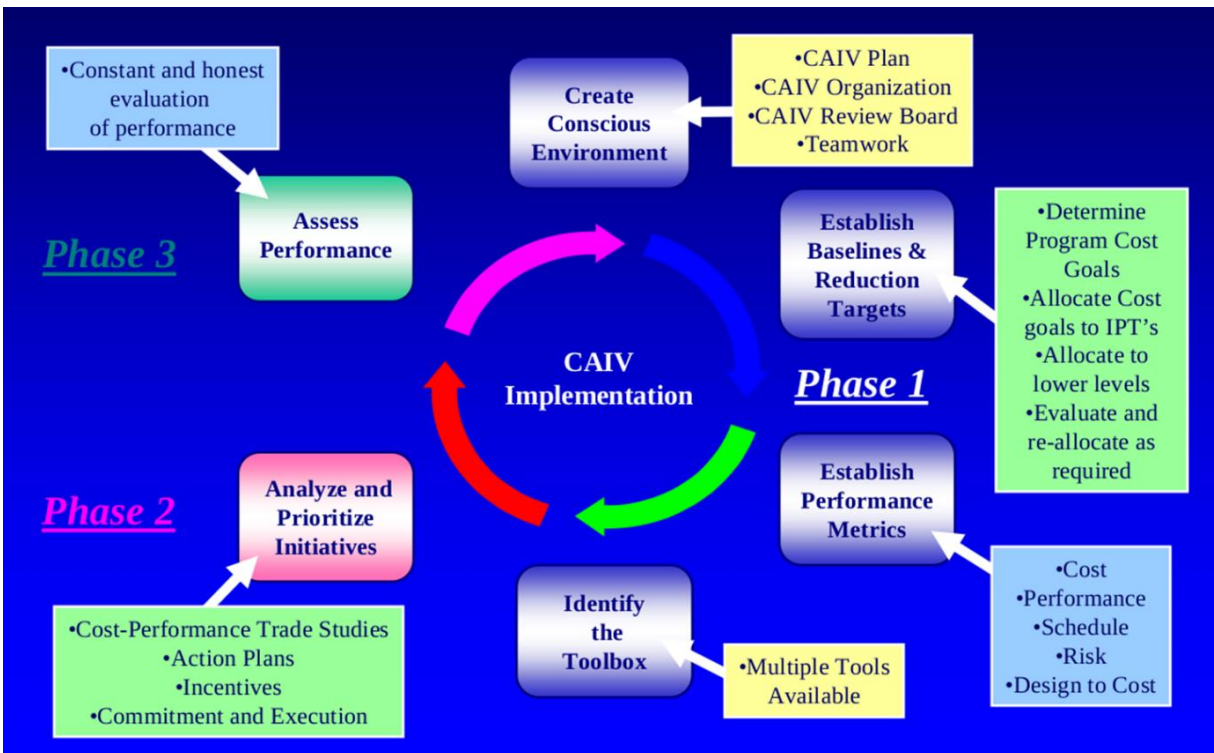


Figure 78: CAIV Implementation and Flow<sup>187</sup>

While CAIV is a good tool for bounding costs, its success strongly depends upon the cost constraints used. This relies upon tightly restraining regions within the trade space of a systems performance, cost, schedule, risk and return on investment [136]<sup>188</sup>. Achieving the required cost targets to enable business model closure will also depend on variability of support infrastructure like power, communication and routine resupply of replacement parts. In a number of important ways, the CAIV and DTC approaches offer important methods for coping with rising competitive pressure by capping development or production costs. However, there is still a need for individual tools that can be used to reduce costs using these generalized methods.

### Cost Reduction<sup>189</sup>

A new cost paradigm is required in order to make space resources more accessible. One useful exercise is to cost space refueling stations and mining equipment using non-traditional-aerospace industry standards (i.e., terrestrial mining industry), project management and finance methods. It is helpful to consider the fact that large-scale oil & gas as well as mining projects need tens of billions of upfront capital investment, with payback periods in the 10-year or more timeframe representing similarities to a commercial lunar mining operation.

<sup>187</sup> Image Credit: Raytheon

<sup>188</sup> [www.dtic.mil/dtic/tr/fulltext/u2/a487933.pdf](http://www.dtic.mil/dtic/tr/fulltext/u2/a487933.pdf)

<sup>189</sup> Section Author: Brad Blair, NewSpace Analytics, Managing Partner

Benchmarking is a useful exercise as well – applying lessons learned across various industries. Options are revealed by looking into the basic variables and hidden assumptions in how other industry costing is done. Indeed, a spectrum of costs are revealed by comparing a set of industry unit hardware costs starting with basic industrial infrastructure, then going through shipping, aircraft and finally basic and advance aerospace projects. The mining literature reveals costs in the current range of ~\$20/kg. Commercial shipyards can produce hardware for a similar cost, with nuclear powered military ships costing ~\$50/kg. Fighter aircraft range from \$5,000 to \$20,000/kg. Commercial satellite hardware manufacturing costs start at \$30,000/kg for a heritage bus and go up as requirements become more custom (e.g., new technology is needed) (Table 23).

**Table 23: Comparative Costs of Manufactured Systems**

Comparative Costs per Kilogram for Manufactured Systems				
	dry mass (t)	cost \$M	\$k/kg	source
<b>Spacecraft</b>				
MSL Rover (Curiosity)	3.8	2500	<b>658</b>	<a href="https://en.wikipedia.org/wiki/Mars_Science_Laboratory">https://en.wikipedia.org/wiki/Mars_Science_Laboratory</a>
GOES-16 weather satellite	5.2	2750	<b>529</b>	<a href="https://spacepolicyonline.com/news/noaas-newest-weather-satellite-goes-s-ready-for-launch/">https://spacepolicyonline.com/news/noaas-newest-weather-satellite-goes-s-ready-for-launch/</a>
Telstar 19V	3.0	100	<b>33.0</b>	<a href="https://spacenews.com/maxar-considering-quitting-geo-satellite-manufacturing-business/">https://spacenews.com/maxar-considering-quitting-geo-satellite-manufacturing-business/</a>
<b>Aircraft</b>				
F-22 Raptor	19.7	339	<b>17.2</b>	<a href="https://en.wikipedia.org/wiki/Lockheed_Martin_F-22_Raptor">https://en.wikipedia.org/wiki/Lockheed_Martin_F-22_Raptor</a>
B-2 Stealth Bomber	71.7	1152	<b>16.1</b>	<a href="https://en.wikipedia.org/wiki/Northrop_Grumman_B-2_Spirit">https://en.wikipedia.org/wiki/Northrop_Grumman_B-2_Spirit</a>
F-18E	13.4	120	<b>8.9</b>	<a href="https://www.defense-aerospace.com/dae/articles/communiques/FighterCostFinalJuly06.pdf">https://www.defense-aerospace.com/dae/articles/communiques/FighterCostFinalJuly06.pdf</a>
F-35A	13.2	94.6	<b>7.2</b>	<a href="https://en.wikipedia.org/wiki/Lockheed_Martin_F-35_Lightning_II">https://en.wikipedia.org/wiki/Lockheed_Martin_F-35_Lightning_II</a>
F-15E	20.4	136	<b>6.7</b>	<a href="https://www.defense-aerospace.com/dae/articles/communiques/FighterCostFinalJuly06.pdf">https://www.defense-aerospace.com/dae/articles/communiques/FighterCostFinalJuly06.pdf</a>
<b>Navy Ship (nuclear powered)</b>				
Virginia Class Submarine	7900	3200	<b>0.41</b>	<a href="https://en.wikipedia.org/wiki/Virginia-class_submarine">https://en.wikipedia.org/wiki/Virginia-class_submarine</a>
Ford-class Aircraft Carrier	100000	13000	<b>0.13</b>	<a href="https://en.wikipedia.org/wiki/Gerald_R._Ford-class_aircraft_carrier">https://en.wikipedia.org/wiki/Gerald_R._Ford-class_aircraft_carrier</a>
<b>Mining Equipment</b>				
Rear Dump Truck (55t)	41.2	0.938	<b>0.023</b>	<a href="http://costs.infomine.com/costdatacenter/miningequipmentcosts.aspx">http://costs.infomine.com/costdatacenter/miningequipmentcosts.aspx</a>
Wheel Loader (7 cu m)	50	0.912	<b>0.018</b>	<a href="http://costs.infomine.com/costdatacenter/miningequipmentcosts.aspx">http://costs.infomine.com/costdatacenter/miningequipmentcosts.aspx</a>
Hydraulic Shovel (4 cu m)	60	1.025	<b>0.017</b>	<a href="http://costs.infomine.com/costdatacenter/miningequipmentcosts.aspx">http://costs.infomine.com/costdatacenter/miningequipmentcosts.aspx</a>
<b>Drill Ship</b>				
GustoMSC PRD12,000 Drillship	45000	710	<b>0.016</b>	<a href="https://www.offshore-mag.com/articles/print/volume-72/issue-7/rig-report/reviewing-rig-construction-cost-factors.html">https://www.offshore-mag.com/articles/print/volume-72/issue-7/rig-report/reviewing-rig-construction-cost-factors.html</a>

Stepping through Table 23 backwards, there is hope that incremental steps toward cost reduction may be possible. However, one must consider the conditions that enable different costing regimes. In order to transition the commercial lunar propellant hardware to a lower cost regime than current spacecraft, four areas can be focused on:

1. Design for maintainability
2. Automate processes
3. Find agile and innovative solutions
4. Design for reuse

To explore the first focus area, consider that today, replacement parts are typically not created for spacecraft. This is because they are thought to be unserviceable once launched. A system like the lunar propellant mine would be designed for maintainability and have a continuous stream of replacement parts being produced. This alone would put the hardware costs of a lunar propellant plant in a different cost regime than traditional spacecraft. Preventative maintenance will also maximize operational availability of the lunar mine given the natural limitations imposed by entropy and the extreme operating environment. Mean time between failures combined with systems redundancy need to be well defined, and are key decision variables in anticipating operational robustness. Collection of failure statistics using embedded

sensors also enables prevention and reduces risk of system failure. The idea is simple – maximize the service lifetime of the capital investment.

In regards to the second focus area, consider that operating costs for NASA programs are typically estimated at roughly 10% of production cost per year. This costing approach is an artifact of the days when everything was done by people. Software and automation innovation will certainly play a role in reducing these types of costs. Modern software development methods offer a wellspring of innovation to tap into, especially when combined with sensors, databases and predictive statistical methods. Recent advances in software enable radical leaps in design productivity. The current revolution in AI will provide accelerated access to these tools.

*Currently, in the area of satellite control, there is a general interest in automating as a way of reducing in-orbit satellite maintenance costs, specially the high cost with teams operations. Besides the cost reduction, the automation can minimize errors that may be introduced by repetitive tasks." ... operations include "telemetry monitoring, sending remote command and the implementation of tracking measurements, such as range and range rate, and execution of procedures" [137]<sup>190</sup>*

*"Boeing is in the process of changing the way satellites are built and made operational, according to the Wall Street Journal, with an eye toward automating much of the process and making it easier to ramp production while also increasing overall efficiency. Boeing's efforts reflect the general transformation of the private space industry, driven by pressure put on incumbents by new entrants with a more nimble approach to getting the job done..." [138]<sup>191</sup>*

The practices of focus area three can most readily be adopted from the strategies employed by successful Silicon Valley companies. Silicon Valley offers a rich array of management tools and operational experience that can also help reduce costs for developing and emplacing a commercial lunar propellant plant. Their innovative and agile approach to marrying otherwise unassociated technologies or methods may help break down many of the cost barriers that exist today. The recent rise and maturity of automation combined with the use of commercial-off-the-shelf components are viewed as major keys to unlocking value.

*"Software and hardware—and their associated development practices—have matured over the past three decades and the lessons learned from this maturation have been taken on board by emerging space organizations, to prove that "agile" methodology can be used for ambitious space challenges. An agile approach can lead to a reduction of cost, reduction of time, reduction of risk, and allow the evolution of more optimal approaches." [139]<sup>192</sup>*

*"The many technologies needed for space settlement will grow organically as new companies emerge. Modern collaborative software is making it easier to start ambitious new organizations with minimal overhead. Minimal processes and structure are added only where needed and in ways to increase overall efficiency. It is not the intent to have any one-team design all the systems or manage them—new organizations will play a critical role in space settlement. Settling space is a large project and the agile framework provides the opportunity for scaling to large self-organizing teams." [139]*

---

<sup>190</sup> <http://mtc-m21b.sid.inpe.br/col/sid.inpe.br/mtc-m21b/2014/11.18.23.59.25/doc/62E2014-1846.pdf>

<sup>191</sup> <https://techcrunch.com/2017/02/21/boeing-wants-to-turn-satellites-into-a-cheaper-highly-automated-business/>

<sup>192</sup> <https://doi.org/10.1089/space.2015.0038>, <https://www.liebertpub.com/doi/abs/10.1089/space.2015.0038>

Finally, considering the fourth focus area, reuse is, in fact, as old as the space age (recall that Kraft Erickhe designed the original Centaur upper stage to be reusable). The single largest contributor to the high cost of space hardware has been the expendable paradigm. It acts as a cost multiplier, and includes more than just hardware. The lack of refueling infrastructure exacerbates the problem. Fortunately, organizations like DARPA are working on a set of progressive enabling technologies that activate the ‘sufficient criteria’ for in-space reuse. This includes both servicing and refueling capabilities that will enable maintainable and reusable spacecraft. Their deployment and commercial use is nearly mature.

*"...Public-private partnership to develop on-orbit robotic servicer that would radically lower the risk and cost of space operations" [140]<sup>193</sup>*

*"On-orbit servicing is an emerging capability that can potentially revolutionize how satellites operate in space. The ability to fix anomalies or extend service life for aging satellites can change the way the industry views risk and develops mission plans. Direct beneficiaries of this enabling technology are the commercial companies providing the servicing, the insurance companies who can develop new markets and limit payouts, and the client satellites whose effective mission lifetime is extended. The government could also reap indirect benefits through greater industry stability and service predictability." [141]<sup>194</sup>*

A dramatic change is now at hand. Something has disturbed the equilibrium. The cost reduction methods recommended above are already beginning to take root in the aerospace industry; and with them, we are seeing a paradigm shift within the industry.

*"The space industry is witnessing a major disruption, guided by innovation and determination to take bold risks." [142]<sup>195</sup>*

Once the commercial lunar propellant plant is established, its products will demonstrate a unique ability to linearize the rocket equation. The combination of space resources, a distributed set of propellant supply nodes in space, and reusable orbital transfer vehicles and landers will open the inner solar system for industrial development. Yet it is very clear that costs must drop for this to take hold. Not only launch costs, but also the design, development and manufacturing cost of space hardware need to fall. Powered by the competitive imagination and new sources of private capital, emerging space markets are the bait that can entice this new cost paradigm into position. Government partnerships will play a critical role in popping out of today’s local optima and finding a new global optimum – one that enables orbital economies of scale and reveals the foundation for building massive new wealth.

### **Standards as Cost Savings**

The use of standards has measurably dropped costs across entire industries. They provide benefits such as defining accurate and necessary measurements, and can lower production costs while improving performance, quality, uniformity, interoperability and functionality.

*"Standards are like DNA; they are the basic building blocks for all technology and economic systems." [143]<sup>196</sup>*

Standards can enhance the safety of industrial operations, assure quality to a potential customer, reduce waste, and minimize confusion. They facilitate product acceptance and can bring products to market

---

<sup>193</sup> <https://www.darpa.mil/news-events/2017-02-09>

<sup>194</sup> <https://aerospace.org/sites/default/files/2018-05/OnOrbitServicing.pdf>

<sup>195</sup> <https://doi.org/10.1089/space.2017.0032>

<sup>196</sup> <http://www.strategicstandards.com/files/Articles/StrategicStandardSettingOnTheGlobalStage2004.pdf>

quicker. In addition, they avoid having to “reinvent the wheel every time a product is manufactured” [144]<sup>197</sup>. A good example of this would be the specification of fuel ports standards for Blue Origin and other lunar landers. Another would be common interfaces/docking ports for habitation components and nodes. Standards for communications and power will also reduce costs and could utilize or adopt terrestrial counterparts.

*"Think of it like a spider's web. A typical image of a web will show a series of nodes, with spokes branching out from each node in a radial manner connecting the nodes together. Each node could represent a company, or an application, or a dataset that needs to be connected to a counter-party. Every spoke represents a custom interface that has to be developed and maintained. Having an industry-developed standard literally blows the cobwebs away by replacing those proprietary interfaces." [145]*

A relevant example of corporate leadership in setting a space standard is illustrated by the Satellite Procedure Execution Language and Library (SPELL) project... SES released SPELL in 2007 as a free, open-source software framework used to automate the execution of satellite procedures, and its use has been adopted as a standard in satellite control software [146]<sup>198</sup>.

*"Thanks to the generic and system-independent approach of SPELL, it provides homogeneity across different platforms and satellite control systems. It reduces risks in satellite operations by increasing automation, improves readability of procedures and their operational efficiency, therefore bringing cost-efficiency, as already proven by SES, where SPELL is used to control 35 satellites in our fleet in February 2015." [146]*

Government can play a strong role in standardization and is a prime beneficiary of the cost reductions that result. Indeed they are:

*"... exploring new paradigms of hardware development that challenge traditional practices. Specifically, the Office of the Director of National Intelligence (ODNI) and the DARPA are working to standardize component interfaces and develop new architectures of satellite hardware interoperability that advance capabilities, reduce costs and generate new business opportunities." [147]<sup>199</sup>*

The mining and energy industries aggressively utilize standards to manage products, operations and control costs.

*"Clearly, there is a cost to developing a standard, but there is an even greater cost for an industry in NOT having a standard, since it means developing and maintaining a multitude of different interfaces between systems. For example, one upstream Oil and Gas Company estimated that they have some 4,000 or more different interfaces between their applications. Imagine the total cost for the industry when you multiply this by the number of oil and gas companies, each of whom must develop and maintain multiple interfaces." [145]*

---

<sup>197</sup> <https://www.api.org/~media/Files/Publications/FAQ/valueofstandards.pdf>

<sup>198</sup> <https://www.ses.com/blog/spell-story-vision-innovation-and-execution>

<sup>199</sup> <https://www.aia-aerospace.org/wp-content/uploads/2016/05/AIACostReductionReport.pdf>





## **Legal**

## **Rights and Regulation<sup>200</sup>**

There are many challenges that lie ahead for these emerging space-mining companies. Most are technological, but others require legal solutions. Some of the legal issues that are at the forefront include:

1. The right to own any extracted resources
2. Priority rights to mining claims
3. Noninterference in mining operations
4. Regulatory clarity without excessive regulation

### **Ownership Rights**

The highest legal hurdle to clear in the terms of ownership rights for private companies over space resources is found in Article II of the Outer Space Treaty [71]<sup>201</sup>. It states, “[o]uter space, including the Moon and other celestial bodies, is not subject to national appropriation by claim of sovereignty, by means of use or occupation, or by any other means.” Fortunately, most experts interpret this Article as prohibiting national appropriation of entire celestial bodies but allowing for the ownership of extracted resources. In other words, the law regarding the extraction of space resources is largely seen as analogous to the law of the high seas, which allows international waters to be fished and seabed to be mined.

Despite the weight of expert opinion falling on the side of ownership rights, there are still some who question the legality of private ownership rights over space resources. To provide clarity on this point, the *US Space Resources Exploration and Utilization Act of 2015* [148]<sup>202</sup> was enacted to give comfort to investors that ownership rights may be asserted over any “abiotic resource in situ . . . found on or within a single asteroid” that has been “recovered” by a US citizen.

Although domestic legislatures are working to eliminate uncertainty on this issue, questions remain. For example, would a right to extract natural resources allow a company to mine a small asteroid until it is completely consumed? Another question raised by a minority of commentators is whether the Outer Space Treaty prohibition on national appropriation has any application to private mining activity at all. The clear majority understands that all private activity is attributed to the state and the state can therefore be found liable for the activity of private companies organized in the state.

### **Priority Rights to Mining Claims**

Priority rights might most easily be accomplished with a public registry and a “first to register” priority rule. However, multiple side issues would remain. How large could the claim be? How long should the exclusive mining rights last? Perhaps the priority rights should be awarded only after an organization has some physical presence on the mining site, but not merely based on having discovered resources by remote sensing. This would also protect against claims being granted to companies that have no actual intention or capability to mine.

### **Noninterference**

Companies also need assurance that their operations will be protected from interference from competing companies. In its simplest form, a “zone of noninterference” could be implemented through the same registry used to determine priority. Once a company registers the coordinates and nature of its activity, all other entities would be put on notice of (1) any potential interference with the activity of a foreign party

---

<sup>200</sup> Section Author: Mark Sundahl, Cleveland State University, Cleveland-Marshall School of Law Professor

<sup>201</sup> <http://www.unoosa.org/pdf/publications/STSPACE11E.pdf>

<sup>202</sup> <https://www.gpo.gov/fdsys/pkg/CRPT-114hrpt153/pdf/CRPT-114hrpt153.pdf>

and (2) trigger a duty under Article IX of the Outer Space Treaty for consultations prior to the commencement of any activities that could result in “harmful interference.”

### **Regulatory Clarity without Excessive Regulation**

As the space mining industry evolves, the law will evolve with it. Regulatory clarity is necessary in order for investors to evaluate regulatory risk. The need to create new regulations for the US space industry springs from Article VI of the Outer Space Treaty which requires states to “authorize and continually supervise” the activities of their nationals. Compliance with Article VI is generally seen as requiring that states establish a process for companies to receive authorization for their space missions. The United States is behind the curve on this issue because currently no government agency is clearly authorized by Congress to license nontraditional space activities, such as asteroid mining (although a bill is working its way through the aisle).

### **The Hague Space Resources Governance Working Group**

While individual countries, such as the United States and Luxembourg, are taking steps under domestic law to provide the legal clarity needed by the mining companies, clarity is also needed on the international level. *The Hague Space Resources Governance Working Group*<sup>203</sup> is the leading international effort to address the legal issues related to space mining.

### **Appropriations<sup>204</sup>**

When considering lunar activities, one issue where certainty would help with investment is the question of private property rights in outer space. Clear and recognized freely transferrable property rights lie at the heart of Western prosperity.<sup>205</sup> “Absent legally recognized rights to buy, own, and sell titled property, it is difficult, if not impossible, to get a loan to purchase said property, improve it, mine it, drill for minerals on it, or sell the proceeds from any of those activities. Property rights are a sine qua non of wealth creation  
....”<sup>206</sup>

For US companies, Congress resolved one-half of the uncertainty by recognizing private claims to extracted resources when it passed the Space Resource Exploration and Utilization Act of 2015 [148]. The question of what property interests a private entity may exercise or what right it may have against someone with a competing claim to terrain it is working carries less certainty. Many scholars and government officials interpret the outer space treaties as barriers to private property under different theories. A careful reading of the treaties, however, shows that contrary theories may better reflect what the treaties actually say. Additionally, what the treaties have to say about the permissibility of private property rights remains a question of first impression. Meaning that all the scholarly articles, the different position statements from federal agencies, the wishes of space pioneers, have not been put through the crucible of litigation, and no judge has rendered a decision as to the accuracy of those interpretations. Accordingly, because a question

---

<sup>203</sup>[http://www.unoosa.org/res/oosadoc/data/documents/2018/aac\\_105c\\_22018crp/aac\\_105c\\_22018crp\\_18\\_0\\_html/A\\_C105\\_C2\\_2018\\_CRP18E.pdf](http://www.unoosa.org/res/oosadoc/data/documents/2018/aac_105c_22018crp/aac_105c_22018crp_18_0_html/A_C105_C2_2018_CRP18E.pdf)

<sup>204</sup> Section Author: Laura Montgomery, Catholic University’s Columbus School of Law, Professor of Space Law

<sup>205</sup> Rand Simberg, *Homesteading the Final Frontier, A Practical Proposal for Securing Property Rights in Space*, Competitive Enterprise Inst., <http://cei.org/sites/default/files/Rand%20Simberg%20-%20Homesteading%20the%20Final%20Frontier.pdf> (Apr. 2012)(Last Checked Sept. 6, 2017) *citing* Hernando de Soto, *The Mystery of Capital: Why Capitalism Triumphs in the West and Fails Everywhere Else* (New York: Basic Books, 2003).

<sup>206</sup> *Id.*

of first impression is one where no binding legal authority controls the answer,<sup>207</sup> it might help to take a fresh look at the permissibility of private property rights.

There are several theories under which private entities may not claim property in space: a theory of the commons, the Outer Space Treaty's bar to national appropriation, and a desire to forbid to private entities whatever is explicitly forbidden to states through theories of conformity or responsibility. There are an equal number of responses.

### **Space as a Commons**

Many argue that space is a commons because it is “the province of all mankind” under the Outer Space Treaty or the “heritage of mankind” under the Moon Treaty. As the work of Professor Henry Hertzeld of George Washington University and Christopher Johnson and Brian Weeden of the Secure World Foundation shows, this is not correct. What really constitutes the “province of all mankind” is not outer space but the activity of exploring and using it.

Article I of the Outer Space Treaty says:

*The exploration and use of outer space, including the Moon and other celestial bodies, shall be carried out for the benefit and in the interests of all countries, irrespective of their degree of economic and scientific development, and shall be the province of all mankind. Outer Space, including the Moon and other celestial bodies, shall be free for exploration and use by all States without discrimination of any kind, on a basis of equality and in accordance with international law, and there shall be free access to all areas of celestial bodies. [71]*

These scholars explain that it is exploration and use of outer space that is the province of all mankind, not outer space itself. Additionally, since the United States has not signed the Moon Treaty, and most spacefaring nations have not, there is no need to explore the meaning of common heritage.

### **Bar on National Appropriation**

Some suggest that the Outer Space Treaty's Article II, which prohibits national appropriation of outer space, including<sup>208</sup> the Moon and other celestial bodies,<sup>209</sup> means that no one may appropriate space. The quick answer to this is that the treaty prohibits national appropriation, not all appropriation or private appropriation.

### **Imputation of Treaty Prohibitions on State Actors to Private Actors**

Some claim that Article VI's provision that States Parties to the treaty assure “that national activities are carried out in conformity with the provisions set forth in the present Treaty” means that commercial actors must abide today, even absent legislation, by each provision in the treaty, even the provisions that only apply to governments. This approach ignores the plain language of the treaty.

Conforming to the treaty should not mean that what is forbidden to States Parties must be forbidden to private entities as well. The treaty does not say that. It only says that private entities must conform. When Article VI calls for private conformity to the provisions of the treaty, it leaves unsaid which provisions apply. A review of the treaty shows that most of it applies to “States Parties.” When the treaty's drafters meant a provision to apply to non-governmental entities they said so, such as in the non-interference

---

<sup>207</sup> “First Impression,” Legal Information Inst., Cornell Law School [https://www.law.cornell.edu/wex/first\\_impression](https://www.law.cornell.edu/wex/first_impression). (Last visited Sept. 3, 2017).

<sup>208</sup> In the interests of brevity, the reader may assume that, unless otherwise indicated, references to “outer space” always include the Moon and other celestial bodies.

<sup>209</sup> Outer Space Treaty, Art. II.

provision of Article IX. Accordingly, when we determine to which provisions a private entity must conform, we see that very few apply to private actors.

Article II's bar on national appropriation may mean a number of different things, some of which are less burdensome for the private sector than a ban on recognizing private property rights. Indeed, to the extent that Article VI calls for conformity by private actors, a less burdensome interpretation would be that private actors may not serve as a conduit for national appropriation. Accordingly, state owned enterprises would not be able to appropriate parts of outer space, but private entities could.

In this same vein, others argue that Article VI's statement that "States Parties to the Treaty shall bear international responsibility for national activities in outer space... whether such activities are carried on by governmental agencies or by non-governmental entities..." means that what is forbidden to states must be forbidden to their citizens. Again, this theory ignores the plain language of the other provisions, which for the most part say they only apply to States Parties. When the treaty drafters meant to address non-governmental entities or a country's nationals, they did so specifically. Moreover, the fact that an entity may be responsible for someone else does not automatically mean that what is forbidden to the first entity is forbidden to the second one. Person A may be responsible for Person B's debts, but when Person A loses his driver's license, Person B may continue to drive.

Although the US State Department once claimed, "private ownership of an asteroid is precluded by Article II,"<sup>210</sup> the US Congress has since exercised its legislative authority to override and disagree at least in part by passing the Space Resource Exploration and Utilization Act. That new law recognized the rights of private entities in resources they may extract from outer space.<sup>211</sup> It is possible that where the State Department was wrong before, others will be wrong about any prohibition on private claims.

#### **Adverse Possession: A Way Forward**

Finally, in order to steer a clear path forward, it might be useful to explore how a private entity could figure out whose property interests prevail in a dispute. Professor of Law, Thomas E. Simmons, in his study *Deploying the Common Law to Quasi-Marxist Property on Mars* [149], suggests that the common law principle of adverse possession would be a useful tool in resolving disputes. He recommends that any solutions to the problem "hew as closely as possible to the non-appropriation and common use [treaty] text, thus minimizing the possibility of outright judicial rejection of a request to recognize and enforce private property rights..." He considers two common law principles consistent with such a reading, namely, the principles of adverse possession and tenancy-in-common.

He also explores the availability of US courts. This requires viewing the courts as mere adjudicators of disputes, which is not a hard observation to make in light of the fact that that is indeed a function they serve. That they are a branch of a government does not mean that the court has appropriated any land; merely that it has settled a dispute as between two entities who both want to use it. This approach may be a fruitful one for further analysis.

Just as existing technology may allow commercial extraction and use of space resources, so may existing law provide a platform for those activities to occur. The treaties do not need to be read to preclude private ownership.

---

<sup>210</sup> Virgiliu Pop, *Who Owns the Moon? Extraterrestrial Aspects of Land and Mineral Resources*, p. 42 quoting Letter from Ralph L. Braibanti, Director, Space and Advanced Technology, US Department of State/Bureau of Oceans and International Environmental and Scientific Affairs (Aug. 15, 2003).

<sup>211</sup> 51 U.S.C. § 51303.



## **Benefits**

## Enabled Industries

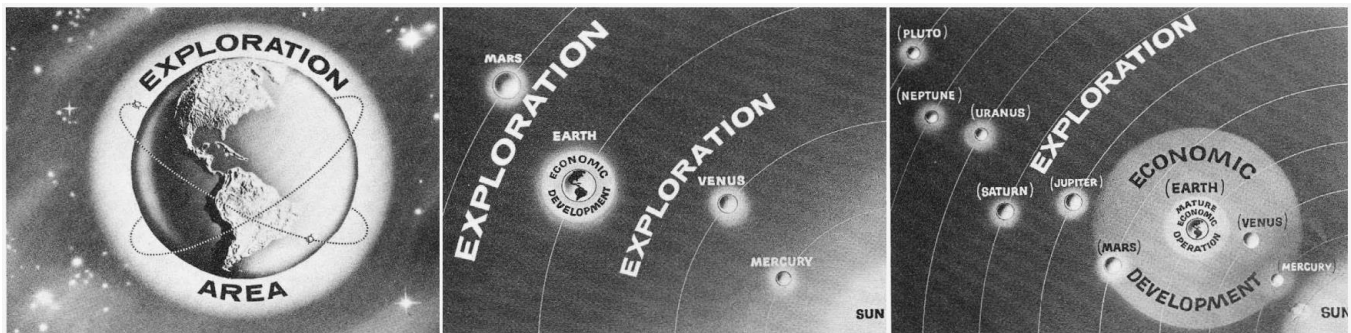
### An Emerging Cislunar Marketplace<sup>212</sup>

An entire eighth continent worth of natural resources sits at the edge of Earth's gravity well, waiting for the right combination of vision, capital and initiative to unlock its wealth. Combined with reusable upper stages and landers, a space-based supply of propellant has long been seen as the key that could enable access to much of the inner solar system. The recent confirmation of lunar polar volatiles provides an access point to a supply line of in-space propellant. Refueling can linearize the rocket equation.

Emerging space markets are being persistently built as customer requirements for new products and services expand into an evolving commercial ecosystem. NASA not only understands the importance of this dynamic on expanding the strength of the US space industrial sector, they have become willing and capable partners in the process. The seeds for successful partnerships were sown into the Space Act that created NASA in 1958. Elements within the civilian space agency have allowed those seeds to take root and are nurturing their growth and maturation.

*"Our goal is to develop the capabilities that will allow the American people to explore and expand our economic sphere into the solar system" [150]<sup>213</sup>*

The economic fundamentals of cislunar space were clearly articulated in 1961 by Ralph J. Cordiner, Chairman of the Board of General Electric [151]<sup>214</sup>. At that time GE was a major government contractor close to the center of the Apollo program. Based on historical precedents, he predicted there would be three basic stages of space frontier development as shown in Figure 79 [151] below: The stage of exploration; the stage of economic development; and, the stage of mature economic operation. The rise of profitable communication satellites in the 70's and 80's marked the arrival of Stage 3 for Earth orbit. We are now entering Stage 2 for cislunar space. Deep space and much of the asteroid belt are still in Stage 1.



**Figure 79: Stages of Exploration and Development in Cislunar Space**

Critical of the top-down management control style advanced by the former Soviet Union, Cordiner tirelessly championed the competitive free-enterprise model. He claimed that national economic and military progress will be “faster and more solid if competitive private enterprise does just as much of the technical work as possible” while government provides the legal and policy framework to stimulate outstanding technical performance. Cordiner suggested that a civilian space agency engaged in scientific exploration would naturally identify greenfield economic opportunities - giving it a unique vantage point

<sup>212</sup> Section Author: Brad Blair, New Space Analytics, Managing Partner

<sup>213</sup> [https://www.nasa.gov/sites/default/files/files/Emerging\\_Space\\_Report.pdf](https://www.nasa.gov/sites/default/files/files/Emerging_Space_Report.pdf)

<sup>214</sup> <https://rjacobsen.files.wordpress.com/2011/02/cordiner-article-1961.pdf>

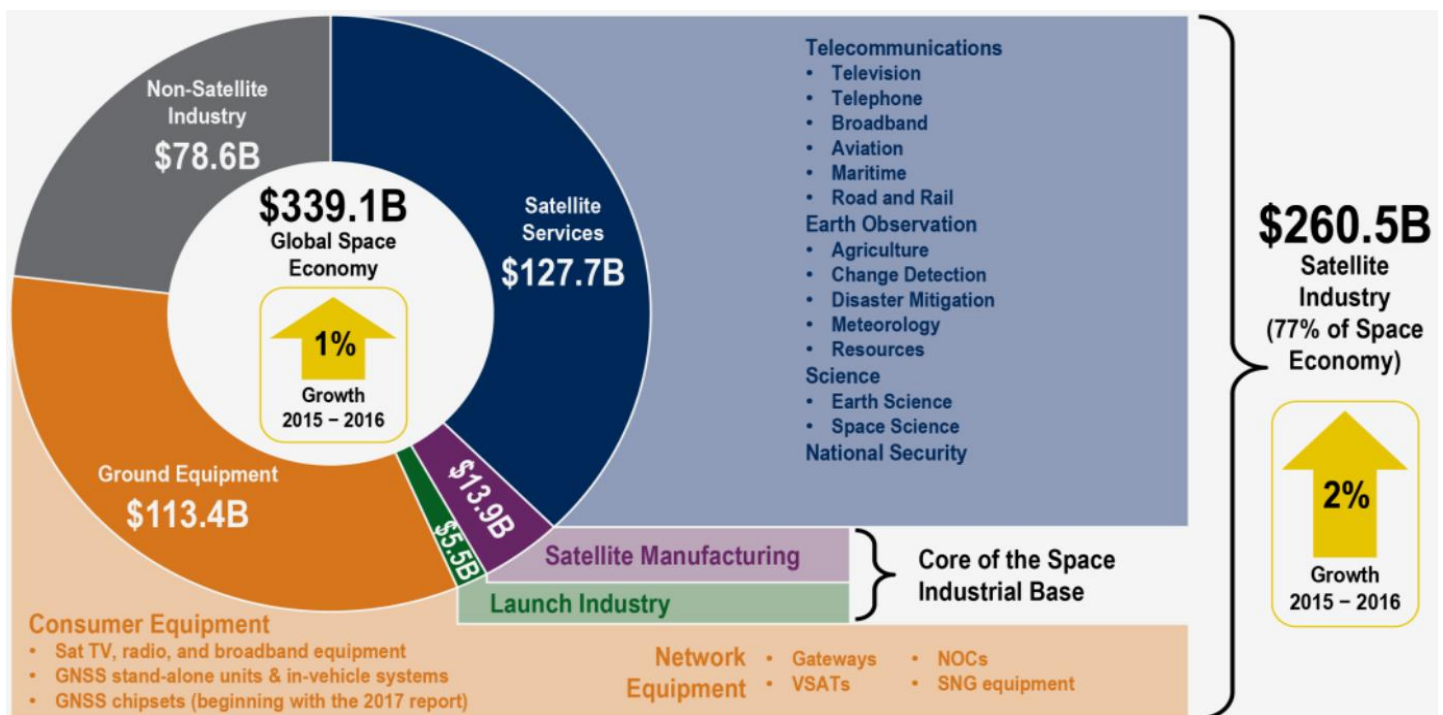
to sense the direction pointing toward future national prosperity. He then cited centuries of history of the very same process, including the expeditions of Columbus and Lewis & Clark, leading to the conclusion:

*“The most important long-term impact of the new space capabilities, therefore, is that they open up a new frontier for exploration and economic development. From the businessman's viewpoint, this spells risk and opportunity. But there will be other effects on the nation's business life.”* [151]

That articulated vision turned out to be quite prescient. The list of ‘business effects’ a.k.a. benefits predicted in the 1961 paper included the development of advanced technologies (foreshadowing the computer age), the development of large-scale planning and integration tools (foreshadowing the software revolution), and the creation of “new businesses of all sizes.”

*“Yet innovative businesses can’t evolve in a vacuum. They must attract resources of all sorts, drawing in capital, partners, suppliers, and customers to create cooperative networks.”* [152]<sup>215</sup>

Space commerce in Earth’s orbit today just passed one third of a trillion dollars with business activities that includes communication, navigation and remote sensing as summarized in Figure 80 [153]<sup>216</sup> below. This sphere of space commercial opportunities is currently under expansion, as innovations in additive manufacturing, satellite servicing, commercial space stations and related fields are being financed by industry and private investors. As the cost of in-space transportation is reduced by lunar propellant, it has been estimated that the gross space product could generate as much as \$2.7 trillion per year within the next 30 years<sup>217</sup>.



**Figure 80: Heritage Space Commerce Market Segments and Size**

<sup>215</sup> <http://blogs.harvard.edu/jim/files/2010/04/Predators-and-Prey.pdf>

<sup>216</sup> <https://go.guidants.com/q/db/a2//1e1ffc185c1d44bd.pdf>

<sup>217</sup> <http://www.moonsociety.org/mmm/302>



### **Utilities in Space<sup>218</sup>**

Aside from the new capabilities and mission profiles that lunar propellant can support, entirely new ecosystems can be supported by sustained, commercial activities on the Moon. As power, communications, transportation, and other services expand in support of lunar activities, the formation of the first extraterrestrial utilities should result. In particular, power requirements will be extremely high for any space based industrial operations or settlements. This makes SBSP a great candidate as a stand-alone space utility supporting a multitude of customers. The unbundling of commercially relevant space power systems (i.e., the separation of power generation, transmission, distribution, and loads) along with the multiplexing of ancillary services (e.g., data, communications, and navigation, time) is part of a traditional market segmentation.

A space power utility may employ Space-to-Space Power Beaming (SSPB) Space-to-Alternate Surface power beaming, and eventually Space-to-Earth power beaming depending on the need of the customer. SSPB technology is currently being developed through ground based piecewise testing and the ISS will soon offer as the premier testbed for a frequency-agnostic-radiant-energy beaming technology demonstration. It is possible to incrementally progress from Technology Development, Demonstration, and Deployment (TD<sup>3</sup>) missions to an electrical power and ancillary services utility (e.g., the Lunar Power & Light Company<sup>219</sup>) [154]. This approach provides for organic growth using agile software driven development and inherently open architectures with plug-in/plug-out hardware, software, and mission operations control applications interfaces [155] [139] [156].

The scalable nature of the commercial lunar propellant plant is the foundation of a cislunar economy that supports a variety of industries. As commercial providers advance their technology through demonstration and implementation, they will inadvertently create the first stand-alone and scalable space utilities. These utilities will then foster competition; further improving the technology, cost, and efficiency of the various subsystems. In turn, these improvements will enable larger operations, grander exploration missions, and make permanent space settlement feasible.

### **Supporting Human Settlement<sup>220</sup>**

The potential for geometric economic rewards entice us toward a new golden age, as humanity becomes a “multi-planet species” [157]. Combining the richness of space mineral and volatile resources with natural environments that offer extreme cold, ultra-high vacuum, microgravity and abundant solar energy offers access to industrial processes that could only be imagined by prior generations. A multi-billion dollar investment today could unlock trillions in new wealth as shown in Figure 81 [153] (important note: *the financial industry is paying attention*). Primary systems that are needed to enable this include reusable upper stages and landers, a local source of minerals and/or rocket fuel, and a vision for what to do with those building blocks. All three are under commercial development today and essential parts of the lunar propellant production architecture - now is the time to act. The resources of the future are waiting to be harvested and brought to market.

---

<sup>218</sup> Section Author: Gary Barnhard, Xtraordinary Innovative Space Partnership, CEO

<sup>219</sup> <http://www.xisp-inc.com/>

<sup>220</sup> Section Author: Brad Blair, New Space Analytics, Managing Partner



Source: BofAML Global Research based on various sources

**Figure 81: Emerging Space Markets as Seen by Analysts at Bank of America Merrill Lynch**

The CisLunar 1000 Vision developed by ULA lays out a plan for expanding human infrastructure into space, estimating the growth of a space population to 1000 people by 2047. NASA, Blue Origin and SpaceX are developing capabilities that could support the transportation needs for future space exploration, tourism and settlement. Bigelow Aerospace and Thin Red Line have published plans for commercial space and planetary surface habitation systems. The commercial development of prospecting, mining and planetary ore processing systems is the next logical step in developing the infrastructure to support the expansion of the human race into the next frontier.

Space settlement could rapidly expand future markets. Humans have proven to be steady and reliable customers with well-understood preferences. They are agile and can operate and fix things. In addition, they consume like crazy. Terrestrial demographic research is constantly trying to figure out what they want and need in order to stay one-step ahead of them and provide products and services they will buy. The high value they can provide combined with the personal risks they must take to survive in a new and radically different environment should justify large paychecks. This will provide a revenue source to purchase advanced locally made products, build or buy local housing and start local businesses. People will also stimulate innovation due to their creative nature. In addition to the visions of Musk (hundreds of thousands living on Mars) and Bezos (millions living and working in cislunar space), space population forecasts include ULA's CisLunar 1000 vision and a quantitative model published in the IAA Cosmic Study on Space Mineral Resources [158]<sup>221</sup>. This even estimated the propellant and consumable air and water needed to

<sup>221</sup> <https://www.amazon.com/Space-Mineral-Resources-Assessment-Opportunities-ebook/dp/B018OJD95Q>

support future cislunar human populations. See Table 24 [158] below. Note the interpolation of ULA’s forecast of 1000 people in 2047 roughly fits this estimate.

**Table 24: Space Population Forecast and Propellant Consumption Model**

in-space population distribution	2010	2025	2040	2055	2070
LEO outpost	6	37	218	1131	7891
EML1 outpost	0	10	79	323	2630
Moon Surf outpost	0	2	68	647	5261
Phobos outpost	0	0	12	162	1315
Mars Surf outpost	0	0	20	970	9206
<b>propellant &amp; life support water per year (MT)</b>	<b>2010</b>	<b>2025</b>	<b>2040</b>	<b>2055</b>	<b>2070</b>
LEO depot	2	433	2385	3096	23321
EML1 depot	0	425	3133	5534	43158
Moon Surf depot	0	13	482	771	4665
Phobos depot	0	5	328	1577	12084
Mars Surf depot	0	0	342	1720	12230

*Note: The table above is the cumulative demand forecast for water at each node point per time unit*

### Industrialization of Space<sup>222</sup>

The lower costs for space activities that is made possible through reuse and refueling with lunar propellant are a win-win for everyone in the industry, especially as markets and product lines expand. Combined with PPPs, they enable boots on the Moon and Mars without having to abandon ISS. Government agencies will simply be able to accomplish more with their existing budgets by leveraging the elements that make up the lunar propellant architecture. This will amplify opportunities for government infrastructure investments such as Mars Base Camp in Figure 82 that would leverage commercial cislunar activities.



**Figure 82: Lockheed Martin’s Mars Base Camp<sup>223</sup>**

With NASA able to focus its budget exploring and pushing the boundaries of new frontiers, the private sector will begin establishing the in-space industrial base required to support such missions. Commercial practices will sustainably produce the power, propellant, raw material, and services that will support both government and further private development of space. Jeff Bezos has shared a vision of the types of

<sup>222</sup> Section Author: Brad Blair, New Space Analytics, Managing Partner

<sup>223</sup> Image Credit: <https://www.lockheedmartin.com/en-us/products/Mars-base-camp.htm>

activities that will be possible in space as this industrial base evolves. These activities will not only benefit the economies of Earth, but also help safeguard its natural environments and resources.

*“Right now, everything that we take into space, we make here on Earth. At some point in the future, we’ll start to take advantage of useful bulk materials in space. Maybe we’ll have a good source of water that we can find in space, and we can break that down and use it to make bulk fuel, and oxygen, and propellant. At that point, we’ll cover bulk elements that we’ll get from space, but we’ll still bring all the “vitamins.” It’s going to be a long time before we can make microprocessors and solar cells in space, so we’ll make the microprocessors here on Earth, and we’ll cart them up from Earth into space. But there will be an inversion, I predict. This is a long-scale prediction. Eventually, all the giant silicon fabs and so on will operate much more efficiently in space where they have access to nearly unlimited energy supplies and nearly unlimited raw materials, and then we’ll send the vitamins back down to Earth. We’ll make all of our vitamins in space and we’ll just send the microprocessors down to Earth. Then Earth can eventually be zoned residential and light industry, and we can move all of our heavy industry off planet where it belongs, where it has easy access to solar power and other forms of energy.” [159]<sup>224</sup>*

This vision entails a radical expansion of the aerospace industry. Lunar propellant and decreased transportation costs in space are vital to enabling the types of grand industry described above. Without it, the concept of relocating heavy industry to space is simply not feasible. The commercial lunar propellant production facility is the first step to creating the economically fertile environment in space that will yield solutions to many of the challenges that face humanity today.

### **Science Benefits<sup>225</sup>**

Commercial mining on the Moon will provide tremendous scientific and exploration benefits in alignment with the goals of NASA and other national space agencies, both near-term and long-term. First, there is a direct and proven correlation between economic activity and scientific progress. Economic geology has provided far more data from Earth’s crust than purely academic geology could afford. Stanford Professor of Economic Geology, C.F. Tolman [160], gave examples of this including the following (bold added):

- Descriptive paleontology, especially of microfauna, has grown rapidly since laboratories were established by the **oil companies** for studying the fauna as an aid to the working out of the stratigraphy of the **oil fields**...
- The stratigraphy and the compilation of the geological column in the **oil fields** has been worked out in greater detail than would have been possible for investigators without the facilities given the geologist by **the operating companies**...
- Ralph Reed’s book, *The Geology of California*, is a compilation chiefly of the detailed work of the **oil geologists and paleontologists** because most of the detailed work in California geology has been done by them...
- Since the Great War the greatest advances in ore deposits is due to the development of special detailed method of underground mapping in **mines**...
- Finally, ground water hydrology...one of the important specialized fields of **economic geology**. As an example...the Hawaiian Islands...This detailed mapping of the ground water geologist has

---

<sup>224</sup> <https://www.geekwire.com/2016/interview-jeff-bezos>

<sup>225</sup> Section Author: Philip Metzger, University of Central Florida, Planetary Scientist

furnished us pictures of the structure of the Hawaiian volcanoes which could not be obtained by any other method of investigation.

The US Bureau of Labor Statistics shows that 65% of jobs are in direct economic activity such as mining, 18% are in research (largely supported by economic interests), 12% are in government (mostly managing economic activity), and only 5% are in academia (supported by the tuition of students going into primarily economic geology). Gantman [161] studied the scientific publishing records of individual scientists in 147 countries and showed they are more productive in countries that (1) have extensively larger economies and (2) have intensively better-developed economies, the two factors being statistically independent. This will also be true for the country we call “space”. As the in-space economy grows in extent and intensity it will, just like national economies, channel more funding into science to gain its benefits while providing better tools and access to opportunities enabling more scientific success [162]. Mining lunar volatiles will provide vastly more access to the lunar subsurface including volatiles than could be achieved through taxpayer-supported budgets of national space programs. Geologists will be working for the extraction companies modeling lunar deposits to maximize mining yields. These models will be based on research to understand formation of the deposits through solar system history, addressing fundamental questions of science. NASA will be – like the US Geological Survey – far more productive when it works cooperatively with these economic interests than it could ever be working alone.

Lunar mining will also make a lunar outpost far more affordable and sustainable. Consumables such as rocket propellant, breathing air, and water will be more affordable. Cislunar transportation systems, communications systems, in-space manufacture of spare parts, and other infrastructure will be supported by other customers, removing them from NASA’s budget. (Other customers include the boosting of telecommunications satellites from LEO to GEO using lunar propellant, support of tourist activities in cislunar space and on the lunar surface, and manufacture of large antenna systems in Earth orbit that are too large to launch.) The lunar infrastructure will enhance NASA’s capabilities while increasing safety. Astronauts at the lunar outpost will perform geological research and technology development tasks that support further economic development in space, establishing a virtuous cycle.

Lunar mining will support exploration and science far beyond cislunar space. Examples include providing in-space propellants to boost larger spacecraft to the outer solar system, providing materials to manufacture larger antenna arrays in space to return higher data rates from the outer solar system, supporting radioastronomy in the radio silence of the far side of the Moon, and providing the infrastructure that all science depends upon. Crawford explained the terrestrial analog: “astronomers, geologists and zoologists invariably make use of an extensive commercial aviation infrastructure (which, of course, is largely underpinned by the tourism industry) in order to visit their observatories and field localities, without having to design, build, and operate commercial airliners. This is not a trivial point: because scientific budgets would be wholly inadequate to develop such an infrastructure, if it had not been created for other reasons, then a lot of scientific activity on Earth simply could not occur. Future scientists operating on the Moon, Mars and asteroids (and indeed throughout the solar system) would similarly benefit from a commercial interplanetary transportation infrastructure” [163].

NASA’s current plans are for “Sustainable Exploration” as shown in Figure 83. Related NASA documents describe how every mission must leave some infrastructure behind to build upon. However, maintaining infrastructure is expensive, including skills retention of the people who designed and operated it, so as infrastructure increases, costs increase and Mars missions likely remain unaffordable to NASA. The program of sustainable exploration can work only if there is increasing commercial cash flow from new businesses so infrastructure is sustained by customers other than NASA. Then NASA can spend its limited budget on the other activities also needed to reach Mars. In other words, NASA’s program of

Sustainable Exploration is nothing other than the development of civilization in a region until its commercial economy supports science. It is an acknowledgement of the findings of Tolman and Gatman discussed above, that economic activity produces more science than taxpayer-funded academic science can produce. When the vast majority of space scientists like the vast majority of geoscientists (US Bureau of Labor Statistics) are supported by economic activity, then space science will be sustainable.

### STRATEGIC PRINCIPLES FOR SUSTAINABLE EXPLORATION



- **FISCAL REALISM:** Implementable in the near-term with the buying power of current budgets and in the longer term with budgets commensurate with economic growth;
- **SCIENTIFIC EXPLORATION:** Exploration enables science and science enables exploration; leveraging scientific expertise for human exploration of the solar system.
- **TECHNOLOGY PULL AND PUSH:** Application of high TRL technologies for near term missions, while focusing sustained investments on technologies and capabilities to address the challenges of future missions;
- **GRADUAL BUILD UP OF CAPABILITY:** Near-term mission opportunities with a defined cadence of compelling and integrated human and robotic missions, providing for an incremental buildup of capabilities for more complex missions over time;

- **ECONOMIC OPPORTUNITY:** Opportunities for U.S. commercial business to further enhance their experience and business base;
- **ARCHITECTURE OPENNESS AND RESILIENCE:** Resilient architecture featuring multi-use, evolvable space infrastructure, minimizing unique developments, with each mission leaving something behind to support subsequent missions;
- **GLOBAL COLLABORATION AND LEADERSHIP:** Substantial new international and commercial partnerships, leveraging current International Space Station partnerships and building new cooperative ventures for exploration; and
- **CONTINUITY OF HUMAN SPACEFLIGHT:** Uninterrupted expansion of human presence into the solar system by establishing a regular cadence of crewed missions to cis-lunar space during ISS lifetime.

4

**Figure 83: NASA’s Principles for Sustainable Exploration**

*Description of in-space economic development supported by commercial interests so that NASA can benefit from in-space capabilities without covering their expenses<sup>226</sup>*

### Long-Term Benefits<sup>227</sup>

Mining for water on the Moon is a first step toward establishing an industrial supply chain outside Earth’s gravity well. Such a supply chain will have long-lasting positive benefits for human welfare, for the Earth’s environment, and for national security (global stability). Seeking these benefits is the role of government. This provides strong motivation for government leaders to prime the pumps of lunar industry, helping it through the early stages as quickly as possible until adequate financing and cash flow make it economically self-sustaining. Five of the expected benefits are reviewed briefly below.

#### Energy

It has been known for several decades that it is physically and technologically feasible to collect solar energy in space and beam it safely to Earth by microwaves 24/7 because the solar cells will be located outside Earth’s shadow during the night, a concept called Space Based Solar Power (SBSP). It has been argued that SBSP is not economically viable because launching the energy-collection and power-beaming

<sup>226</sup>[https://www.nasa.gov/sites/default/files/atoms/files/strategic\\_principles\\_for\\_sustainable\\_exploration.pdf](https://www.nasa.gov/sites/default/files/atoms/files/strategic_principles_for_sustainable_exploration.pdf)

<sup>227</sup> Section Author: Philip Metzger, University of Central Florida, Planetary Scientist

infrastructure from Earth's surface into space is far too costly to compete with carbon-based energy. Recently, it is argued by some that SBSP cannot even compete against terrestrial renewable energy for providing baseload power. Battery prices are dropping dramatically so it seems we can store solar energy for use as baseload power at night, and a smart grid with other energy sources including wind can eventually make renewable energy competitive even against carbon-based energy without resorting to energy collected in space. However, this line of argument assumes we will launch the entire SBSP infrastructure into space from Earth making it very expensive.

Once a robotic industrial supply chain is established in space, it becomes inevitable that SBSP will be constructed in space eliminating much Earth-to-orbit launch costs<sup>228</sup>. Initially, this could be lunar propellant delivered to LEO to raise SBSP elements from LEO to GEO. Eventually, lunar regolith may also be a part of SBSP construction. Regolith, a possible byproduct of lunar propellant processes, can be sintered into usable forms<sup>229</sup>. Structural components of the kilometer-sized SBSP stations could be delivered from the Moon to GEO at a fraction of the cost of launching them from Earth. It will become the cheapest form of energy because it eliminates the need for any energy storage at all (reducing energy costs by perhaps a factor of five), and it essentially eliminates land use for energy collection freeing the land for agriculture or other purposes. (Collection of the beamed microwaves can occur over cropland, forests, or oceans, permitting dual use of land that has tremendous economic value.) At that time, SBSP will outcompete the terrestrial-based energy sector, including carbon-based, nuclear, and renewable. This will enable not just energy collection to move off Earth's surface, but the entire fraction of the economy that support the energy sector: all the mining, manufacturing, and construction of facilities to make the equipment, materials, and parts needed by the energy sector, plus all the factories that make those goods, plus the factories that make those factories, etc. Considering the lower Energy-Return-On-energy-Invested (EROI) for an energy sector that is 100% renewable, and considering what fraction of Earth's industrial supply chain is needed to support that energy sector, it is plausible that a fourth of civilization's ecological footprint can be moved off-planet for this one purpose alone. This does not even take into account the tremendous growth of energy demand because of the exponential growth of computing extrapolated to the end of the century as discussed below. Obviously, moving one fourth of our footprint off-planet will provide a benefit to Earth's environment that is almost impossible to exaggerate by the end of the century.

Low cost, abundant energy also enables economic growth globally, improving the conditions of humanity and supporting global political stability. The key to making it happen is simply initiating the growth of the in-space industrial supply chain, so the infrastructure that eventually builds SBSP will be funded in stages by a natural series of self-supporting profitable activities, not by attempting to build the entire, expensive infrastructure today by direct investment. The only missing piece is the modest government investment that gets the entire process started through mining lunar volatiles. Since lunar mining also makes NASA immediately more effective at its core purpose and has other immediate benefits, it is a no-risk investment in our future. The sooner it happens, the sooner this space-based solution can contribute to the well-being of Earth, and time is of the essence. It is feasible to have economic SBSP within several decades if we begin today. Government leaders who have the vision to make this happen will have an enduring legacy.

Other resources that are scarce, such as Rare Earth Elements or Platinum Group Elements, can also be mined in space and brought back to Earth. However, if adequate energy is delivered to Earth at low cost,

---

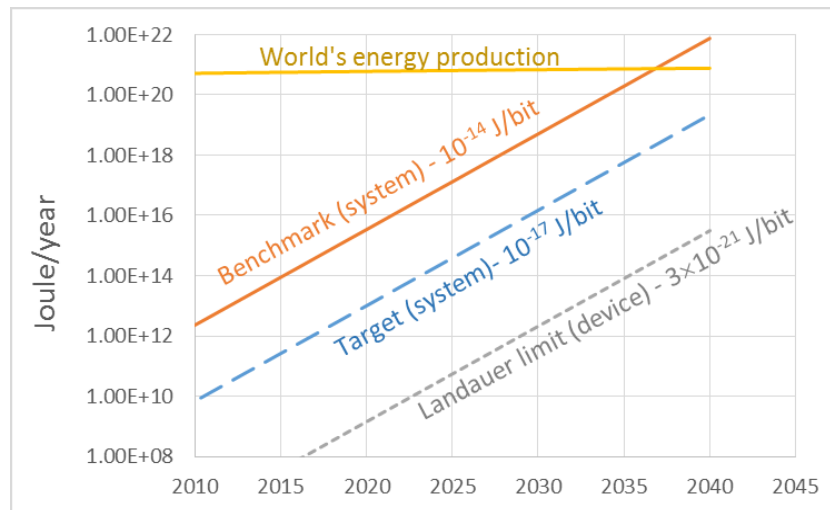
<sup>228</sup> John C. Mankins, *The Case for Space Solar Power*. Houston, TX: Virginia Edition Publishing, LLC, 2014. ISBN 978-0-9913370-0-2.

<sup>229</sup> [http://www.isruinfo.com/docs/microwave\\_sintering\\_of\\_lunar\\_soil.pdf](http://www.isruinfo.com/docs/microwave_sintering_of_lunar_soil.pdf)

recycling all the materials on Earth can be the first line of defense against resource scarcity. Low-cost abundant energy is the one resource that solves most of the other resource problems.

### Computing and Data

Computing is growing exponentially, which means the energy needs of computers are growing exponentially as shown in Figure 84. Per a study by the Semiconductor Industry Association and the Semiconductor Research Corporation [164], the current rate of growth indicates that by 2037 computing will require the entire world's production of energy. If the hoped-for improvements in computing efficiency are achieved, they will delay that date only by 8 years.



**Figure 84: Growth of Computer Energy Usage Compared to World Energy Production**

*Credit: Semiconductor Industry Association and Semiconductor Research Corporation. The Benchmark System represents current computer technology. Target system represents desired improvements in energy efficiency. Landauer limit is the theoretical maximally efficient computer, which is not practical to achieve.*

Many experts in AI foresee no abatement in this growth. Although the human population may level out at about 11 billion by the end of the century [165] [166], the amount of AI may grow into the trillions of equivalent human minds [167]. This will lead to server cities becoming the powerhouses of economic activity, consuming vast energy and material resources along with their concomitant supply chains, generating not only information but also tremendous heat that must be pumped into the atmosphere and oceans. All this impact to Earth's environment can be avoided if we develop an in-space supply chain quickly enough. That will enable us to put most of the computing sector, along with the energy sector, into space. Data is a unique economic product because it can be masslessly uplinked and downlinked between Earth and the off-Earth server cities. Large microwave antenna systems (along with laser communications) can be constructed in space by this same supply chain to enable high spatial diversity (small beam spots) for high data rates independent of weather conditions, with safe power levels at Earth's surface, to make it possible. While we cannot predict any details of our future, it seems inevitable that computing must begin moving off-Earth as early as possible in this century for Earth to remain healthy to the end of the century. Again, this is a historically unique opportunity for visionary leaders to forge a legacy that will last.

### Existential Threats

One of the lessons of 20<sup>th</sup> century science is that space is a dangerous place and that we rent our living space on Earth temporarily between extinction events. A planet-scale civilization, even fully developed, lacks the ability to change this situation. Only a solar-system scale civilization is capable of making our



existence on a planet safe. The primary dangers that can be addressed on a solar system scale are from asteroid and comet impacts. While the largest asteroids that might impact Earth have already been mapped, a long period comet could suddenly appear on a collision course and there would be no adequate time to respond. While the odds may be relatively low compared to the lifespan of a single human, over the lifespan of a species it is not insignificant. The “expectation value” of these events as calculated in games involving chance, for example, is the probability of the event multiplied by the magnitude of its effect. Since many billions of current and future lives would be lost in an extinction event, the expectation value of harm from these rare events is actually quite high and well worth the cost to avoid.

Other existential threats to humanity are contained within the Earth itself, such as the Yellowstone Hot Spot erupting, which although would not extinct human life could kill billions and force a dangerous reboot of global civilization. The only way we could deal with threats on these scales is to have an economy on equivalently gargantuan scales, which is not possible within the spatial and energy limitations of a planet. However, once a supply chain is initiated outside the planet with robotic labor and solar system-scale resources, it will take only a few decades for it to expand itself through exponential growth to the scale necessary to make human life, and all species of life, safe on a planet in our region of space [168] [169]. This may have seemed like science fiction in the past, but the emergence of robotics and the prospects for putting industry in space have made this a reality we can address today. Moreover, since initiating a space industry also has immediate benefits for NASA and is affordable within the cost of NASA’s existing budget, it is a low-risk bet. After half a millennium, we still remember that it was Queen Isabella who funded Columbus to cross the Atlantic. Similarly, this is a historically unique opportunity for leadership to change the world and earn a place in cultural memory that may last perhaps as long as our species lasts.

### **National Security and Global Stability**

History both ancient and recent show civilizations that are industrially strong tend to be geopolitically dominant, conquering their neighbors when they desire, or resisting conquest when they must. Nations that lack resources to grow industry, or whose populations have been reduced by disease, are at risk. Space industry has the potential to create the greatest imbalance of power in human history. Since the solar system has literally billions of times the resources in energy and material compared to the surface of Earth, any nation that creates a robotic in-space supply chain capable of exponential growth will have unlimited labor (robotics) and industrial growth to dominate all the other nations of Earth. There would be essentially no way to initiate space industry as a second-comer to catch up in the face of their rapidly growing dominance of the most available space resources.

Because robotics are advancing so rapidly, and because space is becoming more accessible with lower cost launches, it is inevitable that some nation soon will start industry in space. The only way to prevent their using this for military advantage to dominate others is to ensure that it is a collaboration of benevolent nations that gets there first. The lunar volatile deposits are unique in making it possible to start space industry. They are near Earth, yet outside Earth’s gravity well; they are adjacent to near perpetual sunlight; and they are the most economically usable resource for the initiation of space industry. These limited locations in space are arguably the most valuable and militarily strategic real estate in the solar system. It has been argued that a single nation could leverage existing treaties to claim the entirety of these locations for themselves [170]. This situation, too, presents a historically unique opportunity for leadership to emerge, demonstrating vision that makes the world a better place and earns themselves a place of honor in perpetuity.

### **Grand Science and Exploration**

Just as there are threats that are beyond the reach of solving for a mere planet-scale economy, so there is science and exploration beyond its reach, too. The horizons of humanity will grow far beyond anything

we thought possible when our civilization's economy grows exponentially in space for just a few decades. Soon we can create distributed telescopes as large as the diameter of Earth's orbit, capable of spotting an automobile on the surface of an exoplanet 100 light years away [171]. We could build planet-sized particle colliders on Mercury powered by solar energy for essentially no cost from any national budget. We could build multi-generation world ships to visit other stars, and we could send robotic "spore" ships ahead to create space industry in those star systems and terraform planets or build cities in anticipation of our arrival. These activities and many more do not require any exotic physics to achieve, only the much larger economies that space industry will provide, and will do so while not harming the Earth but instead repairing it. Modeling of space industry shows that these possibilities are achievable perhaps by the end of this century [168] so our children and grandchildren will know them as reality if we start today, and we can have the tremendous satisfaction of knowing that we made it possible and saw it starting in our lifetimes.



## **Recommendations**

## **For Government<sup>230</sup>**

In order to establish a successful lunar propellant plant and fully realize all of its associated benefits requires private and government collaboration. The combined strengths of these players can be leveraged to create the healthiest and most sustainable space endeavor ever undertaken. A freely competed commercial propellant plant employing the US industrial base supported by PPP with Congress, NASA, DARPA, and other US government agencies represents humanities most capable partnership for propelling Earth based economies into the expanses of space. The following section will outline some of the fundamental roles that the US government should take to create this lasting space capability. The challenge is finding ways for the USG to encourage and stimulate the development of a commercial economy without managing it as a common economy.

The role of NASA should include providing scientific exploration of the Permanently Shadowed Regions (PSR) of the Moon, assisting in developing early stage technologies and serving as an anchor customer of in-space propellant by proposing a price, quantity, and location of use. US government laboratories should assist in the development of required technology by providing support to commercial companies. Both NASA and other US government laboratories can also help facilitate demonstrations including fully Integrated System Tests (IST)s of a pilot plant. Finally, Congress should play a pivotal role in the creation of regulation and law that is enabling for a Commercial Lunar Propellant Architecture. All of these recommendations are discussed in more detail in the following sub-sections.

### **Develop Precursor “Prospecting” Missions<sup>231</sup>**

Prospecting (or scientific exploration) of the lunar polar regions is critical to building the foundation for a commercial lunar propellant plant. In addition to quantifying the abundance and concentration of the water ice deposits, there is a need to understand the environment as well. The designs of the extraction and transport systems are highly dependent on knowing what conditions actually exist at the mining site. The focal areas for precursor prospecting missions to explore should be:

1. Resource-related properties. We know from the Clementine, LCROSS, Chandrayaan-1, and LRO data<sup>232</sup> that there is water ice in significant quantities in lunar polar craters. What is unknown is the distribution of water there, how deep it goes, and how well the regolith conducts heat (which would help with getting heat down to ice deeper in the regolith).
2. The surface environment. In order to transport equipment around to build the site, as well as transporting the product around, it is important to get more details on surface conditions, such as: how firm or soft is the surface; how easily is dust stirred up; what sizes of obstacles are likely to be encountered.
3. Stability. The surface of the Moon is not static. Micrometeorite impacts are frequent enough to create a small but measurable dust content<sup>233</sup>. Regolith on the sloping crater walls might collapse periodically similar to avalanches—especially with the increased vibrations coming from construction and transport activities. These conditions need to be assessed to design a safe facility, manage the dust problem, and include adequate protection from micrometeorite impact.

The detailed recommendations for lunar volatile prospecting have been addressed in the CSM publication that was developed during the 2018 Space Resources Roundtable workshop. These

---

<sup>230</sup> Section Author: David Kornuta, United Launch Alliance, CisLunar Project Lead

<sup>231</sup> Section Author: Gordon Roesler, Robots in Space LLC, President

<sup>232</sup> Ice On The Moon, [https://nssdc.gsfc.nasa.gov/planetary/ice/ice\\_Moon.html](https://nssdc.gsfc.nasa.gov/planetary/ice/ice_Moon.html)

<sup>233</sup> [https://www.lpi.usra.edu/leag/science\\_nuggets/LADEE\\_sciencenuggets.pdf](https://www.lpi.usra.edu/leag/science_nuggets/LADEE_sciencenuggets.pdf)

recommendations can be found in the Lunar Polar Prospecting Workshop: Findings and Recommendations [172]<sup>234</sup>.

### **Develop Prototype Pilot Plant on Earth**<sup>235</sup>

The commercial lunar propellant plant will require a multi-billion-dollar capital investment. One-step in attracting this level of investment and proving the technology might be a smaller, lower-cost pilot plant on Earth. Given how a plant would have to be customized for lunar operations (modularization, weight reduction, safety, redundancy, and sparing, robotic assembly) a pilot plant would have a very positive impact on risk reduction and investor confidence. Most of the robotic operations could be demonstrated on Earth. Once the properties of the resource on the Moon were measured, extraction operations could be performed separately in a cryogenic vacuum chamber. It might also be desirable to install a pilot plant on the Moon itself, prior to starting construction of the industrial-scale commercial production facility.

### **Institute Public Private Partnership**<sup>236</sup>

We believe the establishment of a lunar ice mining operation is a great opportunity for a PPP. As was the case with NASA's Commercial Orbital Transportation Services (COTS) program, all the elements for success are present.

*"Significant cost reductions from the norm of cost-plus contracting are possible for new space system elements in NASA's exploration scenarios. ... There is no basis to conclude that public private partnerships end at low Earth orbit, prohibited or incapable of going beyond that point to deep space, the Moon or Mars." [173]<sup>237</sup>*

First is a legitimate government need for the service. As stated earlier, NASA's program to return to the Moon as well as operate in cislunar space assembling Mars exploration vehicles will benefit tremendously by the availability of low cost propellant on the Moon. As described in the Demand section, propellant purchased on the lunar surface represents a tremendous savings compared to bringing it from Earth. In addition, NASA will need oxygen and purified water, both products of the mining operation.

Second is a defined commercial market for the product. As shown earlier, the commercial GEO satellite industry may drive the purchase of large quantities of propellant in LEO. If this demand is successfully met, other demands will emerge. For example, SpaceX has baselined refueling for its Big Falcon Rocket (BFR) rocket. Though the BFR uses methane fuel, LO<sub>2</sub> represents a large fraction of its propellant mass. Blue Origin is also interested in refueling both its third stage and Blue Moon lander use LO<sub>2</sub>/LH<sub>2</sub> propellants.

With these two ingredients, the PPP can be structured as a fixed NASA investment into a commercially led mining operation development with a NASA commitment to purchase commodities in some amount. By specifying a price and quantity guaranteeing propellant purchases on the lunar surface, the wheels of American innovation and creativity can be set in motion to create capabilities NASA could not afford on its own. Capabilities that will underwrite a massive expansion of the human species into an entirely new environment. Annually increasing the price until the market responds with the needed capability is one method that could be used to overcome unseen difficulties along the way. To avoid picking winners and let the free market work more efficiently, it might be sufficient for NASA to commit to buy commodities (without investment) to stimulate the private sector to make the investment on its own. Many of these ideas have been discussed extensively. See, for example, the Lunar COTS proposal from [174]<sup>238</sup>.

---

<sup>234</sup> [http://isruinfo.com/docs/LPP\\_2018\\_final\\_report.pdf](http://isruinfo.com/docs/LPP_2018_final_report.pdf)

<sup>235</sup> Section Author: Gordon Roesler, Robots in Space LLC, President

<sup>236</sup> Section Author: George Sowers, Colorado School of Mines, Professor of Space Resources

<sup>237</sup> <https://ntrs.nasa.gov/search.jsp?R=20170008893>

<sup>238</sup> [https://www.nasa.gov/sites/default/files/atoms/files/aiaa2015-4408zunigalunarcotspaper\\_0.pdf](https://www.nasa.gov/sites/default/files/atoms/files/aiaa2015-4408zunigalunarcotspaper_0.pdf)

### Promote Healthy Competition<sup>239</sup>

Though there are many positive impacts to the efficiency, cost reduction, and growth of a freely competed market, there can also be destructive effects depending on the diversity and abundance of customers. Historically, in cases where there is a single high stakes, high value customer to be won, fierce competition can evolve that sometimes hinders the growth of an economic ecosystem. Table 25 [152] depicts the differences between healthy competition (cooperative challenges) and cutthroat competition (competitive challenges). Although either of these approaches can be pursued within a privately competed lunar mine, healthy competition can be encouraged and established early on if the initial government customer strategically structures their propellant procurement process.

**Table 25: Stages in the Development of a New Business Ecosystem**

<b>The Evolutionary Stages of a Business Ecosystem</b>		
	<b>Cooperative Challenges</b>	<b>Competitive Challenges</b>
<b>Birth</b>	Work with customers and suppliers to define the new value proposition around a seed innovation.	Protect your ideas from others who might be working toward defining similar offers. Tie up critical lead customers, key suppliers, and important channels.
<b>Expansion</b>	Bring the new offer to a large market by working with suppliers and partners to scale up supply and to achieve maximum market coverage.	Defeat alternative implementations of similar ideas. Ensure that your approach is the market standard in its class through dominating key market segments.
<b>Leadership</b>	Provide a compelling vision for the future that encourages suppliers and customers to work together to continue improving the complete offer.	Maintain strong bargaining power in relation to other players in the ecosystem, including key customers and valued suppliers.
<b>Self-Renewal</b>	Work with innovators to bring new ideas to the existing ecosystem.	Maintain high barriers to entry to prevent innovators from building alternative ecosystems. Maintain high customer switching costs in order to buy time to incorporate new ideas into your own products and services.

Examples from other industries show the benefits of openness and information sharing. One positive example is the microwave communications industry. Microwave conferences began to be held in 1953, with competitors sharing the results of their research and collaborative discussions of new trends and developments. As a result, microwave transmission was the dominant form of high-data-rate communications for decades.

For lunar propellant production, it is also true that the benefits of a collaborative and healthily competed commercial capability substantially outweighs an approach that is dominated by a single “winner”. Multiple vendors can increase the likelihood of a robust and reliable future supply chain that funds continuous innovation and capacity enhancement. Technological and operational capabilities can also benefit from the diversity of approaches a competitive ecosystem can draw.

---

<sup>239</sup> Section Authors: Brad Blair, NewSpace Analytics, Managing Partner; and David Kornuta, United Launch Alliance, CisLunar Project Lead

*“Jeff Bezos, founder of Blue Origin and Amazon, comments that...competition should not be cutthroat to determine future monopoly...but creating an ecosystem for other entrepreneurs to thrive upon.” [142]<sup>240</sup>*

Early on, healthy competition can be promoted through the purchasing strategy of the government customers described in the Lunar Surface and EML1 Customers section. The total demand proposed by these initial government customers should be divided among multiple commercial providers. Although this may make it more challenging to close the business case for these early companies, it will encourage them to develop even more lightweight, efficient, and creative solutions. In addition, it will stimulate the establishment of multiple providers that will pursue and cultivate new customers and uses for their products. Once additional customers, both government and commercial, are established, free market competition will continue to evolve with the lunar propellant industry.

### **Facilitate Technology Development<sup>241</sup>**

Various US Government laboratories have technologies that would be very useful in the commercial lunar propellant plant. These technologies could augment the development efforts within US aerospace companies. Partnerships with the US Government or its departments could accelerate the plant design. Some examples of applicable efforts:

- Air Force Research Laboratory: modular and “plug-and-play” satellite design
- Naval Research Laboratory: automated space robotic operations
- Jet Propulsion Laboratory: mobility on planetary surfaces
- Langley Research Center: in-space assembly techniques and hardware
- Marshall Space Flight Center: in-space manufacturing

Some cooperative efforts between government and industry have resulted in additional capabilities that could be used. NASA’s Tipping Point program has invested in three efforts that could provide robotic assembly and construction capabilities (see the Lunar Surface Construction, Maintenance, and Repair section of this paper). DARPA’s RSGS program<sup>242</sup> is developing autonomous failure response algorithms that could be adapted for use during facility construction and operation. In addition, the following technology areas identified in this paper would greatly benefit from government support:

- Volatile sublimation and capture in a vacuum
- High efficiency electrolysis
- Improved cryogenic management systems for in-space storage
- Ultralight, high efficiency solar panel masts
- Ultralight deployable solar reflectors
- Microwave and laser power beaming
- MW class space rated fission reactors
- Extreme cold and dust tolerant robotic actuators/components
- Autonomous control systems and machine learning
- In-space rendezvous, grappling, and propellant transfer
- Lunar communications architecture
- Refuelable, large, LO2/LH2 autonomous lunar landers
- Refuelable LO2/LH2 in-space transport

---

<sup>240</sup> <https://doi.org/10.1089/space.2017.0032>

<sup>241</sup> Section Author: Gordon Roesler, Robots in Space LLC, President

<sup>242</sup> <https://www.darpa.mil/program/robotic-servicing-of-geosynchronous-satellites>

- Propellantless ascent options from the lunar surface
- Aerobraking and aerocapture in Earth’s atmosphere

**Institute Law for Property Ownership<sup>243</sup>**

Because legal certainty allows a private entity the ability to know its costs and its potential return on investment, to attract investors, and to plan, U.S. recognition of a private entity’s property interests would advance exploration, investment, and U.S. leadership. Congress should consider codifying the principles of adverse possession as a means of ensuring legal certainty. Typically, adverse possession principles provide an analytical tool for figuring out if a person occupying someone else’s land should be allowed to take it from the original owner. However, some of the elements may be useful for robotic lunar mining as well.

For example, Congress could enact legislation recognizing that a company’s human or robotic presence and control over a particular portion of terrain if the presence and control was continuous, open and notorious, actual, and exclusive for three years (or some other number), meant the company was recognized as the owner of the land.

This particular proposal would require more analysis to flesh it out fully, and to review such historical analogs at the U.S. 19th century Homesteading and Mining Acts.

**For Private Sector<sup>244</sup>**

The US industrial base is fully capable of tackling the technical challenges of a lunar propellant plant. In addition, a free market strategy for implementing this capability is critical to its longevity. Private organizations need to establish sustainable business models in order to maintain operations. Costs and commodity prices are bound by investors’ and customers’ availability and willingness to pay. Stakeholders in private enterprise hold companies accountable to generate revenue and produce returns while maintaining competitive edge. Therefore, it is recommended that this effort have significant private sector involvement and investment to ensure the sustained interest and active business development required at the foundation of an entirely new industry with government creating the environment where commercial entities can flourish. The following sections will outline recommendations to the private sector concerning leadership, competition, investment, and participation in the development of space law.

**Establish Leadership within the Private Sector<sup>245</sup>**

The development and implementation of a commercial lunar propellant plant is a long-term investment strategy with incredible growth potential. As described throughout this study, the hardware solutions are well on their way to maturity. However, these hardware solutions are being developed by a multitude of companies for a variety of applications. It is only through the vision of the commercial lunar propellant plant that they are currently stitched together. To ensure that the development and implementation of this system is successful, it is necessary for leadership and organization of the many constituent parts of the architecture.

It is highly recommended that this leadership be established within the private sector to maintain competitive, innovative, profit generating solutions throughout all phases of development. To reap the benefits of free market competition, multiple companies should be encouraged to take on the role of system integrators for competing lunar propellant mines. These private entities may or may not exist today but are necessary to administrate the many subcontractors similar to those identified in this study. In addition, the administrating companies would interface with investment firms, government agencies, and international

---

<sup>243</sup> Section Author: Laura Montgomery, Catholic University’s Columbus School of Law, Professor of Space Law

<sup>244</sup> Section Author: David Kornuta, United Launch Alliance, CisLunar Project Lead

<sup>245</sup> Section Author: David Kornuta, United Launch Alliance, CisLunar Project Lead



organizations to generate funding, facilitate technology development, and establish the customer base required to close the business case. In order for these “Commercial Lunar Propellant Companies” to be successful, government support would also be crucial.

To encourage and stimulate these privatized activities, the government should incorporate the operation into future space architectures, continue to fund development of applicable technologies, implement the legal framework to support commercial lunar activity, and establish a baseline lunar propellant demand and price as the anchor customer. This relationship was described in detail in the For Government section above. With a foundation in the free market, and with continued support from NASA and the US government, the commercial lunar propellant plants will establish the first permanent foothold for US economic opportunities on the Moon.

### **Strategize for Investment Appeal<sup>246</sup>**

The following sections discuss several strategic recommendations that an emerging commercial lunar mining company should utilize to better posture themselves for investment appeal. These strategies include high fidelity financial modeling, establishing insurability, diversifying applications, and incremental deployment. In addition to promoting investment appeal, these strategies are critical steps towards the realization of this emergent industry.

A third party economic study of the commercial lunar propellant plant is essential to proving financial feasibility to the investment community and should be created. A high fidelity financial model contracted to an unbiased, reputable institution would be ideal. Within the high fidelity model, detailed inputs from the constituent companies should be stitched together. This data should include detailed cost, scheduling, and financial information provided for unbiased review and incorporation into the model. The model should treat each element of the lunar propellant plant as a subcontracted item that would be provided by the most capable companies. This high fidelity economic model will be a major element in communicating the investment value of the commercial lunar propellant plant as an integrated system.

There is a close relationship between the willingness of investors to contribute to product development and the assessments of insurance underwriters. Investors will generally favor opportunities that are judged insurable. An early dialogue with the insurance underwriting community will be beneficial in the system design process. For example, understanding what are considered the highest consequence failures by the insurers will assist the designers in including the appropriate amounts of redundancy and the selection of components that meet the required standards.

It is easier to attract investment to technology development for a mining enterprise if those technologies are not unique to that enterprise. The development program should emphasize the use of technologies that will have multiple applications. For example, space robotics can be used in markets other than lunar propellant—servicing of orbiting satellites, construction of large space structures, and in-space manufacturing. Developing technologies that can also be applied to terrestrial operations opens up an even greater variety of markets. Examples of applicable terrestrial markets include uses in deep-sea resource exploration, remote research, mining, and military operations, as well as the automation of complex industrial processes. Investors are more willing to fund technology development if they can see multiple avenues for return on their investment.

Investment is likely to be attracted incrementally as the production capability gains in maturity. A terrestrial demonstration facility will show that the selected technologies can work together. Building and

---

<sup>246</sup> Section Authors: Gordon Roesler, Robots in Space LLC, President; and David Kornuta, United Launch Alliance, CisLunar Project Lead

operating a demonstration or pilot plant (as describe in the Develop Prototype Pilot Plant section), will be key to raising confidence by proofing the system. A pilot plant on the Moon could also be important to attract investment, with the additional attraction that it would have some revenue generation capability, although less than the full-scale plant.

### **Promote Investment Opportunities<sup>247</sup>**

Akin to early investments in internet startups in the 1990's, the emerging space economy offers high reward investments. With a multitude of different systems and services necessary for the lunar propellant production plant, there is substantial opportunity for investment. Dependent on investment timeline, acceptable risk, and desired company profile, an investor can choose the type of venture that will best suit them in this emerging space operation. Among the potential suppliers of the hardware required for the lunar propellant architecture, there is a wide variety of company maturity, size, and ambition. To simplify, these variations can be classified into four categories of investment opportunity. These categories are described below in order of least risk to highest risk.

The first category consists of the legacy companies with current operations and mature technologies in the space sector. These companies have been established for over 20 years and usually have business operations in a variety of different fields. Companies in this stage are relatively low risk investments, but many are publicly traded companies with lower potential rewards from the growth of the space economy on a per shareholder basis.

The second category consists of space companies recently founded yet mature with focused operations solely on the space economy, such as ULA, SpaceX or Blue Origin. These companies have established their technologies and have proven flight systems which lowers the potential risk for investors, while still allowing for larger potential rewards in the future than legacy companies.

The third category is established startups. Companies that fall into this category usually have some established space technologies developed, well-defined business plans, and a strong core team in place. Not all of these companies have substantial investment yet. These companies are usually looking to move past the design phase, develop or further prototypes, or develop complementary technologies. This is a higher risk investment opportunity than the first two, but there are substantially large potential rewards for successful investments. Companies in this stage include Made In Space, Ispace, Astrobotic, NanoRacks, Masten Space Systems, and Lunar Outpost.

The fourth opportunity to invest is in seed stage companies. There are many companies in this category and differentiating the good investments from the bad can take some work. Investors should look for the companies that have technically feasible ideas, strong teams to develop the needed technology, and fleshed out business plans. While not always the case, successful investments in early stage companies can reap higher rewards in the future.

In an effort to provide a survey of how feasible ISRU on the Moon is, the CisLunar Marketplace Workshops have compiled a substantial database of enabling technologies and their current TRL. Augmented by industry and expert input, that database is the foundation of this study and ongoing discussions. As described in this study, the technologies necessary for lunar propellant production are currently developed or in development. This bolsters the investment prospects for all four stages of space companies.

---

<sup>247</sup> Section Author: Justin Cyrus, Lunar Outpost, CEO

Today, the technologies needed for space resource utilization with low TRL provide excellent opportunity for investment. Given the high maturity of complementary technologies, the support of visionary investors, focus from established and well-respected companies, and talented young startups, it is our recommendation that investment opportunities into space resources and supporting infrastructure be viewed as promising and worth the risk. Because lunar propellant production is equally valuable as a monetary or capability investment, it is equally valuable to private or government investors as well. The companies that succeed in this venture will not only help shape the space economy but also advance space exploration while improving life here on Earth for generations to come, and potentially reap substantial returns.

### **Active Role in Space Law<sup>248</sup>**

Companies intending to extract space resources from the Moon or any other celestial body will need legal certainty that:

1. They will have exclusive rights over a certain surface area of a celestial body where the resources extraction will take place
2. Their operations will be protected from interference from competing companies
3. They will have ownership rights over any extracted resources

Since Article II of the Outer Space Treaty is broadly seen as prohibiting ownership rights (whether sovereign or private ownership rights), mining companies should be prepared to work with international organizations (such as the Hague Working Group on Space Resources). These organizations are currently seeking to formulate a method of providing companies with exclusive mining rights (which could be something less than property rights). Regarding non-interference with existing mining operations, existing international law already contains a requirement that space operators carry out their activities with “due regard” for the activity of others. However, international organizations are similarly occupied with creating a clearer international understanding of how interference can be best avoided. Industry input is critical as these details are worked out. With respect to the ownership of extracted resources, international law is rather clear that the mining company may assert such ownership rights. This interpretation of international law has been bolstered by domestic legislation in both the United States and Luxembourg. That said, companies should continue to monitor and be involved in any new legal developments on this topic.

### **Technical<sup>249</sup>**

The concept for commercial propellant production and distribution we have described in this paper is based on the adaptation of existing technologies—hardware, software, and operational concepts. The basic science of extraction, processing, transport, storage, and delivery systems exist. Their application to a low gravity, cold lunar crater environment using only robotics for maintenance is the great challenge. Technology development effort for the project should follow three tracks:

- Detailed modular design concepts for extraction and transport, based on information gained from precursor prospecting and environmental characterization missions
- Detailed modular concepts for power, processing, storage and delivery, that modify terrestrial system components for space flight and the lunar environment
- Algorithms and software that automate all phases of the project

The “modular” requirement for system parts comes from the need to assemble, maintain and repair everything using robots. Modularity simplifies robotic hardware and software, and it makes parts storage and delivery much more flexible.

---

<sup>248</sup> Section Author: Mark Sundahl, Cleveland State University, Cleveland-Marshall School of Law Professor

<sup>249</sup> Section Author: Gordon Roesler, Robots in Space LLC, President

### **Leverage Existing Systems<sup>250</sup>**

The lunar propellant plant is similar in many ways to chemical plants on Earth. All such plants have chambers where the essential chemistry takes place; tanks for holding feedstock, intermediate and final products; plumbing and vehicles for moving products around the facility; power supplies and distribution; and control systems that automate most of the processes and actuate safety features. To re-engineer a terrestrial chemical plant for the lunar propellant application, major tasks will include:

- **Modularization.** Chemical plants are often highly integrated, with large components weighing several tons. A lunar plant design will need to be broken into smaller parts that can be robotically moved from the landing site to the installation site, and robotically assembled with ease.
- **Weight reduction.** Builders of terrestrial plants are relatively unconstrained by the masses of components, other than limits of available lifting gear. Because launch and space transport are highly weight-constrained, designers should consider options such as operation at lower pressures (which reduces the weight of chambers and pipes), even if some reduction in efficiency would occur.
- **Safety in design.** Some properties of the lunar environment pose hazards to which terrestrial plants are not exposed. Most important are radiation and micrometeorites. Plant systems must be tolerant to these hazard sources.
- **Redundancy and sparing.** Investors, insurers, and customers will insist on a high level of assurance that production will be continuous and reliable. Repair times will be much more dependent on redundancy and sparing than for terrestrial plants. Having to wait for component delivery from Earth to restore production after a failure will be unattractive to investors. On-site spares, redundant components, automated responses, and robotic services will be key.

### **Apply Automation<sup>251</sup>**

Robotic operations follow one of four general modes: scripted, teleoperated, supervised autonomy and full autonomy. Choice of which mode to use depends on the availability of information (e.g. positions and orientation of components) and connectivity. Design of the lunar propellant installation will assign these modes to the various robotic operations during site preparation, construction, operation, maintenance, and repair. Fully autonomous operation sounds difficult, but it has been demonstrated in space<sup>252</sup>. Other automation features that need to be included in the design will be:

- **Fault detection, identification and response.** Robots will encounter components that are not in the nominal configuration (e.g. bent connectors). They themselves will also experience failures (e.g. electrical shorts, suspension problems). If such anomalies can be resolved without involving humans on Earth, the efficiency will be greatly improved.
- **Process monitoring and control.** Terrestrial chemical plants often include human oversight, both in control centers and around the plant. Lunar plant control must be completely automated, because the facility will have only intermittent connectivity with humans on Earth or at NRHO (which will only be intermittently occupied in any event). Without fully automated operation, failures that occur at times without human oversight could propagate and have serious consequences.

### **Establish Standards<sup>253</sup>**

Each subsystem of the lunar extraction and production facility will have to interface with other systems throughout its life cycle. These interfaces should be standardized in order to reduce costs (Standards as Cost

---

<sup>250</sup> Section Author: Gordon Roesler, Robots in Space LLC, President

<sup>251</sup> Section Author: Gordon Roesler, Robots in Space LLC, President

<sup>252</sup> <https://ti.arc.nasa.gov/tech/asr/groups/planning-and-scheduling/remote-agent/>

<sup>253</sup> Section Authors: Gordon Roesler, Robots in Space LLC, President; and Dallas Bienhoff, Cislunar Space Development Company LLC, Founder

Savings) and improve efficiency. The overall complexity of this facility is comparable to that of the ISS. Even on ISS, examples such as NASA’s International Docking System (IDS) demonstrate the necessity of standardization in space. A list of interfaces that must be considered in the design of the lunar propellant plant includes:

- Pre-launch interfaces with ground support equipment (mechanical and electrical)
- Launch vehicle interface (launch restraints, restraint release power, telemetry)
- Lunar lander interface (at least mechanical)
- Interface with transport robot (at least mechanical, probably also power for survival heat)
- Interfaces with other facility subsystems (mechanical, power, control, telemetry, fluids, thermal)

A design challenge for most components will be the wide variety of environments that they experience—launch vibrations, landing forces, lunar day and night, abrasion from regolith, transport by robot and in some cases the extreme cold of the shadowed craters. The interface designs will be driven by the need to accommodate all of these environments.

Propellant transfer interfaces need multiple fluid paths, mechanical, power, data and command interfaces as well. Any space vehicle receiving or transferring lunar propellant will need a fuel and an oxidizer interface for primary and attitude control propellants. There may also be a need to exchange ullage as well as propellant. As described in the Rendezvous and Capture section, Altius Space Machines has a Phase II SBIR to develop a cryogenic transfer interface. Implementing these types of interfaces as standards is crucial to efficient implementation of the lunar propellant architecture.

The benefit of standardizing these interfaces includes simplicity of planning, reduced cost, and enhanced reliability. Relevant research is being performed by the DLR for modular design of satellites. In a project called Intelligent Building Blocks for On-Orbit Satellite Servicing and Assembly (iBOSS)<sup>254</sup>, an Intelligent Space System Interface has been developed. Potentially, generalizing such promising interface designs may be greatly beneficial in engineering the assembly of the lunar plant.

However, there is a danger to overly specific interface standardization, namely the potential inability to accommodate new features. An insight may be drawn from the 120V wall plug. It is a standardized design, but does not greatly constrain the equipment that it powers. “Flexible standardization” is the ideal approach for a system of the complexity of the lunar propellant plant.

### **Path Forward**<sup>255</sup>

A commercial lunar propellant system will be a vast undertaking. A phased approach is recommended, each phase serving to increase maturity of the technologies, attract increased levels of investment, and develop markets and customers. An example of a phased development program is:

- Phase 0: Establish business viability. In order to secure adequate funding, the following items must be completed prior to, or in parallel with, to the subsequent phases:
  - NASA and others propose propellant demand, price, and location of use as customer base
  - Prospecting and science exploration of lunar polar regions
  - Improved space law to facilitate commercial utilization of lunar resources
  - Commercial lunar propellant companies form for managing the many subcontractors
  - Third party high fidelity financial models
  - Secure investment for technology development and maturity

---

<sup>254</sup> [http://www.iboss-satellites.com/fileadmin/Templates/iBOSS\\_Satellites/Media/iBOSS\\_Concept.pdf](http://www.iboss-satellites.com/fileadmin/Templates/iBOSS_Satellites/Media/iBOSS_Concept.pdf)

<sup>255</sup> Section Authors: Gordon Roesler, Robots in Space LLC, President; and David Kornuta, United Launch Alliance, CisLunar Project Lead

- Technology applied to terrestrial markets to generate revenue
  - Implementation of international lunar communications architecture
- Phase I: Individual technology demonstrations. Organizations will continue to raise the TRL of critical hardware elements through technology demonstrations. This phase can be greatly accelerated with PPP:
  - Demonstrating sublimation from regolith simulant
  - Robotic demonstrations of plant assembly techniques
  - Reusable lunar lander development
  - Hydrogen/oxygen-fueled vehicles for operations in Earth orbit, such as LEO-to-GEO tugs
  - Additional technology demonstrations outlined within previous sections of this study
- Phase II: Subscale terrestrial demonstration plant. Although conducted on Earth, elements of this IST could be conducted in simulated Permanently Shadowed Regions (PSR) environments including:
  - Assembly demonstrations of all components of the plant
  - Robotic operations in cryogenic conditions
  - Efficient subscale processing plant with lightweight components
  - System interface validation
  - Vacuum chamber IST with cold wall for end-to-end system verification
- Phase III: Subscale lunar production plant. The following activities will boost the TRL of the integrated lunar propellant production plant to 9:
  - May be scaled to fit on a single launch vehicle for delivery to PSR
  - Designed for limited operations or production
  - Demonstrates collection, transport, processing, and storage of cryogenic propellant
  - Propellant produced can support robotic exploration and sample return missions
  - Becomes seed for full-scale production plant
- Phase IV: Full-scale commercial lunar production facility. Initiates US industrialization on another terrestrial body. Establishes sustained presence on the Moon.
  - Technology has been fully vetted
  - Customer base is well established
  - Required resource mapping complete
  - Investment has been secured
  - The legal framework is in place
  - All infrastructure is delivered to the lunar surface
  - Full-scale propellant production in support of space missions underway
  - Transport from lunar surface to space is in place
- Phase V: Iterative system enhancement. In the decades following the establishment of the lunar propellant plant, new technologies will be integrated into the system to improve performance, decrease operating costs, and enable effective utilization of its products.
  - Utilization of lunar propellant to expand the facility (Bootstrapping Deployment section)
  - Installation of tracks and roadways for robotic operations (Surface Mobility section)
  - Propellantless ascent systems for delivery to orbit (Propellantless Ascent section)
  - Efficient LEO delivery (Aerobraking/Aerocapture for LEO Delivery section)
  - Unforeseen new technologies driven by healthy commercial competition to innovate
- Phase ∞: Well established lunar propellant industry. The Moon and its resources become a gateway to the solar system. Its resources are used for space exploration as well as to benefit life on Earth.
  - Robust and highly scalable space economy (Enabled Industries section)
  - Improved scientific understanding of the Moon and beyond (Science Benefits sections)
  - Enables solutions to Earth's energy crisis (Energy section)
  - Supports space habitation (Supporting Human Settlement and Existential Threats sections)
  - Is the first step in humanity's journey through the cosmos (Grand Science and Exploration)

Establishing a commercial lunar propellant plant is fundamental to the exponential growth and prosperity of humankind. This effort requires industry, government, and academic collaboration on a scale more extensive than humanity's greatest historic engineering achievements. Like those achievements, the challenge is great but the value is even greater. Producing far more than just near term economic gains, this Commercial Lunar Propellant Architecture enables entirely new opportunities for human civilization.



## References



- [1] C. T. Pillinger, P. Davis, G. Eglinton, A. P. Gowar, A. J. T. Juli, J. R. Maxwell, R. M. Housley and E. H. Cirlin, "The association between carbide and finely divided metallic iron in lunar fines," in *Proc. Lunar Sci. Conf. 5th, 1949-1961*, 1974.
- [2] R. V. Morris, "Surface exposure indices of lunar soils: A comparative FMR study," in *Proc. Lunar Sci. Conf. 7th, 315-335*, 1976.
- [3] G. Heiken, D. Vaniman and B. French, "Lunar Source Book: A User's Guide to the Moon," Cambridge University Press, Cambridge, MA (736 pp.), 1991.
- [4] L. Wilson and J. W. Head, "Deep generation of magmatic gas on the Moon and implications for pyroclastic eruptions," *Geophysics Research Letters*, vol. 30, no. 12, 1605, doi:10.1029/2002GL016082, 2003.
- [5] A. E. Saal, E. H. Hauri, M. L. Cascio, J. A. Van Orman, M. J. Rutherford and R. F. Cooper, "Volatile content of lunar volcanic glasses and the presence of water in the Moon's interior," *Nature*, no. 454, pp. 192-195, 2008.
- [6] E. H. Hauri, T. Weinreich, A. E. Saal, M. C. Rutherford and J. A. Van Orman, "High pre-eruptive water contents preserved in lunar melt inclusions," *Science*, no. 333, pp. 213-215, 2011.
- [7] E. H. Hauri, A. E. Saal, M. J. Rutherford and J. A. Van Orman, "Water in the Moon's interior: Truth and consequences," *Earth and Planetary Science Letters*, no. 409, pp. 252-264, 2015.
- [8] R. E. Milliken and S. Li, "Remote detection of widespread indigenous water in lunar pyroclastic deposits," *Nature Geoscience*, no. 10, pp. 561-565, 2017.
- [9] S. Nozette, C. Lichtenberg, P. Spudis, R. Bonner, W. Ort, E. Malaret, M. Robinson and E. M. Shoemaker, "The Clementine bistatic radar experiment," *Science*, no. 274, p. 1495-1498, 1996.
- [10] S. Nozette, P. D. Spudis, M. Robinson, D. B. J. Bussey, C. Lichtenberg and R. Bonner, "Integration of lunar polar remote-sensing data sets: Evidence for ice at the lunar south pole," *Journal of Geophysical Research*, vol. 106, no. 19, pp. 23,253-23,266, 2001.
- [11] W. C. Feldman, S. Maurice, A. B. Binder, B. L. Barraclough, R. Elphic and D. J. Lawrence, "Fluxes of fast and epithermal neutrons from lunar prospector: Evidence for water ice at the lunar poles," *Science*, no. 281, p. 1496-1500, 1998.
- [12] W. C. Feldman, D. J. Lawrence, R. C. Elphic, B. L. Barraclough, S. Maurice, I. Genetay and A. B. Binder, "Polar hydrogen deposits on the Moon," *Journal of Geophysical Research*, no. 105, pp. 4175-4195, 2000.
- [13] R. C. Elphic, V. R. Eke, L. F. A. Teodoro, D. J. Lawrence and D. B. J. Bussey, "Models of the distribution and abundance of hydrogen at the lunar south pole," *Geophysical Research Letters*, vol. 34, no. L13204, doi:10.1029/2007GL029954, 2007.

- [14] A. Colaprete, P. Schultz, J. Heldmann, D. Wooden, M. Shirley, K. Ennico, B. Hermalyn and e. al., "Detection of Water in the LCROSS Ejecta Plume," *Science*, vol. 330, no. 6003, pp. 463-468, 2010.
- [15] C. D. Neish, D. B. J. Bussey, P. D. Spudis, W. Marshall, B. J. Thomson, G. W. Patterson and L. M. Carter, "The nature of lunar volatiles as revealed by Mini-RF observations of the LCROSS impact site," *Journal of Geophysical Research*, vol. 116, no. E01005, doi:10.1029/2010JE003647, 2011.
- [16] P. Spudis, D. Bussey, S. Baloga, J. Cahill, L. Glaze, G. Patterson, R. Raney, T. Thompson, B. Thomson and E. Ustinov, "Evidence of Water Ice on the Moon: Results for Anomalous Polar Craters from the LRO Mini-RF Imaging Radar," *Journal of Geophysical Research: Planets*, vol. 118, no. 10, pp. 2016-2029, 2013.
- [17] G. W. Patterson and e. al., "Bistatic radar observations of the Moon using Mini-RF on LRO and the Arecibo Observatory," *Icarus*, no. 283, pp. 2-19, 2017.
- [18] I. Mitrofanov and e. al., "Testing polar spots of water-rich permafrost on the Moon: LEND observations onboard LRO," *Journal of Geophysical Research*, vol. 117, no. E00H27, doi:10.1029/2011JE003956, 2012.
- [19] LEAG, "Volatiles Specific Action Team: Final Report," 2014. [Online]. Available: [https://www.lpi.usra.edu/leag/reports/vsat\\_report\\_123114x.pdf](https://www.lpi.usra.edu/leag/reports/vsat_report_123114x.pdf).
- [20] A. Colaprete, R. C. Elphic, J. Heldmann and K. Ennico, "An overview of the Lunar Crater Observation and Sensing Satellite (LCROSS)," *Space Science*, no. 167, pp. 3-22, 2012.
- [21] P. G. Lucey and e. al., "The global albedo of the Moon at 1064 nm from LOLA," *Journal of Geophysical Research*, no. 119, pp. 1665-1679, 2014.
- [22] E. A. Fisher and e. al., "Evidence for surface water ice in the lunar polar regions using reflectance measurements from the Lunar Orbiter Laser Altimeter and temperature measurements from the Diviner Lunar Radiometer Experiment," *Icarus*, no. 292, pp. 74-85, 2017.
- [23] G. R. Gladstone and e. al., "Far-ultraviolet reflectance properties of the Moon's permanently shadowed regions," *Journal of Geophysical Research*, vol. 117, no. E00H04, doi:10.1029/2011JE003913, 2012.
- [24] P. O. Hayne, A. Hendrix, E. Sefton-Nash, M. A. Siegler, P. G. Lucey, K. D. Retherford, J.-P. Williams, B. T. Greenhagen and D. A. Paige, "Evidence for exposed water ice in the Moon's south polar regions from Lunar Reconnaissance Orbiter ultraviolet albedo and temperature measurements," *Icarus*, no. 255, pp. 58-59, 2015.
- [25] S. Li, P. G. Lucey, R. E. Milliken, P. O. Hayne, E. Fisher, J.-P. Williams, D. M. Hurley and R. C. Elphic, "Direct evidence of surface exposed water ice in the lunar polar regions," *Proc. Nat. Acad. Sciences*, 2018.
- [26] M. A. Siegler, R. S. Miller, J. T. Keane, M. Laneuville, D. A. Paige, I. Matsuyama, D. J. Lawrence, A. Crotts and M. J. Poston, "Lunar true polar wander inferred from polar hydrogen," *Nature*, no. 531, pp. 480-484, 2016.

- [27] G. Paulsen, Z. Mank, A. Wang, P. Chow, C. Hyman, T. Thomas, A. Lee, K. Zacny, J. Smith, J. Quinn, E. Mumm and R. Hayes, "The Regolith and Ice Drill for Exploration of New Terrains (TRIDENT); a One-Meter Drill for the Lunar Resource Prospector Mission, NASA/CP-2018-219887," in *44th Aerospace Mechanisms Symposium*, Cleveland, OH, 2018.
- [28] L. Teodoro, R. Elphic, A. Colaprete, T. Roush, J. Kleinhenz, J. Smith, A. Cook and K. Zacny, "Modeling of Volatiles Loss During Lunar Resource Prospector Mission Sample Acquisition," in *49th Lunar and Planetary Science Conference*, The Woodlands, TX, 2018.
- [29] D. Andrews, "A Lunar Volatiles Prospecting and In-Situ Resource Utilization (ISRU) Demonstration Mission," in *IEEE Robotics and Automation Society*, Menlo Park, CA, 2016.
- [30] G. R. Gladstone, D. M. Hurley, K. D. Retherford, P. D. Feldman, W. R. Pryor, J.-Y. Chaufray, M. Versteeg and e. al., "LRO-LAMP Observations of the LCROSS Impact Plume," *Science*, vol. 330, no. 6003, pp. 472-476, 2010.
- [31] D. Hurley, A. Colaprete, R. Elphic, W. Farrell, P. Hayne, J. Heldmann., C. Hibbits, T. Livengood, P. Lucey, K. Klaus, D. King, W. Patterson and B. Sherwood, "Lunar Polar Volatiles: Assessment of Existing Observations for Exploration," NASA Goddard Space Flight Center, 2016. [Online]. Available: [5https://ssed.gsfc.nasa.gov/dream/docs/PolarVolatiles\\_HEOMD\\_Hurley.pdf](https://ssed.gsfc.nasa.gov/dream/docs/PolarVolatiles_HEOMD_Hurley.pdf). [Accessed 4 October 2017].
- [32] K. Zacny, K. Luczek, A. Paz and M. Hedlund, "Planetary Volatiles Extractor (PVEx) for In-Situ Resource Utilization (ISRU)," in *15th Biennial Conference on Engineering, Science Construction, and Operations in Challenging Environments*, Orlando, FL, 2016.
- [33] K. Zacny, P. Chu, G. Paulsen, A. Avanesyan, J. Craft and L. Osborne, "Mobile In-Situ Water Extractor (MISWE) for Mars, Moon, and Asteroids In-Situ Resource Utilization," in *AIAA Space Conference & Exhibition*, Pasadena, CA, 2012.
- [34] Vendiola and e. al., "Testing of Planetary Volatiles Extraction (PVEx)," in *ASCE Earth & Space Conference*, Cleveland, OH, 2018.
- [35] K. Zacny, P. Metzger, K. Luczek, J. Mantovani, R. Mueller and J. Spring, "The World is Not Enough (WINE): Harvesting Local Resources for Eternal Exploration of Space," in *AIAA Space*, Long Beach, CA, 2016.
- [36] K. Zacny, G. Paulsen, B. Yaggi, D. Wettergreen and N. Cabrol, "Life in the Atacama (LITA) Drill and Sample Delivery System: Results from the Field Campaigns," in *Astrobiology Science Conference*, Chicago, IL, 2015.
- [37] G. Paulsen, Z. Mank, A. Wang, P. Chow, C. Hyman, T. Thoma, A. Lee, K. Zacny, J. Smith, J. Quinn, E. Mumm and R. Hayes, "NASA/CP-2018-219887," in *44th Aerospace Mechanisms Symposium*, Cleveland, OH, 2018.
- [38] D. Mitchell and I. de Pater, "Microwave Imaging of Mercury's Thermal Emission at Wavelengths from 0.3 to 20.5 cm," *Icarus*, no. 110, pp. 2-32, 1994.

- [39] A. Vasavada, D. Paige and S. Wood, "Near-Surface Temperatures on Mercury and the Moon and the Stability of Polar Ice Deposits," *Icarus*, vol. 141, no. 2, pp. 179-193, 1999.
- [40] A. Vasavada, J. Bandfield, B. Greenhagen, P. Hayne, M. Siegler and J. P. D. Williams, "Lunar Equatorial Surface Temperatures and Regolith Properties from the Diviner Lunar Radiometer Experiment," *Journal of Geophysical Research: Planets*, vol. 117, no. 12, 2012.
- [41] P. Metzger, C. Immer, C. Donahue, B. Vu, R. Latta III and M. Deyo-Svendsen, "Jet-Induces Cratering of Granular Surface with Application to Lunar Spaceports," *Journal of Aerospace Engineering*, vol. 22, no. 1, pp. 24-32, 2009.
- [42] C. B. Dreyer, G. Sowers and H. Williams, "Ice Mining in Lunar Permanently Shadowed Regions," in *Space Resources Roundtable XIX / Planetary & Terrestrial Mining Sciences Symposium*, Golden, CO, June 12-14, 2018.
- [43] K. J. Kossacki and J. Leliwa-Kopystynski, "Temperature dependence of the sublimation rate of water ice: Influence of impurities," *Icarus*, no. 233, pp. 101-105, 2014.
- [44] E. L. Andreas, "New estimates for the sublimation rate for ice on the Moon," *Icarus*, vol. 186, no. 1, pp. 24-30, 2007.
- [45] L. Kelsey and e. al, "Contaminant Robust Water Extraction from Lunar and Martian Soil for In Situ Resource Utilization - System Testing, AIAA 2013-3438," in *43rd International Conference on Environmental Systems*, Vail, CO, July 2013.
- [46] L. Kelsey and e. al, "Closing the Water Loop for Exploration: Status of the Brine Processor Assembly, ICES-2017-225," in *47th International Conference on Environmental Systems*, Charleston, SC, July 2017.
- [47] B. Finger and e. al, "Development of a Hybrid Integrated Water Recovery ASsembly for Exploration Habitats, ICES-2018-269," in *48th International Conference on Environmental Systems*, Albuquerque, NM, July 2018.
- [48] J. M. Free and e. al, "Concept Design of Cryogenic Propellant Storage and Transfer for Space Exploration," in *63rd International Astronautical Congress*, Naples, Italy, 2012.
- [49] M. Zagarola and e. al, "Demonstration of a Two-Stage Turbo-Brayton Cryocooler for Space," in *International Cryocooler Conference*, Boulder, CO, 2009.
- [50] M. Moran, "Conceptual Study Of On Orbit Production Of Cryogenic Propellants By Water Electrolysis," in *27th Joint Propulsion Conference*, Sacramento, CA, 24-26 June 1991.
- [51] N. Yastrebova, "High-efficiency multi-junction solar cells: current status and future potential," Centre for Research in Photonics, University of Ottawa, Ottawa, ON, Canada, 2007.
- [52] J. Barbee, "Could this be the world's most efficient solar electricity system?," *The Guardian*, 21 April 2017.

- [53] S. Sandia, "Sandia National Laboratories Information System," National Technology and Engineering Solutions of Sandia, LLC, 12 February 2008. [Online]. Available: Share.sandia.gov. [Accessed 22 April 2013].
- [54] G. P. Barnhard and D. Faber, "Space-to-Space Power Beaming (SSPB): A Commercial ISS Technology Development, Demonstration, and Deployment (TD3) Mission," *NSS Space Settlement Journal*, 2017.
- [55] R. M. Dickinson, "Wireless "Power Transmission Technology State of the Art, the first Bill Brown Lecture"," *Acta Astronautica*, no. 53, p. 561-570, 2003.
- [56] J. McSpadden and J. Mankins, "Space Solar Power Programs and Microwave Wireless Power Transmission Technology," *IEEE Microwave Magazine*, December 2002.
- [57] N. Fatemi, H. Pollard, H. Hou and Sharps, "Solar Array Trades Between Very High-Efficiency Multi-Junction and Si Space Solar Cells," in *IEEE PVSC*, Anchorage, AK, 2000.
- [58] G. A. Landis, ""Prospects for Solar Pumped Semiconductor Lasers" Paper SPIE 2121-09, Laser Power Beaming, SPIE Proceedings Volume 2121, pp. 58-65 (1994)," in *SPIE Optics, Electro-optics & Laser Conference*, Los Angeles, CA, 1994.
- [59] L. L. Vant-Hull and M. Becker, "Thermal Receivers," in *Solar Power Plants*, Berlin, Springer Verlag, 1991, pp. 163-198.
- [60] A. Rabl, *Active Solar Collectors and Their Applications*, New York: Oxford University Press, 1985.
- [61] N. Kincaid and e. al, "An Optical Performance Comparison of Three Concentrating Solar Power Collector Designs in Linear Fresnel, Parabolic Trough, and Central Receiver," 2018.
- [62] International Atomic Energy Agency, "The Role of Nuclear Power and Nuclear Propulsion in the Peaceful Exploration of Space," Vienna, 2005.
- [63] D. T. Palac, M. A. Gibson, L. S. Mason, P. McClure and R. C. Robinson, "KILOPOWER KRUSTY FISSION POWER DEMONSTRATION UPDATE," in *ANS NETS 2018 - Nuclear and Emerging Technologies for Space*, 2018, pp. 1-5.
- [64] M. A. Gibson, S. Oleson, D. I. Poston and P. McClure, "NASA's Kilopower reactor development and the path to higher power missions," in *IEEE Aerospace Conference Proceedings*, 2017.
- [65] K. R. Supak, "REDUCED GRAVITY RANKINE CYCLE SYSTEM DESIGN AND OPTIMIZATION STUDY WITH PASSIVE VORTEX PHASE SEPARATION," Texas A&M University, 2007.
- [66] L. Mason, "High-Power Nuclear Electric Systems," 2018.
- [67] M. Gibson, L. Mason, M. Houts, P. McClure and R. Robinson, "Kilopower Technology Demonstration – Overall Objectives & Elements & Goals," 2017.

- [68] U.S. Department of Energy, "Nuclear Safety Criteria and Specifications for Space Nuclear Reactors," 1982.
- [69] The White House, "Presidential Directive/NSC-25," 1977.
- [70] G. L. Bennett, "A Technical Review of the U.N. Principles on the Use of Nuclear Power Sources in Outer Space," 1995.
- [71] United Nations General Assembly, "UNITED NATIONS TREATIES AND PRINCIPLES ON OUTER SPACE," 2002.
- [72] "Space Policy Directive-2, Streamlining Regulations on Commercial Use of Space," 2018.
- [73] D. J. Trump, "Space Policy Directive-3 , National Space Traffic Management Policy," 2018, pp. 1-13.
- [74] The Senate of the United States of America, "Space Frontier Act of 201," 2018.
- [75] The Senate of the United States, "American Space Commerce Free Enterprise Act," 2018.
- [76] Federal Aviation Administration, "Fact Sheet – Moon Express Payload Review Determination," 2016. [Online]. Available: [https://www.faa.gov/news/fact\\_sheets/news\\_story.cfm?newsId=20595](https://www.faa.gov/news/fact_sheets/news_story.cfm?newsId=20595). [Accessed 14 August 2018].
- [77] G. Roesler, G. Henshaw and P. Jaffe, "Inside DARPA's Mission to Send a Repair Robot to Geosynchronous Orbit," *IEEE Spectrum*, March 2017.
- [78] A. Bretton, "Hearing on Private Sector Lunar Exploration," in *House Subcommittee on Space* , September 7, 2017.
- [79] T. Cichana, S. A. Bailey, A. Burchc and N. W. Kirbyd, "Concept for a Crewed Lunar Lander Operating from the Lunar Orbiting Platform-Gateway," in *69th International Astronautical Congress (IAC)*, Bremen, Germany, 1-5 October 2018.
- [80] Z. Chen, H. Chen and K. Ho, "Analytical Optimization Methods for Space Logistics," *Journal of Spacecraft and Rockets*.
- [81] H. Chen and K. Ho, "Integrated Space Logistics Mission Planning and Spacecraft Design with Mixed-Integer Nonlinear Programming," *Journal of Spacecraft and Rockets*, vol. 55, no. 2, pp. 365-381, 2018.
- [82] K. Ho, O. de Weck, J. Hoffman and R. Shishko, "Campaign-Level Dynamic Network Modelling for Spaceflight Logistics for the Flexible Path Concept," *Acta Astronautica*, vol. 123, pp. 51-61, 2016.
- [83] K. Ho, O. de Weck, J. Hoffman and R. Shishko, "Dynamic Modeling and Optimization for Space Logistics Using Time-Expanded Networks," *Acta Astronautica*, vol. 105, no. 2, pp. 428-443, 2014.
- [84] K. Ho, "Transportation Network Design Optimization for Cis-Lunar Space Economy (Phase I)," 2016.

- [85] K. Ho, "Transportation Network Design Optimization for Cis-Lunar Space Economy (Phase II)," 2017.
- [86] P. T. Metzger, J. E. Lane, C. D. Immer and S. Clements, "Cratering and Blowing Soil by Rocket Engines During Lunar Landings," in *Lunar Settlements*, ed. by Haym Benaroya, CRC Press, 2010, pp. 551-576.
- [87] P. T. Metzger, J. Smith and J. E. Lane, "Phenomenology of Soil Erosion by Rocket Exhaust on the Moon and the Mauna Kea Lunar Test Site," *Journal of Geophysical Research – Planets*, vol. 116, no. E06005, June 2011.
- [88] J. E. Lane and P. T. Metzger, "Estimation of Apollo lunar dust transport using optical extinction measurements," *Acta Geophysica*, vol. 63, no. 2, pp. 568-599, 2014.
- [89] C. D. Immer, J. E. Lane, P. T. Metzger and S. Clements, "Apollo Video Photogrammetry Estimation of Plume Impingement Effects," *Icarus*, vol. 214, pp. 46-52, July, 2011.
- [90] J. E. Lane, P. T. Metzger and C. D. Immer, "Lagrangian trajectory modeling of lunar dust particles," in *Proceedings of the 11th Biennial ASCE Aerospace Division International Conference on Engineering, Construction and Operations in Challenging Environments*, Long Beach, California, Mar. 3-5, 2008.
- [91] J. E. Lane, P. T. Metzger and J. W. Carlson, "Lunar Dust Particles Blown By Lander Engine Exhaust in Rarefied and Compressible Flow," in *Proceedings of Earth and Space 2010, 12th Biennial ASCE Aerospace Division International Conference on Engineering, Construction and Operations in Challenging Environments*, Honolulu, HI, Mar. 14-17, 2010.
- [92] NASA Manned Space Center, "Rep. MSC-276," in *Apollo 11 technical debriefing v. 1 and 2*, Houston, Texas, NASA Manned Space Center, 1969, pp. 9.24–9.28, and 12.3–12.12.
- [93] J. E. Lane and P. T. Metzger, "Ballistics Model for Particles on a Horizontal Plane in a Vacuum Propelled by a Vertically Impinging Gas Jet," *Particulate Science and Technology*, vol. 30, no. 2, pp. 196-208, 2012.
- [94] A. C. Wittbrodt and P. T. Metzger, "Material Damage from Impacts of Lunar Soil Particles Ejected by the Rocket Exhaust of Landing Spacecraft," NASA Technical Report KSC-2008-290, 2008.
- [95] R. N. Clegg, P. T. Metzger, S. Huff and L. B. Roberson, "Lunar soil erosion physics for landing rockets on the Moon, paper no. 4122," in *Proceedings of the Joint Annual Meeting of the Lunar Exploration Analysis Group (LEAG), the International Lunar Exploration Working Group (ILEWG) Conference on Exploration and Utilization of the Moon (ICEUM) and the Space Resources Roundtable (SRR)*, Cape Canaveral, Florida, October 28-31, 2008.
- [96] C. D. Immer, P. Metzger, P. Hintze, A. Nick and R. Horan, "Apollo 12 Lunar Module Exhaust Plume Impingement on Lunar Surveyor III," *Icarus*, vol. 211, no. 2, pp. 1089-1102, February 2011.

- [97] P. v. Susante and P. T. Metzger, "Design, Test and Simulation of Lunar and Mars Landing Pad Soil Stabilization Built with In-Situ Rock Utilization," in *Earth and Space 2016: Engineering, Science, Construction, and Operations in Challenging Environments*, Orlando, FL, April 11-15, 2016.
- [98] D. J. Smith, L. B. Roberson, R. Mueller and P. Metzger, "Rapidly deployable blast barriers for lunar surface operations, paper no. 4045," in *Joint Annual Meeting of the Lunar Exploration Analysis Group (LEAG), the International Lunar Exploration Working Group (ILEWG) Conference on Exploration and Utilization of the Moon (ICEUM) and the Space Resources Roundtable (SRR)*, Cape Canaveral, Florida, October 28-31, 2008.
- [99] J. Gamsky and P. T. Metzger, "The Physical State of Lunar Soil in the Permanently Shadowed Craters of the Moon," in *Earth and Space 2010: Engineering, Science, Construction, and Operations in Challenging Environments*, Honolulu, HI, Mar. 14-17, 2010.
- [100] P. T. Metzger, S. Anderson and A. Colaprete, "Experiments and Modeling Indicate Regolith is Looser in the Lunar Polar Regions Compared to Regolith at the Lunar Landing Sites," in *Earth and Space 2018: Engineering, Science, Construction, and Operations in Challenging Environments*, Cleveland, OH, April 9-12, 2018.
- [101] P. Hayne, "Regolith properties in the Moon's permanently shadowed regions from Diviner temperature measurements," in *Polar Regolith: Workshop Without Walls*, NASA SSERVI, December 3, 2015.
- [102] P. H. Schultz, B. Hermalyn, A. Colaprete, K. Ennico, M. Shirley and W. S. Marshall, "The LCROSS cratering experiment," *Science*, vol. 330, no. 6003, pp. 468-472, 2010.
- [103] R. Mueller, J. Schuler, A. Nick, A. Wilkinson, C. Gallo and R. King, "Lightweight bulldozer attachment for construction and excavation on the lunar surface," in *AIAA SPACE 2009 Conference & Exposition*, p. 6466, 2009.
- [104] P. Hintze, J. Curran and T. Back, "Lunar surface stabilization via sintering or the use of heat cured polymers," in *47th AIAA Aerospace Sciences Meeting including The New Horizons Forum and Aerospace Exposition*, 2009.
- [105] P. E. Hintze, "Building a vertical take off and landing pad using in situ materials," in *Space Manufacturing 14*, 2010, pp. 29-31.
- [106] P. E. Hintze and S. Quintana, "Building a lunar or Martian launch pad with in situ materials: Recent laboratory and field studies," *Journal of Aerospace Engineering*, vol. 26, no. 1, pp. 134-142, 2012.
- [107] S. M. Allan, B. J. Merritt, B. F. Griffin, P. E. Hintze and H. S. Shulman, "High-temperature microwave dielectric properties and processing of JSC-1AC Lunar Simulant," *Journal of Aerospace Engineering*, vol. 26, no. 4, pp. 874-881, 2013.
- [108] R. P. Mueller and R. H. King, "Trade study of excavation tools and equipment for lunar outpost development and ISRU," in *AIP Conference Proceedings*, vol. 969, no. 1, pp. 237-244, 2008.



- [109] J.-M. Gosau, "Regolith Stabilization and Building Materials for the Lunar Surface," in *In Earth and Space 2012: Engineering, Science, Construction, and Operations in Challenging Environments*, 2012, pp. 243-249.
- [110] B. Aldrin, A. C. Clarke, H. H. Schmitt, J. Young and e. al, "Earth Moon Transportation," in *The Lunar Base Handbook*, McGraw-Hill Companies, Inc., 2006, pp. 157-202.
- [111] G. Roesler, "Mass Estimate for a Lunar Resource Launcher Based on Existing Terrestrial Electromagnetic Launchers," *Machines*, vol. 1, no. 1, pp. 50-62, 2013.
- [112] D. Buden and e. al, "Selection of Power Plant Elements for Future Space Electric Power Systems," LA-7858, Los Alamos National Laboratory,, Los Alamos, New Mexico.
- [113] Team Explorer, "Lunar Extraction for Extra-Terrestrial Prospecting," CalTech Space Cahllenge - 2017, Pasadena, CA, 2017.
- [114] T. Cichan and e. al., "Mars Base Camp: An Architecture for Sending Humans to Mars," *New Space*, vol. 5, no. 4, December 1, 2017.
- [115] G. Sowers, "Closing the Business Case for Lunar Propellant," in *Space Resources Roundtable, Colorado School of Mines* , Golden, CO, 2018.
- [116] G. Sowers, "Creating the Cislunar Economy," in *University of North Dakota, Aerospace*, Grand Forks, ND, Feb 26. 2018.
- [117] NASA, "FY 2018 Budget Estimates," NASA, 2018.
- [118] NASA, "Extending the Operational Life of the International Space Station Until 2024," OFFICE OF INSPECTOR GENERAL, 2014.
- [119] CSTS, "Commercial Space Transportation Study, Phase 1 Study," NASA HQ by the Boeing Company, 1994 (Updated 1/4/97).
- [120] B. Blair, J. Diaz, M. Duke, E. Lamassoure, R. Easter, M. Oderman and M. Vaucher, "Space Resource Economic Analysis Toolkit: The Case for Commercial Lunar Ice Mining," NASA Exploration Team, Center for the Commercial Applications of Combustion in Space, Colorado School of Mines, Golden, Colorado, December 20, 2002.
- [121] E. L. Christiansen and e. al, "Conceptual design of a lunar oxygen pilot plant," in *Lunar Base Systems Study (LBSS) task 4.2, NASA-CR-172082*, Eagle Engineering, Jul 01, 1988, p. 270.
- [122] D. Smitherman, J. Fikes, S. Roy, M. Henley and S. Potter, "Space Resource Requirements for Future In-Space Propellant Production Depots," in *Space Resources Utilization Roundtable III*, Golden, CO, 24-26 Oct. 2001.
- [123] B. Ruiz and e. al, "Space Transportation Architectures and Refueling for Lunar and Interplanetary Travel and Exploration (STARLITE)," NASA GRANT NAG9-1535, Colorado School of Mines, June 6, 2005.

- [124] P. Troutman, "Orbital Aggregation & Space Infrastructure Systems (OASIS) Preliminary Architecture and Operations Analysis," NASA Revolutionary Aerospace Systems Concepts FY2001 Final Report, June 10, 2002.
- [125] tSpace, "Sustainable Lunar Exploration Requires a Competition-Based Open Architecture," in *CE&R Midterm Breifing*, Transformational Space Corporation, September 13, 2014.
- [126] A. Charania and D. DePasquale, "Economic Analysis of a Lunar In-Situ Resource Utilization (ISRU) Propellant Services Market," in *IAC-07-A5.1.03, 58th International Astronautical Congress*, Hyderabad, India, September 24-28, 2007.
- [127] F. Zegler and B. Kutter, "Evolving to a Depot-Based Space Transportation Architecture," in *AIAA 2010-8638, AIAA SPACE 2010 Conference & Exposition*, Anaheim, California, 30 August - 2 September 2010.
- [128] S. Erickson and e. al, "Lunar base scenario cost estimates," in *Lunar Base Systems Study (LBSS) task 6.1x, NASA-CR-172103*, Eagle Engineering, Inc., Oct 31, 1988, p. 294.
- [129] P. D. Spudis and A. R. Lavoie, "Using the resources of the Moon to create a permanent, cislunar space faring system - AIAA 2011-7185," in *AIAA SPACE 2011 Conference & Exposition*, Long Beach, 27 - 29 September 2011.
- [130] T. Lavoie and P. D. Spudis, "The Purpose of Human Spaceflight and a Lunar Architecture to Explore the Potential of Resource Utilization - AIAA 2016-5526," in *SPACE 2016 Conferences and Exposition*, 2016.
- [131] NASA, "Commercial Market Assessment for Crew and Cargo Systems Pursuant to Section 403 of the NASA Authorization Act of 2010 (P.L. 111-267)," NASA, April 27, 2011.
- [132] V. Foreman, J. Le Moigne and O. de Weck, "Satellite Constellation Cost Modeling: An Aggregate Model," in *Earth Science Techology Forum (ESTF)*, June 14, 2016.
- [133] A. Shao and e. al, "Quantifying the Cost Reduction Potential for Earth Observation Satellites - BIS-RS-2014-40," in *12th Reinventing Space Conference*, London, UK, 18-20 November 2014.
- [134] D. Risacher, "Cost As an Independent Variable (CAIV)," *JFDI: Just Do It blog*, 6 June 2016.
- [135] E. Casey and D. Allen, "Cost As An Independent Variable - Balancing Performance and Affordability," Raytheon Company, 2006.
- [136] M. Kaye, M. Sobota, D. Graham and A. Gotwald, "COST AS AN INDEPENDENT VARIABLE: PRINCIPLES AND IMPLEMENTATION," *Acquisition Review Quarterly*, 2000.
- [137] M. Soares and e. al, "An Approach for Automation the Satellite of Routine's - AIAA 2014-1846," in *AIAA SpaceOps 2014 Conferene*, Pasadena, CA, 5-9 May 2014.
- [138] D. Etherington, "Boeing wants to turn satellites into a cheaper, highly-automated business," *Techcrunch.com*, Feb 21, 2017.

- [139] B. Haldeman, "Using the Agile Approach for Lunar Settlement," *NewSpace*, vol. 4, no. 1, 2016.
- [140] DARPA, "DARPA Selects SSL as Commercial Partner for Revolutionary Goal of Servicing Satellites in GEO," *Press Release, News And Events*, 9 Feb 2017.
- [141] R. Reesman, "ASSURANCE THROUGH INSURANCE AND ON-ORBIT SERVICING - OTR201800240," Center for Space Policy and Strategy, The Aerospace Corporation, February, 2018.
- [142] V. Reddy, "The SpaceX Effect," *New Space*, vol. 6, no. 2, June 1, 2018.
- [143] D. E. Purcell, "Strategic Standard Setting on the Global Stage," ASSOCIATION MANAGEMENT, August 2004.
- [144] API, "The Value of Standards," American Petroleum Institute program information FAQ, API GLOBAL CREATIVE: 2012-328, 2014.
- [145] R. Philo, "Standards Deliver Cost Savings to the Oil & Gas Industry," CIOREVIEW, Oil & Gas, [Online]. Available: <https://oil-gas.cioreview.com/cxoinsight/standards-deliver-cost-savings-to-the-oil-gas-industry-nid-18495-cid-35.html>. [Accessed 18 March 2018].
- [146] SES, "SPELL: A Story of Vision, Innovation and Execution," *SES News*, 18 Mar 2015.
- [147] M. C. Blakey, "Easing the Burden: Reducing the cost of national security space capabilities," Aerospace Industries Association Special Report, February 2014.
- [148] House of Representatives, "Space Resource Exploration and Utilization Act," US Government, 2015.
- [149] T. Simmons, "Deploying the Common Law to Quasi-Marxist Property on Mars," *Gonzaga Law Review*, vol. 51, no. 1, December 17, 2015.
- [150] A. MacDonald, "Emerging Space: The Evolving Landscape of 21st Century American Spaceflight," NASA Office of the Chief Technologist, Aug 29, 2014.
- [151] R. F. Cordiner, "Competitive Private Enterprise in Space," *Peacetime Uses of Outer Space*, 1961.
- [152] J. Moore, "Predators and Prey: A New Ecology of Competition," *Harvard Business Review*, MAY-JUNE 1993, Reprint 93309.
- [153] F. Tran, S. Nahal, B. Ma, R. J. Epstein and B. Heelan, "Thematic Investing: To Infinity And Beyond – Global Space Primer," Bank of America Merrill Lynch Transforming World Thematic Research, 30 October 2017.
- [154] G. P. Barnhard, "Lunar Power & Light Company: Orchestrating the Technology Development, Demonstration, and Deployment (TD3) Missions needed to foster an electrical power and ancillary services utility for Cislunar space," in *International Solar Power Satellite Symposium & Workshop (SSP-2018) ISDC 2018*, , Los Angeles, California , May 23, 2018.

- [155] G. P. Barnhard, "Near Real-Time State Models: A foundational technology for space automation and robotics," in *ISS R&D Conference 2017*, Washington, DC, July 19, 2017.
- [156] S. P. Welby, "Modular Open Systems Architecture in DoD Acquisition," in *17th Annual NDIA Systems Engineering Conference*, Springfield, VA, October 29, 2014.
- [157] E. Musk, "Multiplanetary species," *NewSpace Journal*, 2017.
- [158] A. Dula and Z. Zhenjun, "Space Mineral Resources: Challenges and Opportunities," in *IAA Cosmic Study 3.17*, Heinlein Books, November, 2015, p. 396.
- [159] J. Bezos, Interviewee, *Jeff Bezos lays out Blue Origin's space vision, from tourism to off-planet heavy industry*. [Interview]. 23 April 2016.
- [160] C. F. Tolman, "Some Contributions to the Geologic Science by Economic Geologists," *Sigma Xi Quarterly*, vol. 27, no. 3, pp. 140-146, 1939.
- [161] E. R. Gantman, "Economic, linguistic, and political factors in the scientific productivity of countries," *Scientometrics*, vol. 93, no. 3, pp. 967-985, 2012.
- [162] P. T. Metzger, "Economic Planetary Science in the 21st Century, LPI Contributions no. 1989," in *NASA Vision 2050 Conference*, Washington, DC, 2017.
- [163] I. A. Crawford, "The long-term scientific benefits of a space economy," *Space Policy*, no. 37, pp. 58-61, 2016.
- [164] Semiconductor Industry Association; Semiconductor Research Corporation, "Rebooting the IT Revolution: A Call to Action," Semiconductor Industry Association, 2015.
- [165] J. Bongaarts, "Global Fertility and Population Trends," *Semin in Reproductive Medicine*, vol. 33, no. 1, pp. 5-10, 2015.
- [166] P. Gerland and e. al, "World Population Stabilization Unlikely this Century," *Science*, vol. 346, no. 6206, pp. 234-237, 2014.
- [167] R. Hanson, *The Age of Em*, Oxford, United Kingdom: Oxford University Press, 2016.
- [168] P. Metzger, A. Muscatello, R. Mueller and J. Mantovani, "Affordable, Rapid Bootstrapping of the Space Industry and Solar System Civilization," *Journal of Aerospace Engineering*, vol. 26, no. 1, pp. 18-29, 2013.
- [169] P. Metzger, "Space Development and Space Science Together, an Historic Opportunity," *Space Policy*, vol. 37, no. 2, pp. 77-91, 2016.
- [170] M. Elvis, T. Milligan and A. Krolikowski, "The Peaks of Eternal Light: a Near-term Property Issue on the Moon," Elsevier Ltd., 2016.
- [171] S. Shostak, "Forget Space Travel: Build this Telescope," SETI Institute, 2014.

- [172] G. Morris and G. Sowers, "Lunar Polar Prospecting Workshop: Findings and Recommendations," Colorado School of Mines, Golden, CO, August, 2018.
- [173] E. Zapata, "The Opportunity in Commercial Approaches for Future NASA Deep Space Exploration Elements," in *American Institute of Aeronautics and Astronautics Space 2017 Forum*, 2017.
- [174] A. Zuniga, D. Rasky, R. Pittman, E. Zapata and R. Lepsch, "Lunar COTS: An Economical and Sustainable Approach to Reaching Mars," AIAA, 2015.
- [175] A. B. Sanin and e. al., "Hydrogen distribution in the lunar polar regions," *Icarus*, no. 283, pp. 20-30, 2017.
- [176] *Missions – NASA Radioisotope Power Systems*.
- [177] *Ultra Safe Nuclear Corporation Homepage*, 2018.
- [178] L. S. Mason, "A Comparison of Fission Power System Options for Lunar and Mars Surface Applications," 2006.